



**FRESNO YOSEMITE**  
**International Airport**

**AIRPORT USE AND LEASE AGREEMENT**

**WITH**

**SOUTHWEST AIRLINES, CO.**

a Texas Corporation

## Contents

RECITALS.....	5
AGREEMENT .....	5
ARTICLE 1 - DEFINITIONS .....	5
Section 1.01 Meanings and Construction.....	5
Section 1.02 Interpretation .....	12
ARTICLE 2 - TERM OF THE AGREEMENT .....	13
Section 2.01 Term .....	13
Section 2.02 Condition Under Which the Agreement Becomes Effective .....	13
Section 2.03 Options to Extend .....	13
Section 2.04 Holding Over.....	14
ARTICLE 3 - AIRLINE RIGHTS, PRIVILEGES, AND LIMITATIONS.....	14
Section 3.01 Use of Airport.....	14
Section 3.02 Employee Parking Facilities .....	18
Section 3.03 Limitation on Use by Airline.....	18
Section 3.04 Airport Use Summary.....	20
Section 3.05 Airport Security .....	20
Section 3.06 Reassignment, Reallocation, Redesignation, Relocation and/or Recapture of Leased Premises.....	21
ARTICLE 4 - PREMISES .....	21
Section 4.01 General.....	21
Section 4.02 Leased Premises .....	21
Section 4.03 Aircraft Parking Areas: .....	22
Section 4.04 Use of Loading Bridges.....	23
Section 4.05 Accommodation in City-Controlled Facilities .....	23
Section 4.06 Aircraft Overnight Parking .....	24
Section 4.07 Reassignment of Leased Premises During Construction .....	24
Section 4.08 Surrender of the Premises .....	24
Section 4.09 Access .....	25
ARTICLE 5 – CALCULATIONS OF RENTS, FEES AND CHARGES .....	25
Section 5.01 Coordination Process.....	25
Section 5.02 Terminal Building Rental Rate .....	26
Section 5.03 Landing Fee Rate.....	26
Section 5.04 FIS Fee Rate .....	27
Section 5.05 Common Use Space Charges of Signatory Passenger Carrier .....	28
Section 5.06 Other Charges for Signatory Passenger Carrier .....	28
Section 5.07 Charges for Non-Signatory Passenger Carriers.....	28
Section 5.08 Charges for Non-Signatory Charter Carrier .....	29
Section 5.09 Passenger Facility Charge (PFC) .....	29
Section 5.10 Rate Adjustment .....	30
Section 5.11 Annual True-up .....	31
Section 5.12 Signatory Credit.....	32
Section 5.13 Monthly Activity Report .....	33
Section 5.14 Payment Provisions/Interest on Overdue Amounts.....	34
Section 5.15 Taxes .....	35
Section 5.16 Records of Airline.....	35
Section 5.17 Right of Set Off .....	35

ARTICLE 6 – SECURITY DEPOSIT .....	35
Section 6.01 Due Date, Type, Form and Amount of Surety .....	35
Section 6.02 Drawdowns by City .....	36
Section 6.03 Return/Surrender/Release of Surety by City .....	36
ARTICLE 7: INDENTURE OF TRUST .....	37
Section 7.01 Subordination to Indenture of Trust.....	37
Section 7.02 Flow of Funds .....	37
ARTICLE 8: MAINTENANCE AND OPERATION OF AIRPORT.....	37
Section 8.01 City’s Responsibilities .....	37
Section 8.02 Airlines Responsibilities .....	38
Section 8.03 City’s Right to Inspect and Make Repairs .....	39
Section 8.04 Alterations and Improvements .....	39
Section 8.05 Payment Bond .....	40
Section 8.06 Leasehold Improvements.....	40
Section 8.07 Debts, Liens, Mortgages .....	40
ARTICLE 9: DAMAGE OR DESTRUCTION OF PREMISES .....	41
Section 9.01 Damage or Destruction .....	41
ARTICLE 10: INDEMNIFICATION, INSURANCE AND RELEASE .....	41
Section 10.1 Indemnification .....	41
Section 10.2 Insurance .....	43
Section 10.3 Non-liability of City.....	46
ARTICLE 11: ASSIGNMENT AND SUBLETTING .....	46
Section 11.01 Merger, Assignment and Subletting.....	46
Section 11.02 Relinquishment of Space.....	46
Section 11.03 Bankruptcy.....	46
Section 11.04 Consent .....	47
ARTICLE 12: DEFAULTS .....	47
Section 12.01 Default.....	47
ARTICLE 13: TERMINATION .....	48
Section 13.01 Conditions of Leased Premises at Termination .....	48
Section 13.02 Events Permitting Termination by City.....	48
ARTICLE 14: GENERAL PROVISIONS.....	49
Section 14.01 Compliance with Law.....	49
Section 14.02 Notices.....	50
Section 14.03 Successors and Assigns Bound .....	51
Section 14.04 Governing Law, Venue and Attorney’s Fees .....	51
Section 14.05 Subordination to Agreements with U.S. Government .....	51
Section 14.06 Nonwaiver of Rights.....	51
Section 14.07 Federal Aviation Act, Section 308.....	51
Section 14.08 Severability .....	52
Section 14.09 Headings .....	52
Section 14.10 Bad Checks .....	52
Section 14.11 Assignment by City or Other Successor in Interest.....	52
Section 14.12 Authorization.....	52
Section 14.13 Removal of Disabled Aircraft .....	52
Section 14.14 Quiet Enjoyment .....	53
Section 14.15 Force Majeure .....	53

Section 14.16	Independent Contractor .....	53
Section 14.17	Partnership/Joint Venture .....	53
Section 14.18	Compliance with ADA and Other Handicap Access and Nondiscrimination .....	54
Section 14.19	Compliance with Environmental Laws .....	54
Section 14.20	Covenant Not to Grant More Favorable Terms.....	56
Section 14.21	Interpretation of Provisions .....	56
Section 14.22	Interpretation of Agreement.....	56
Section 14.23	Cumulative Remedies.....	56
Section 14.24	Non-Solicitation .....	56
Section 14.25	Precedence of Documents .....	57
Section 14.26	Entire Agreement.....	57
ARTICLE 15:	SIGNATURE .....	58



This Airport Use and Lease Agreement (Agreement) is made and entered into this <sup>4/13/2022</sup> day of April, 2022, by and between the City of Fresno, a municipal corporation, (City or Airport) and, Southwest Airlines, Co., a Texas Corporation admitted in good standing to do business in California, (Airline) and collectively referred to as the "Parties".

## RECITALS

**WHEREAS**, City is the owner and operator of Fresno Yosemite International Airport located in the City of Fresno, County of Fresno, State of California, (Airport); and

**WHEREAS**, Airline is engaged in the business of commercial air transportation of persons, property, cargo and mail as a scheduled air carrier and is certified or otherwise authorized by the United States Government to engage in such business; and

**WHEREAS**, Airline wishes to provide commercial air transportation at the Airport on a non-exclusive basis and in competition with other passenger carriers engaged in similar businesses and, desires to enter into this Agreement, negotiated in common with all similar incumbent passenger carriers for the use of the Airport and its facilities; and

**WHEREAS**, This Agreement shall supersede all previously executed agreements; and

**WHEREAS**, The City has the right to lease property at the Airport and to grant the use of the Airport to Airline for the operation of Airline's passenger carrier service.

## AGREEMENT

The Parties agree this Agreement is subject to the terms, covenants, conditions, agreements, warranties, and provisions herein contained and Airline expressly covenants and agrees, as a material part of the consideration for the Agreement, that Airline shall fully and faithfully comply with, keep, perform and/or observe each and every term, covenant, condition, agreement, warranty, and/or provision hereof to be complied with, kept performed, and/or observed by Airline.

## ARTICLE 1 - DEFINITIONS

### Section 1.01 Meanings and Construction.

Except as otherwise clearly indicated by the context, the words and phrases defined in this Section shall have the following meanings when used elsewhere in this Agreement.

Affiliate shall mean a passenger carrier that is designated by a Signatory Passenger Carrier on forms in **Exhibit J**, which is (i) controlled by, controlling, or under common control with a Signatory Passenger Carrier; or (ii) shares an International Air Transport Association (IATA) flight designator code with a Signatory Passenger Carrier at the Airport (code sharing partner); or (iii) otherwise operates under essentially the same trade name as a Signatory Passenger Carrier at the Airport or uses essentially the same livery as Airline at the Airport. A Passenger Carrier shall only be deemed an Affiliate of a Signatory Passenger Carrier during those times in which the Passenger Carrier is acting for and on behalf of the Signatory Passenger Carrier.

Agreement or Airport Use Agreement (AUA) shall mean this Airport Use and Lease Agreement.

Airfield Area shall mean those portions of the Airport, including the terminal apron and the cargo apron, provided for the landing, taking off, and taxiing of aircraft, including without limitation approach and turning zones, clear zones, avigation or other easements, runways, a fully integrated taxiway system, runway and taxiway lights, and other appurtenances related to the aeronautical use of the Airport, including any airfield property purchased for noise or other environmental mitigation purposes, all as shown on **Exhibit E**, as may be modified, renovated or enlarged.

Aircraft Parking Position shall mean the location where the aircraft is parked on the ramp.

Airfield Area Credit shall mean the sum of annual military use fees, fuel flowage fees, tower area rentals, government land rentals, and U.S. Forest Service landing fees.

Airfield Area Cost Center shall mean and refers to Air Operations Areas including runways, taxiways, perimeter fencing and approach protection areas.

Airline shall mean the Signatory Passenger Carrier, which is a party to this Agreement.

Airline Airfield Area Net Requirement shall mean annual costs, deposits, and coverage requirements allocable to the Airfield Area Cost Center and adjusted by the Airfield Area Credit and the Annual True-Up, as shown on **Exhibit F** and described in Article 5.

Airline FIS Net Requirement shall mean annual costs, deposits, and coverage requirements allocable to the FIS Facility Cost Center and adjusted by the Annual True-Up, as shown on **Exhibit G** and described in Article 5.

Airline Rates and Charges shall mean rates and charges established pursuant to Article 5.

Airline Terminal Building Net Requirement annual costs, deposits, and coverage requirements allocable to the Terminal Building Cost Center and adjusted by the Annual True-Up, as shown on **Exhibit D** and described in Article 5.

Airport shall mean the Fresno Yosemite International Airport (FAT), as it currently exists or hereafter may be modified.

Airport Rules for Airlines/Ground Handlers (Rules and Regulations) shall mean the manual provided by Director of Aviation or his appointed staff for operating an Airline at Airport. It is the lawful, reasonable, and impartial rules and regulations, including ordinances and operating directives, promulgated by the Director of Aviation or the City from time to time for the orderly operation of the Airport. City shall provide reasonable advance written notice of any changes to the Rules and Regulations.

Air Transportation Business shall mean the carriage by aircraft of persons or property as a common carrier for compensation or hire, or the carriage of cargo, freight or mail by aircraft in commerce, as defined in the Federal Aviation Act of 1958, as amended.

Amortization Charge shall mean, with respect to a capital project to be paid or financed with airport cash (as opposed to Bonds), an amount based on the useful life of the project and calculated using an interest rate of 3.45%. Amortization Charge shall be calculated

starting from the first full Fiscal Year after the DBO of the project. For projects put in service prior to July 1, 2022, the interest rate shall be zero percent.

Annual True-up shall mean the recalculation of Airline Rates and Charges of a Fiscal Year after the end of such Fiscal Year based on actual results pursuant to Article 5.

Bond(s) shall mean all bonds, notes, or other obligations issued by the City pursuant to the Indenture of Trust.

Capital Allowance shall mean an annual allowance for capital projects of four million dollars

(\$4,000,000). The Capital Allowance may be adjusted if the Agreement is extended beyond the initial five (5) year term.

City shall mean the City of Fresno California, a municipal corporation.

City Airports shall mean the airport known as the Fresno Yosemite International Airport, located within the City, and the airport known as the Fresno Chandler Executive Airport, located within the City, each as it now exists, including, without limitation, runways, taxiways, landing pads, aprons, beacon sites, obstruction lights, navigational and landing aids, control towers, facilities for storage of aircraft and for parking of automobiles, roadways, passenger and freight terminals, land, easements and rights in land for clear zone and approach purposes, maintenance hangars and related facilities and all equipment, buildings, grounds, facilities, utilities and structures owned, leased or operated in connection with or for the promotion or the accommodation of air commerce and air navigation and services in connection therewith, together with all additions, betterments, extensions, replacements, renewals and improvements thereto which may hereafter be undertaken, and any future airport or aviation facilities, or any interest therein, from time to time hereafter owned, operated or controlled in whole or in part by the City and determined by the City to be a part of the City Airports.

Collecting Carrier means an issuing carrier or other carrier collecting a PFC, whether or not such carrier issues the air travel ticket.

Common Use Facilities Policy and Procedures Manual (Common Use Policy) shall mean the policy and procedures manual provided by Director of Aviation, which describes the procedures lawful, reasonable, and impartial rules and regulations, including ordinances and operating directives, promulgated by the Director of Aviation or the City from time to time for the orderly operation of the Airport.

Common Use Formula shall mean the formula for apportionment of the total monthly rental for Common Use Space, net of Non-Signatory Charter Carrier Terminal Use Fee payments if any, among the Signatory and Non-Signatory Passenger Carriers using the Common Use Space on the basis of: (a) twenty percent (20%) of the total monthly rental apportioned evenly among all Signatory and Non-Signatory Passenger Carriers using such space for the month; and (b) the remaining eighty percent (80%) of the total monthly rental prorated among all Signatory and Non-Signatory Passenger Carriers using such space on the basis of the ratio of each airline's Enplaning Passengers at the Airport divided by the total number of Enplaning Passengers at the Airport of all Signatory and

Non-Signatory Passenger Carriers using such space for the month. FIS users are not subject to common use charges related to baggage claim area in the Terminal Building.

Common Use Space shall mean space leased by Airline in common with other Signatory and Non-Signatory Passenger Carriers in the Terminal Building, including ticket counter and queuing space, baggage makeup space, baggage claim space, TSA passenger and baggage screening space, holdroom space and other spaces as described in Article 4 and delineated on **Exhibit A**.

Common Use Ticket Counter Position shall mean the ticket counter position(s) designated by the City for the use by the Airline as assigned in accordance with the Common Use Facilities Policy and Procedures Manual.

Consumer Price Index For All Urban Consumers or CPI shall mean the Consumer Price Index for Urban Wage Earners and Clerical Workers by the Bureau of Labor Statistics, U.S. Department of Labor (all items, U.S. city average) from January 1 to December 31 during the last full calendar year prior to the scheduled rental adjustment date. CPI shall have a base year of 2019.

Cost Centers shall mean the areas (and functional activities associated with such areas) used in accounting to aggregate costs for the purposes of calculating Airline Rates and Charges, including Airfield Area, Terminal Building, and FIS Facility.

COVID-19 Federal Operating Grants shall mean the federal operating grant reimbursements received under the Coronavirus Aid, Relief, and Economic Security Act, the Coronavirus Response and Relief Supplemental Appropriations Act, the American Rescue Plan Act, and other federal regulations related to COVID-19.

Date of Beneficial Occupancy or DBO shall mean the date when a project or phased component of a project has been completed and the Director of Aviation determines that it is available for use by Passenger Carriers or Cargo Carriers.

Debt Service shall mean the sum of (a) Adjusted Debt Service and (b) other amounts, if any, to be paid into the Subordinated Indebtedness Funds, both as defined in the Indenture of Trust.

Director of Aviation shall mean the City's Director of Aviation, or the designee or other individual authorized to perform the duties of the Director of Aviation.

Effective Date shall mean the date indicated in Section 2.01.

Enplaned Passengers shall mean any passenger boarding an aircraft at the Terminal Building, including any such passenger that previously disembarked from another aircraft of the same or a different Signatory or Non-Signatory Passenger Carrier or Non-Signatory Charter Carrier or from the same aircraft previously operating under a different flight number. The term Enplaned Passenger shall exclude all Airline personnel who are working on the flight.

Environmental Laws shall mean all applicable federal, state, and local statutes, ordinances, regulations, rules, laws, permits, and orders relating to the generation, use,

storage, transportation, or disposal of Hazardous Materials, including, without limitation, the Clean Air Act, 42 U.S.C. §7401 *et seq.*; the Clean Water Act, 33 U.S.C. §1251 *et seq.*, as amended by the Water Quality Act of 1987; the Federal Insecticide, Fungicide, and Rodenticide Act, 7 U.S.C. §136 *et seq.*; the Marine Protection, Research, and Sanctuaries Act, 33 U.S.C. §1401 *et seq.*; the Noise Control Act, 42 U.S.C. §4901 *et seq.*; the Occupational Safety and Health Act, 29 U.S.C. §651 *et seq.*; the Resource Conservation and Recovery Act, 42 U.S.C. §6901 *et seq.*, as amended by the Hazardous and Solid Waste Amendments of 1984; the Safe Drinking Water Act, 42 U.S.C. §300f *et seq.*; the Comprehensive Environmental Response, Compensation and Liability Act (“CERCLA”), 42 U.S.C. §9601 *et seq.*, as amended by the Superfund Amendments and Reauthorization Act, the Emergency Planning and Community Right to Know Act, and the Radon Gas and Indoor Air Quality Research Act; the Hazardous Material Transportation Act, 49 U.S.C. §5101 *et seq.*; and the Toxic Substance Control Act, 15 U.S.C. §2601 *et seq.*; the Atomic Energy Act, 42 U.S.C. 2011*et seq.*; and the Nuclear Waste Policy Act of 1982, U.S.C. §1010 *et seq.*

Environmental Permits shall mean any and all permits, licenses, approvals, authorizations, consents, or registrations required by Environmental Laws, whether federal, state or local, which pertain to the production, use, treatment, generation, transportation, processing, handling, disposal, or storage of Hazardous Materials.

Event of Default shall mean an Event of Default as referred to in Article 7 and as defined in Section 9.01 of the Indenture of Trust.

Exclusive Use Space shall mean the areas within the Terminal Building, as depicted on **Exhibit B**, in which Airline has the exclusive right of use in accordance with this Agreement.

Federal Aviation Administration or FAA shall mean the Federal Aviation Administration or any successor agency thereto.

FIS Facility or FIS shall mean federal inspection services facilities as shown on **Exhibit A**, as may be modified, renovated and enlarged.

FIS Fee Rate shall mean the rate for each FIS User established pursuant to Section 5.04.

FIS Facility Cost Center shall mean and refers to FIS Facility and includes meeters and greeters area.

FIS Facility Project shall mean the renovation and expansion of the FIS Facilities, as depicted by the City in the 2019 Master Plan for the Airport.

FIS User(s) shall mean a passenger arriving on international flights using the FIS Facility at the Airport.

Fiscal Year or FY refers to the City's fiscal year and shall mean the twelve-month period commencing July 1 and extending through June 30 of the following calendar year, or such other fiscal year as the City may establish by ordinance.

Gate(s) shall mean each area from which passengers enplane or deplane aircraft, including but not limited to the associated hold room, common use computer system, and podium(s).

Hazardous Materials shall mean friable asbestos or asbestos-containing materials; polychlorinated biphenyls (PCBs); petroleum, or crude oil or any fraction thereof; natural gas, special nuclear material, and byproduct materials regulated under Environmental Laws, pesticides regulated under Environmental Laws, and any hazardous waste, toxic, or dangerous substance or related material, including any material defined as a hazardous substance, hazardous waste, toxic substance, pollutant or contaminant (or comparable term) under any Environmental Laws.

Indenture of Trust shall mean the Indenture of Trust dated June 15, 2000 by and between the City of Fresno and BNY Western Trust Company as Trustee, as amended and supplemented, relating to City of Fresno Airport Revenue Bonds.

Landed Weight shall mean the highest maximum gross certificated landing weight for the aircraft model operated at the Airport by carrier as listed in the manufacturer's Characteristics or Planning Manual. If the manufacturer's Characteristics or Planning Manual is not available, the FAA Type Certificate Data Sheet will be used. The Airport may annually review and update the highest maximum gross landing weight based on any changes to the Characteristics or Planning Manual, or the FAA Type Certificate Data Sheet, as applicable.

Landing Fee Rate shall mean any Landing Fee Rate per thousand pounds of Landed Weight as established pursuant to Section 5.03.

Leased Premises shall mean Common Use Space and Exclusive Use Space in the Terminal Building as defined in this Agreement and depicted in its exhibits.

Master Fee Schedule shall mean the annual schedule of fees published by the City.

Multi-User Flight Information Display System (MUFIDS) or Flight Information Display System (FIDS) shall mean a network of monitors and software applications that displays real-time flight information for the passengers.

Non-Signatory Cargo Carrier shall mean a cargo carrier using the Airport that is not a Signatory Cargo Carrier.

Non-Signatory Charter Carrier shall mean a passenger carrier using the Airport that offers either (a) non-scheduled services or (b) seasonal services that lasts less than twelve (12) consecutive months.

Non-Signatory Passenger Carrier shall mean a passenger carrier using the Airport to provide scheduled air service but is not a Signatory Passenger Carrier or a Non-Signatory Charter Carrier.

Non-Signatory Charter Carrier Terminal Use Fee shall mean the fees and charges in the Master Fee Schedule applicable to Non-Signatory Charter Carriers, which may be revised by the City from time to time.

Non-Signatory Terminal Common Use Fee shall mean the fee per Enplaned Passenger to be paid by Non-Signatory Passenger Carriers for the use of Terminal Building Common Use Space, calculated as the product of the total square footage of Common Use Space

and Terminal Building Rental Rate divided by Enplaned Passengers of all Passenger Carriers using the Terminal Building Common Use Space and multiplied by One Hundred and Twenty-five Percent (125%).

Notice shall mean a communication between the Parties to this Agreement performed in accordance with the requirements of Section 14.02.

Operating Expenses shall mean the reasonable and necessary costs of operating, maintaining and administering the City Airports, as defined in the Indenture of Trust.

Operating Reserve Fund shall mean Operating Reserve Fund as defined in the Indenture of Trust.

Other Buildings and Areas shall mean buildings and areas at the Airport that are not part of the Airfield Area, Terminal Building or FIS Facility.

Passenger Carriers shall include Signatory Passenger Carriers, Non-Signatory Passenger Carriers, and Non-Signatory Charter Carriers.

Passenger Facility Charge or PFC shall mean charges imposed by the City pursuant to 49 U.S.C. § 40117 and 14 C.F.R. Part 158, as amended or supplemented from time to time.

Preferential Use Positions shall mean means those Gates, Aircraft Parking Positions and Common Use Ticket Counter Position within the Terminal Building, as depicted on **Exhibit B**.

Rate Covenant shall mean Section 8.11 of the Indenture of Trust as hereafter may be amended.

Rentable Space shall mean the number of square feet of space in the Terminal Building that is rentable to tenants, excluding public space, FIS Facility space, space used by City or the City's contractor and other space used by federal agencies for which City receives no rent, as may be determined by the Director of Aviation.

Rents, Fees, and Charges shall mean for any Fiscal Year, all rents, fees, and charges payable by Airline pursuant to Article 5. The definition of Rents, Fees, and Charges excludes Passenger Facility Charge.

Rolling Debt Service Coverage shall go into effect at DBO, and shall amount to 25 percent (25%) of the Debt Service for the Fiscal Year being calculated less 25 percent (25%) of the Debt Service for the prior Fiscal Year, plus similar coverage requirement for the Subordinated Indebtedness if any.

Security Deposit shall mean an irrevocable letter of credit or another instrument acceptable to the City provided pursuant to Article 6.

Security Fee shall mean the fee imposed on each Enplaned Passenger by the City to recover security related expenses, pursuant to Section 5.06. A Consumer Price Index adjustment may be applied to the Security Fee if the Agreement is extended beyond the initial five (5) year term.

Signatory Cargo Carrier shall mean a carrier engaging in all-cargo air transportation at the Airport, which is certificated by the Secretary of the U.S. Department of Transportation under 49 U.S.C. § 41103, or 49 U.S.C. § 41302, and has executed a lease of cargo building space and preferential cargo ramp space directly from the City.

Signatory Credit shall mean fifty percent (50%) of the positive amount, if any, of Revenues less (a) Operating Expenses; (b) Debt Service; (c) required deposits, if any, to Operating Reserve Fund pursuant to the Indenture of Trust; and (d) Capital Allowance, calculated after Annual True-up.

Signatory Passenger Carrier shall mean a passenger carrier that has executed an Airport Use Agreement (AUA) and is engaging in regularly scheduled passenger service related to air transportation at the Airport, which is certificated by the Secretary of the U.S. Department of Transportation under 49 U.S.C § 41102, or 49 U.S.C § 41302.

Terminal Building shall mean the terminal complex area of the Airport as shown in **Exhibit C**, as may be modified, renovated or enlarged.

Terminal Building Cost Center shall mean and refers to Terminal/Concourse Building, hotel and autos service station. Also includes landscaping along terminal roadways.

Terminal Building Net Requirement shall mean annual costs, deposits, and coverage requirements allocable to the Terminal Building and adjusted by Security Fees, pursuant to Section 5.02.

Terminal Building Rental Rate shall mean the annual rental rate per square foot for space in the Terminal Building, calculated by dividing the Terminal Building Net Requirement by Useable Space, as shown in **Exhibit D** and described in Section 5.02.

Transportation Security Administration or TSA shall mean the Transportation Security Administration created under the Aviation and Transportation Security Act of 2001, as amended, or any successor agency thereto.

United States Customs and Border Protection or CBP shall mean the U.S. Customs and Border Protection law enforcement agency and is part of the United States Department of Homeland Security.

Usable Space shall mean space in the Terminal Building determined by the City that is either rentable by tenants or usable for public circulation pre- or post-security, which may be amended by City from time to time to reflect additions to or deletions of space, or other structural changes within the Terminal Building.

## Section 1.02 Interpretation

- A. References in the text of this Agreement to articles, sections, paragraphs, or exhibits pertain to articles, sections, paragraphs, or exhibits of this Agreement, unless otherwise specified.



- B. The terms “hereby,” “herein,” “hereof,” “hereto,” “hereunder,” and any similar terms used in this Agreement refer to this Agreement.
- C. Words importing persons shall include firms, associations, partnerships, trusts, corporations, and other legal entities, including public bodies, as well as natural persons.
- D. Any headings preceding the text of the articles and sections of this Agreement, and any table of contents or marginal notes appended to copies hereof, shall be solely for convenience of reference and shall not constitute a part of this Agreement, nor shall they affect its meaning, construction, or effect.
- E. Words importing the singular shall include the plural and vice versa. Words of any gender shall be deemed to include correlative words of the other gender.
- F. The term “including” shall be construed to mean “including without limitation,” unless otherwise expressly indicated.
- G. All references to number of days shall mean calendar days.
- H. Words used in the present tense include the future.

## **ARTICLE 2 - TERM OF THE AGREEMENT**

### Section 2.01 Term

The term of this Agreement shall commence on July 1, 2022, and shall expire at midnight on June 30, 2027, unless sooner terminated pursuant to the provisions hereof.

### Section 2.02 Condition Under Which the Agreement Becomes Effective

The Agreement becomes effective if executed by Airlines accounting for at least 75% of Signatory Passenger Carriers’ and Signatory Cargo Carriers’ total Landed Weight from May 2021 – August 2021.

### Section 2.03 Options to Extend

- A. First Option: The first option to extend the term of this Agreement will be for an additional period of five (5) years, thereby ending June 30, 2032, upon the mutual agreement, in writing by side letter, of the City and the Signatory Passenger Carriers. The Signatory Passenger Carriers’ and Signatory Cargo Carriers accounting for a combined total Landed Weight of no less than 67% for the calendar year 2025, must agree to the option, and written Notice must be given to the City prior to October 1, 2026. Upon receipt of this Notice, the City must notify the Signatory Passenger Carriers of its mutual agreement to extend the term of this Agreement prior to January 1, 2027. Signatory Passenger Carriers will be allowed to evaluate and adjust their space needs following the initial five (5) year term, and by no later than April 30, 2027, provide the City their adjusted space needs, if any.

- B. Second Option: The second option to extend the term of this Agreement will be for an additional period of five (5) years, thereby ending June 30, 2037, upon the mutual agreement, in writing by side letter, of the City and the Signatory Passenger Carriers. The Signatory Passenger Carriers' and Signatory Cargo Carriers accounting for a combined total Landed Weight 67% for the calendar year 2030, must agree to the option and written Notice must be given to the City prior to October 1, 2031. Upon receipt of this Notice, the City must notify the Signatory Passenger Carriers of its mutual agreement to extend the term of this Agreement prior to January 1, 2032. Signatory Passenger Carriers will be allowed to evaluate and adjust their space needs following the extended five (5) year term, and by no later than April 30, 2032, provide the City their adjusted space needs, if any.

Section 2.04 Holding Over

Holding over by Airline after the expiration or earlier termination of the Agreement with or without the consent of City shall be a tenancy from month-to-month only, terminable on thirty (30) days' written notice; provided, however, that if Airline shall be in default of this Agreement beyond all notice and cure periods at the commencement of the holdover, then the Airline shall not be entitled to Signatory Passenger Carriers' fees and charges during said month-to-month tenancy and shall pay the non-signatory fees and charges as established by City and further provided that except as otherwise specifically provided within this Article, any such holding over shall be subject to all the other terms, covenants, conditions, restrictions reservations, prohibitions, warranties, agreements and provision of this Agreement applicable to a month-to-month tenancy.

**ARTICLE 3 - AIRLINE RIGHTS, PRIVILEGES, AND LIMITATIONS**

Section 3.01 Use of Airport

Subject to the terms of this Agreement, Airline shall have the right to conduct its Air Transportation Business at the Airport, directly or through its Affiliate(s), and to perform all operations and functions that are incidental or necessary to the conduct of such business at the Airport. Each Affiliate shall have the same rights as Airline with respect to its use and occupancy of the Airport. Nothing in this Article shall be construed as authorizing Airline to conduct any business separate and apart from the conduct of its Air Transportation Business at the Airport. Any rights not specifically granted to Airline for its use of and operations at the Airport pursuant to this Agreement are hereby reserved for and to the City.

- A. Use of Common Facilities at the Airport. Airline, its employees, passengers, guests, patrons, agents, independent contractors, and invitees shall have the right to the use, in common with other duly authorized users, of those portions of the Airport and appurtenances, together with all facilities, improvements, equipment, and services that have been or may hereafter be provided for common or joint use by the City at or in conjunction with the Airport.

- B. Use in Common of Terminal Building. Airline shall have the right to use, in common with, and subject to the rights of others so authorized, the public areas and public facilities of the Terminal Building.
- C. Use in Common of Airfield Area. Airline shall have the right to use the Airfield Area, in common with others so authorized, to land, takeoff, fly over, taxi, tow, park, and condition Airline's aircraft. Airline shall have the right to park, service, deice, load, unload, and maintain Airline's aircraft and support equipment in areas designated by the City, subject to the availability of space. Airline shall not knowingly permit, without the consent of the City, the use of the Airfield Area or any portion thereof by any aircraft operated or controlled by Airline that exceeds the design strength or capability of such area as described in the then-current FAA-approved Airport Layout Plan (ALP) or other engineering evaluations performed subsequent to the then-current ALP, including the then-current Airport Certification Manual, a copy of which shall be provided, upon request, by the City to Airline.
- D. Airline Operations. Airline shall have the right to handle reservations, sell tickets; document shipments; and load and unload (i) persons through passenger loading bridges affixed to the terminal structure, (ii) property, (iii) cargo, and (iv) mail, including interlining with other airlines. Airline shall also be permitted to engage in the following activities at the Airport:
1. The operation of an air transportation system by aircraft for the carriage of persons, property, and mail, for compensation or hire, on a reasonable and not unjustly discriminatory basis, including all activities reasonably necessary to such operation including advertising and marketing associated with services offered by Airline and/or its partners.
  2. The landing, taking off, flying over, taxiing, pushing, towing, loading, unloading, fueling, repairing, maintaining, conditioning, servicing, parking, storing, and testing of aircraft or other equipment of or operated by Airline, or other certificated air transportation company with which City has an applicable agreement, including the right to provide or handle all or part of the operations or services of such other company, all of which are subject to this Agreement.
  3. The sale of tickets, documentation of shipments, handling of reservations, and the loading and unloading of persons, property, cargo, and mail at the Airport by such motor vehicles or other means of conveyance as Airline may desire to use in the operation of its air transportation system. However, City reserves the right to require any ground transportation commercial carrier (including Airline) regularly transporting persons to and from the Airport to first secure and thereafter hold a valid lease, license, permit, or other agreement with City for the right to carry persons to and from the Airport and shall pay City such rentals, fees, charges, and/or percentages of the

fares of such ground transportation commercial carrier for such right as City may set.

4. The training of persons and testing of aircraft and other equipment at the Airport, such training and testing to be limited to that incidental to Airline's Air Transportation Business.
5. Subject to this Agreement, the purchase of Airline's requirements of personal property or services, including fuel, lubricants, food, beverage, and other passenger supplies, and any other materials and supplies used by Airline from any person or company of Airline's choice for services to be performed for Airline that are incidental to the operation of Airline's Air Transportation Business. Nothing herein shall restrict City from levying a nondiscriminatory concession fee on any person or company for conducting non-air transportation business at the Airport.
6. The sale, disposal, and exchange of Airline's aircraft, engines, accessories, fuel, oil, lubricants, other equipment, and materials or supplies to other Air Transportation companies. Such right shall not be construed as authorizing the conduct of a separate regular business by Airline, but as permitting Airline to perform only those functions that are related to the operation of its Air Transportation Business.
7. The servicing by Airline, or by its suppliers of materials or its furnishers of services, or aircraft and other equipment operated by Airline with minor maintenance or other materials or supplies, at its assigned Aircraft Parking Positions or other Aircraft Parking Positions designated by City. City reserves the right at any time to designate other locations reasonably accessible from the Terminal Building for performance of aircraft maintenance and service activities if City believes that such activities would interfere with aircraft operations of other airlines subject to availability of space and to such rules and regulations the City may establish.
8. Airline or its ground handling service provider shall be required to supply all ground service equipment necessary to service their scheduled airline operations. If any Airline or ground handling service provider has an agreement to use another company's equipment, a copy of such written agreement shall be provided to the City upon its execution.
9. The installation and operation, at Airline's sole cost and expenses, of identifying signs and graphics on the Airline's Exclusive Use Space subject to prior written approval of City, (not to be unreasonably withheld or delayed) provided that such signs shall be: (1) substantially uniform in size, type, and location with those of other airlines; (2) consistent with City's graphics standards as established from time to time by the City; and (3) in compliance with all local laws, ordinances and rules and regulations.

10. The installation, maintenance, and operation, at no cost to City, of such radio, communication, meteorological, and aerial navigation equipment and facilities at suitable locations on the Airport. The location of such equipment and facilities, method of installation, and type of equipment shall be subject to the prior written approval of City, and shall conform with all applicable federal, state, and local requirements. Airline is required to input and maintain flight information in the Multi-User Flight Information Display System (MUFIDS) installed by City to display flight information. Airline may use its own FIDS in its Leased Premises subject to the prior written consent of Director of Aviation and subject to such reasonable conditions as Director of Aviation may require.
11. In order to maximize the utilization of holdroom check-in podiums, holdroom areas and other passenger facilities in the Terminal Building, City reserves the right, but is not hereby obligated, to install and require Airline to use common use gate information display technology and/or equipment (not to include Airlines customer service automation equipment). Until such time as City installs such equipment, Airline may install, at Airline's cost, identifying signs and/or gate information displays ("signage") at the podium in the holdroom of the Gate(s) assigned to Airline and/or other locations approved by City. City shall reasonably establish standards and/or guidelines regarding the dimensions, materials, and content of such signs, and the method of attaching the sign to the designated location. Any signage installed by Airline shall be at the risk of Airline. In the event that Airline shall be no longer assigned the use of the Gate(s), then, upon the request of City, Airline shall promptly remove such signage at Airline's expense.
12. The provision of baggage porter skycap service, curbside airline baggage check-in services in the public areas of the Terminal Building. Airline may arrange with other airline to provide such services or may provide such services on its own behalf. Airline shall notify the City in writing as to what company is providing such services at the Airport. City reserves the right to require third party companies to enter into a lease or permit with the City for such services provided to Airline.
13. The rights and privileges granted Airline under this Agreement with respect to the performance of ground services and activities in connection with its Air Transportation Business at the Airport may be exercised by Airline only for and on behalf of Airline for its regularly scheduled or unscheduled service and that of its affiliates, subsidiaries, and code share partners identified in this Agreement. Airline may, subject to the prior written approval by City, perform ground services for any Air Transportation Business using the Airport provided said company has executed an operating agreement or permit with the City and further provided that said company agrees to report its activity or arranges to have Airline report its activity in the manner described in this Agreement.

14. It is understood and agreed that City reserves the right to charge and to collect reasonable fees or commissions for in-flight catering, vending, ground transportation, ground support services (excluding deicing services) for other Air Transportation Business(es), and other services or facilities provided by or for Airline in competition with concessionaires and operators operating under an agreement with City. The City's right to charge and collect fees or commissions from Airline and/or other Air Transportation Business(es) for such services or facilities shall not apply to Air Transportation Business serviced by Airline that are code share partners, subsidiaries, or affiliate airlines. The City's right to charge and collect a reasonable fee or commission shall be subject to a written and signed amendment by both Parties to this Agreement.
15. Airlines are responsible for registering all ground service equipment (GSE) owned or operated by Airline, with the City. While such equipment is in service at Airport, Airline is responsible for keeping it in working condition on the airfield and parked in the properly marked areas. In addition to this paragraph:
  - a. No unused or broken GSE equipment shall be left unattended in aircraft parking areas; and
  - b. No GSE equipment shall be parked in between aircraft parking spots.
16. Airline and its ground service provider operating on the Airline's behalf shall follow all Rules and Regulations as set forth by the City.

### Section 3.02 Employee Parking Facilities

Airline employees working at the Terminal Building shall have the right to the use of vehicular parking facilities in common with other employees. Such facilities shall be located in an area designated by City. City reserves the right to assess a reasonable charge to recover the costs of providing such space to such Airline employees, in common with other Airport/tenant employees, for such parking facilities.

### Section 3.03 Limitation on Use by Airline

In connection with the exercise of its rights under this Agreement, Airline:

- A. Shall not do or permit to be done anything at or about the Airport that may interfere with the use, operation, or maintenance of the Airport, including but not limited to, the effectiveness or accessibility of the water system, drainage and sewage system, fire protection system, sprinkler system, alarm system, fire hydrants and hoses, heating or ventilation system, air conditioning system, electrical system, natural gas, security system, communications, or other Airport systems installed or located on or within the Leased Premises or the Airport.

- B. Shall not do or permit to be done anything, either by act or failure to act, that shall cause the cancellation or violation of the provisions, or any part thereof, of any policy of insurance for the Airport, or that shall cause a hazardous condition so as to increase the risks normally attendant upon operations permitted by this Agreement. If Airline shall do or permit to be done any act not permitted under this Agreement, or fail to do any act required under this Agreement, which act or failure, in and of itself, causes an increase in City's insurance premiums, Airline shall immediately remedy such actions and/or pay the increase in premiums.
- C. Shall not dispose of or permit any employee, agent or contractor of Airline to dispose of any waste material, including but not limited to deicing materials, toxic waste, hazardous substance, hazardous waste, and Hazardous Materials (including hazardous materials as defined by federal and State of California regulations) except in accordance with controlling laws.
- D. Shall not keep or store any Hazardous Materials such as flammable liquids and solids, corrosive liquids, compressed gases, or magnetized or radioactive materials on the Airport except when all the following conditions are met: (1) such Hazardous Materials are stored in accordance with applicable standards established by National Fire Protection Association, any liquids having a flash point of less than one hundred degrees (100°) Fahrenheit shall be kept and stored as specified by NFPA #30; (2) said Hazardous Materials are under the control and care of designated and properly trained Airline personnel; (3) said Hazardous Materials are packaged, handled and stored in compliance with applicable Environmental Law including but not limited to: U.S. Department of Transportation, Environmental Protection Agency, and other applicable regulations for transport, pre-transport and storage of hazardous articles and materials; and (4) said materials shall be only stored in such storage areas as are designated and approved by Director of Aviation.
- E. Shall not install fuel storage tanks and pumping facilities for use in fueling any aircraft at the Airport without prior written approval of City. The granting of the right to store aviation fuels shall be subject to the execution of a separate agreement between Airline and City.
- F. Shall not maintain or operate in the Terminal Building or elsewhere at the Airport a cafeteria, restaurant, bar or cocktail lounge for the purpose of selling or dispensing food or beverages to the public or passengers; nor shall Airline in any manner otherwise provide for the sale or dispensing of food and beverages at the Airport except that the Airline may provide vending machines solely for the sale of hot and cold beverages, food and confections to Airline employees in areas not accessible to the general public. Airline may dispense snacks, drinks, and/or in-flight meals at the Gate to only those persons traveling on such flight. Airline may, by separate agreement with the City and to the extent it does not conflict with any terminal concession agreements, engage in the provision or sale of food or beverages at any Airline clubroom or similar private facility at the Airport. These provisions shall not apply to snacks or drinks provided to passengers by the Airline

due to irregular operations or long delay periods that are 60 minutes or more in duration.

- G. Agrees to comply with the FAA-approved Master Security Plan as amended from time to time for the Airport. Any fines and/or penalties levied against the City for security violations at the Airport caused by Airline or any of its employees, agents, or suppliers while under its control, shall be due and payable by Airline.
- I. Shall not install any coin-operated or card operated machine(s) or device(s), except for (1) machines for the sale of Airline's tickets or issuance of boarding passes located on Airline's Leased Premises or other areas approved in writing by City, or (2) beverage or snack machines, except as provided in this Agreement.

#### Section 3.04 Airport Use Summary

- A. Airline shall file an Airport Use Summary ("Summary") with the City within 15 days of the date hereof. City shall provide Airline with Summary report form requesting information specified below in regard to Airline's operation at the Airport. Airline shall maintain a current Summary on file with the City, and, if requested, by City, shall promptly confirm that the Summary then on file is accurate.
- B. Accordingly, the Summary shall provide the following:
  - 1. Names, addresses, and telephone numbers of Airline officials responsible for station operations, flight operations, properties, and facilities.
  - 2. The current and proposed schedules of Airline's flight activity at the Airport. The Airline shall use its commercially reasonable efforts to notify the City of schedule changes or the addition of flights at the Airport prior to or no later than when the public announcement thereof is made.
  - 3. When requested by the City, or when changes are planned by the Airline, the description of Airline's fleet and identification of the class of Airline's aircraft that will serve the Airport. Airline shall provide reasonable notice of the introduction of an aircraft that is not being operated by Airline at the Airport on the date of this Agreement.
  - 4. The identification of Airline's anticipated facilities requirements at the Airport.
  - 5. The Airline's aircraft recovery plan for disabled aircraft.
  - 6. The Airline's written plan for how it plans to handle all unscheduled aircraft operations.

#### Section 3.05 Airport Security



- A. Airline shall not do or permit its agents, employees, and its contractors or suppliers, while such contractors or suppliers are providing services to Airline, to do anything at the Airport that would be in conflict with or violate the requirements of any federal, state, or local law, regulation or security directive regarding airport security, as they may be amended from time to time, or the Airport's security program.
- B. Airline shall be responsible for obtaining and coordinating any security badging, vehicle decals, and/or any other actions required to ensure that Airline's agents, employees, contractors, or suppliers are in compliance with the City's approved security plan, and any federal regulation and security directive regarding airport security, as they may be amended from time to time. Airline shall be responsible for all costs associated with obtaining such badge and/or access privileges.

Section 3.06 Reassignment, Reallocation, Redesignation, Relocation and/or Recapture of Leased Premises

City may reassign, reallocate, re-designate and/or relocate Airline's Leased Premises as City, in its reasonable discretion, determines is necessary, after sixty (60 days) written notice to the Airline, under the operational needs of the Airport. The reasonable costs of any such reassignment, re-designation, reallocation or relocation shall be paid by the City.

**ARTICLE 4 - PREMISES**

Section 4.01 General

The City intends to maximize the utilization and flexibility of current Airport facilities to meet changing air service demands.

Section 4.02 Leased Premises

- A. Common Use Space: The City hereby leases to Airline, subject to the provisions of this Agreement, the Common Use Space as shown on **Exhibit A**. Airline accepts the Common Use Space in "As Is" condition, with no warranties or representations, expressed or implied, oral or written, made by the City or any of its agents or representatives; provided, however, that this Subsection 4.02A shall in no way diminish the City's obligations as otherwise provided for in this Agreement.
- B. Exclusive Use Space: The City hereby leases to Airline, subject to the provisions of this Agreement, the Exclusive Use Space as shown on **Exhibit B**. Airline accepts the Exclusive Use Space in "As Is" condition, with no warranties or representations, expressed or implied, oral or written, made by the City or any of its agents or representatives; provided, however, that this Subsection 4.02B shall in no way diminish the City's obligations as otherwise provided for in this Agreement.

1. City and Airline may, from time to time by mutual agreement, add to or delete space from the Leased Premises. Any such addition or deletion shall be subject to the rates and charges set forth in Article 5 hereof. In the event of any such addition or deletion, **Exhibits A and B** will be revised to reflect the resulting changes in Airline Leased Premises and signed by both Parties.
- C. City shall advise Airline, in writing, if and when the Airline is found to be operating in space other than Exclusive Use Space or Common Use Space and such space is not displayed on **Exhibits A or B**. The Airline shall upon receipt of Director of Aviation's written Notice promptly (i.e., within seventy-two (72) hours) cease its use of any and all space not leased to the Airline. In the event Airline does not immediately cease its use of such space, the City shall immediately bill the Airline for the additional space at non-signatory airline rates and, at its option, may require the Airline to vacate the space within 30 days or execute an amendment to its lease for such additional space. In the event of an amendment, **Exhibits A or B** shall be immediately revised to reflect the added space provided that additional space is not already leased to another tenant of the Airport. A copy of such revised **Exhibits A or B** shall be filed on record with the City and, upon such filing, shall automatically become a part of this Agreement.
- D. All space added to Airline Leased Premises, pursuant to Subsection 4.02(B) and/or Subsection 4.02(C), will become Leased Premises and will be subject to all the terms, conditions, and other provisions of this Agreement and Airline shall pay to City all rentals, fees and charges applicable to such additional premises in accordance with the terms of this Agreement.
- E. Airline agrees that City, at its option and upon ninety (90) days written Notice to Airline, may recapture the Airline's Leased Premises if said Leased Premises are required by City to implement any capital improvement projects. In such event, City agrees to provide Airline with comparable facilities, which shall be substituted for Airline's Leased Premises in accordance with Subsections 4.02(B) and 4.02(C). City shall reimburse Airline for any costs incurred by Airline arising from City's exercise of the right set forth in this Subsection 4.02(E).

Section 4.03 Aircraft Parking Areas:

Airline shall have a priority in using its Preferential Use Position as follows:

- A. Airline's right to its Preferential Use Position, as depicted in **Exhibit B-2**, shall be subject to requirements of the Common Use Policy, Rules and Regulations, Safety Management Systems and all Rules and Regulations as modified from time to time by the City provided that such the Common Use Policy, Rules and Regulations, Safety Management Systems shall not contravene the Airline priority of use for its "operations as scheduled".

- B. All Gates shall remain as Common Use Space as defined in and as further explained in the Common Use Policy provided that such the Common Use Space designation shall not contravene the Airlines rights of its Preferential Use Position for its “operations as scheduled”.

Section 4.04 Use of Loading Bridges

- A. Any loading bridges financed and maintained by City shall be made available to all airlines serving the Airport on a Common Use basis unless assigned for Preferential Use Position.
- B. The use of City-owned loading bridges shall be subject to the following terms and conditions:
  - 1. The bridges shall be operated only by employees or agents of Airline, but no such employees or agents shall be permitted to operate the bridges until they have satisfactorily completed a course of instruction conducted by City or City’s designee in the proper use and operation of the bridges, and have received a certificate or written notice from City or City’s designee qualifying them to operate the bridges.
  - 2. City and Airline each shall be solely responsible for any and all damages, claims, or injuries which may be caused by the negligent use of the bridges by their respective employees, agents, or servants, and each shall indemnify, defend and hold harmless the other and their respective officers, agents, and employees from any and all demands, losses, liabilities, or judgments and all claims of every kind and character, together with costs and expenses incident thereto, arising from or as a result of negligent acts or omissions thereof in connection with or arising from use of the loading bridges, provided that City’s liability shall not exceed the lesser of proceeds payable from its self-insurance retention or \$1,000,000. Each party shall notify the other, in writing, of any claims, damages, or injuries promptly after discovery of same by the party charged with giving notice.
  - 3. Airline shall be solely responsible for any damage to bridges caused by the action of its employees or agents.
  - 4. City, during the term of this Agreement, shall maintain and keep in good repair the loading bridges.

Section 4.05 Accommodation in City-Controlled Facilities

The City may retain under its exclusive control and possession certain facilities in the Terminal Building, including, initially, the facilities described and shown on **Exhibit A**. It is the intent of the City to use, at its discretion, any of the City-controlled facilities to accommodate: (i) airlines not requiring permanent facilities or airlines requiring temporary accommodation pending allocation of permanent facilities, and (ii) the needs

of Signatory Passenger Carriers and Non-Signatory Passenger Carriers. Upon Airline's request, the City may grant to Airline the right to use, in common with other airlines, designated City- controlled facilities subject to Airline's payment of applicable fees.

Section 4.06 Aircraft Overnight Parking

Airline is required to follow all requirements as defined in the Rules and Regulations and Common Use Policy.

Section 4.07 Reassignment of Leased Premises During Construction

During the term of this Agreement, City may initiate a terminal area construction project, which expands or modifies or impacts the Airline's Leased Premises including leasehold dimensions or location of Common Use Space. Before undertaking such construction project, Director of Aviation shall consult with and consider any suggestions of Airline at the planning states of the construction project, but the approval of Airline shall not be required. Upon completion of the construction project, Director of Aviation shall issue revised exhibits of Airline's Leased Premises, and such exhibits shall revise the basis for determining the amount of Leased Premises rentals, fees and charges payable by Airline.

In the event of a terminal area construction project it may be necessary for City to temporarily reassign Leased Premises or Aircraft Parking Positions during construction after reasonable written notice is provided to Airline. During the construction period, Airline shall pay appropriate charges only for those areas designated and utilized for Airline use. As reasonably agreed to by City, Airline costs for being relocated to temporary Leased Premises and for being returned to its permanent Leased Premised shall be paid by the City. City may, at its sole discretion, include such relocation costs as part of the construction project costs or pay such relocation costs from the Airports Surplus Fund, as defined in the Indenture of Trust.

Section 4.08 Surrender of the Premises

- A. Airline covenants and agrees that on expiration of the term of this Agreement, or on earlier termination as hereinafter provided, or on reassignment as heretofore provided, Airline will peaceably surrender possession of the Leased Premises/portions thereof in good condition, space should be returned to the City in the condition it was given upon first use of occupancy by the Airline, reasonable wear and tear excepted. City shall have the right to take possession thereof. City shall not be required to give notice to quit possession at the expiration date of the term of this Agreement except to any extent required by law.
- B. Airline shall have the right, on expiration or early termination of this Agreement and within thirty (30) calendar days thereafter, to remove or dispose of all trade fixtures and equipment and other personal property installed or placed by Airline at its expenses, in, on, or about the Airport, subject to any valid lien that City may have thereon for unpaid rents or fees. Such lien shall not apply to aircraft or aircraft

parts. Airline agrees to reimburse City for any net costs incurred by City if City elects to remove or dispose of Airline's property after such thirty (30) day period.

- C. Ownership of any and all property not removed by Airline within the said thirty (30) day period shall, at the option of City, vest in City.

Section 4.09 Access

- A. Subject to the provisions hereof and such restrictions as City may impose with respect to Airline's use of the Leased Premises pursuant hereto, City hereby grants to Airline, its agents, suppliers, employees, contractors, passengers, guests, and invitees, the right and privilege of free and unrestricted access, ingress, and egress to the Leased Premises and to public areas and public facilities of the Terminal Building.
- B. The ingress and egress provided for in Section 4.09(A) shall not be used, enjoyed, or extended to any person engaging in any activity or performing any act or furnishing any service for or on behalf of Airline that Airline is not authorized to engage in or perform under the provisions hereof unless expressly authorized in writing by City.
- C. City shall have the right at any time to close, relocate, reconstruct, change, alter, or modify any such means of access provided for Airline's use pursuant to this Agreement or otherwise, either temporarily or permanently, provided that reasonable notice to Airline and a reasonably convenient and comparable means of access, ingress, and egress shall exist or be provided in lieu thereof. City shall suffer no liability by reason thereof and such action shall in no way alter or affect any of Airline's obligations under this Agreement.

**ARTICLE 5 – CALCULATIONS OF RENTS, FEES AND CHARGES**

Section 5.01 Coordination Process

Effective July 1, 2022, and for each Fiscal Year thereafter for the term of this Agreement, Airline Rates and Charges shall be calculated based on the principles and procedures set forth in this Article. The methodology for the calculation of Airline Rates and Charges described in this Article is illustrated in **Exhibit D, Exhibit F, and Exhibit G.**

- A. On or about February 15 of each year, the City shall provide Airline's properties representative with a calculation of the Signatory Credit, as illustrated in **Exhibit H.**
- B. On or about April 1 of each year, the Signatory and Non-Signatory Passenger Carriers, including Airline, shall provide the City with an estimate of their Landed Weights of all aircraft expected to be landed at the Airport during the ensuing Fiscal

Year. Airline also shall make best efforts to provide the City with a similar estimate for each one of its Affiliates.

- C. On or about June 1 of each year, the City shall provide Airline's properties representative with (1) a preliminary calculation of Airline Rates and Charges; (2) budgeted operating expenses for the ensuing Fiscal Year; and (3) budgeted capital projects.
- D. Taking into account the Airline's consultation comments, and changes in circumstances or assumptions, if any, the City shall prepare a final calculation of Airline Rates and Charges for the ensuing Fiscal Year, and will make best efforts to provide a copy to Airline no later than the last business day of the month preceding the start of the new Fiscal Year.

Section 5.02 Terminal Building Rental Rate

- A. Terminal Building Rental Rate shall be calculated by using the following amounts allocable to the Terminal Building Cost Center:
  - 1. Debt Service (net of PFC revenues applied to eligible debt service, if any); plus
  - 2. Rolling Debt Service Coverage; plus
  - 3. Amortization Charges; plus
  - 4. Operating Expenses; plus
  - 5. Required deposit to the Operating Reserve Fund, if any; minus
  - 6. Terminal Building Credit; equals
  - 7. Terminal Building Net Requirement, divided by
  - 8. Usable Space, equal
  - 9. Terminal Building Rental Rate before adjustment, plus or minus
  - 10. Adjustments due to Annual True-up, equal
  - 11. Terminal Building Rental Rate, multiplied by
  - 12. The Leased Premises of Passenger Carriers, equal
  - 13. Airline Terminal Building Net Requirement
- B. Terminal Building Credit is made up of the following annual amounts:
  - 1. Security Fee
  - 2. COVID-19 Federal Operating Grants
  - 3. Other federal operating grant reimbursements

Section 5.03 Landing Fee Rate

- A. Landing Fee Rate shall be calculated by using the following amounts allocable to the Airfield Area Cost Center:
  - 1. Debt Service (net of PFC revenues applied to eligible debt service, if any); plus
  - 2. Rolling Debt Service Coverage; plus

3. Amortization Charges; plus
4. Operating Expenses; plus
5. Required deposit to the Operating Reserve Fund, if any; minus
6. Airfield Area Credit; plus or minus
7. Result of Annual True-up of the applicable prior Fiscal Year; equals
8. Airline Airfield Area Net Requirements, divided by
9. Landed Weight of Passenger Carriers and Cargo Carriers, equals
10. Landing Fee Rate

B. The Airfield Area Credit is made up of the following annual amounts:

1. Military use fees;
2. Fuel flowage fees;
3. Tower area rentals;
4. Government land rentals;
5. U.S. Forest Service landing fees;
6. COVID-19 Federal Operating Grants

C. Activities in Section 5.03, 5.04, 5.05, 5.06, 5.09, 5.10 and 5.11 shall include the activities of each Signatory Passenger Carrier's Affiliates.

Section 5.04 FIS Fee Rate

A. FIS Fee Rate shall be calculated by adding and subtracting the following amounts allocable to the FIS Facility Cost Center, as listed below:

1. Debt Service (net of PFC revenues applied to eligible debt service, if any); plus
2. Rolling Debt Service Coverage; plus
3. Amortization Charges; plus
4. Operating Expenses; plus
5. Required deposit to the Operating Reserve Fund, if any; minus
6. Applicable credits including COVID-19 Federal Operating Grants; plus or minus
7. Result of Annual True-up of the applicable prior Fiscal Year; equals
8. Airline FIS Net Requirements, divided by
9. FIS Users, equals
10. FIS Fee Rate

A. The maximum FIS Fee Rate shall not exceed \$12.00 per FIS User through the DBO of the FIS Facility Project, or \$15.00 thereafter for the remaining term of this Agreement.

B. The City will use its best efforts to obtain the Port of Entry status, which would transfer the staffing of the FIS Facility to the CBP, resulting in a decline of the calculated FIS Fee Rate.

Section 5.05 Common Use Space Charges of Signatory Passenger Carrier

The City shall calculate the Common Use Space charges by multiplying the total square footage of Common Use Space by Terminal Building Rental Rate net of applicable Non-Signatory Terminal Use Fee payments, if any, and allocate the net charges based on the Common Use Formula on a monthly basis.

Section 5.06 Other Charges for Signatory Passenger Carrier

- A. The City shall continue to implement the Security Fee rate at One Dollar (\$1.00) per Enplaned Passenger during the initial term of the Agreement.
  - 1. If the first and second option to extend are approved by the Signatory Passenger Airlines, the City may, at its discretion adjust the Security Fee rate, based on changes in the CPI. Any adjustment shall occur prior to the end of each term period.
- B. The City reserves the right to establish, modify, or assess from time to time, and Airline agrees to pay, reasonable charges for the use of additional City-provided facilities, equipment and services, if the related costs have not been included in the calculation of Terminal Building Rental Rate and Landing Fee Rate, or recovered through FIS charges.

Section 5.07 Charges for Non-Signatory Passenger Carriers

- A. Non-signatory Passenger Carriers shall pay the following amounts to the City:
  - 1. For the use of Airfield Area, the product of (a) Landed Weight and (b) One Hundred and Twenty-five Percent (125%) of Landing Fee Rate;
  - 2. For the use of Terminal Building:
    - a. Security Fee calculated as Enplaned Passengers multiplied by One Dollar and Twenty-five Cents (\$1.25) for the initial term.
      - i. If the first and second option to extend are approved by the Signatory Passenger Airlines, the City may, at its discretion, adjust the Security Fee rate prior to the end of each term period in accordance with Section 5.06(A) above.
    - b. The product of (a) Exclusive Use Space, if any, and (b) One Hundred and Twenty-five Percent (125%) of Terminal Building Rental Rate
    - c. Non-Signatory Terminal Use Fee multiplied by Enplaned Passengers of the Non-Signatory Passenger Carrier.



- B. For the use of FIS Facility, the product of (a) FIS Users of the Non-Signatory Passenger Carrier and (b) One Hundred and Twenty-five Percent (125%) of FIS Fee Rate.
- C. Other charges that may be established by the City pursuant to Section 5.06.

Section 5.08 Charges for Non-Signatory Charter Carrier

The City shall charge Non-Signatory Charter Carriers fees and charges published in the Master Fee Schedule.

Section 5.09 Passenger Facility Charge (PFC)

- A. City shall have the right to assess passengers a PFC for the use of the Airport in accordance with the requirements of 14 CFR Part 158 ("PFC Regulations") and any other relevant governmental directives, statutes, orders or provisions. In accordance therewith and to the extent required by 14 CFR Part 158, the Collecting Carrier shall collect on behalf of and remit to City any such PFC charges. Any charges so collected shall, pending remittance to City, be held in trust in accordance with federal law. City shall have the right to use all such passenger facility charges collected in any lawful manner.
- B. Collecting Carrier and City shall be bound by and shall observe all of the provisions of 14 CFR Part 158 and any other relevant governmental directives, statutes, orders or provisions, as they apply to either or both parties.
- C. If Collecting Carrier fail(s) to collect, maintain in trust and remit PFC revenue to the City within the time limits and in the manner established by federal regulation, Collecting Carrier shall be deemed to be in default of this Agreement. Any late payment of PFCs shall be subject to interest compounded in accordance with Section 5.14, to the extent allowed by law.
- D. PFCs to be Held in Trust for the City
  - 1. In the event that Collecting Carrier fails to make payments of PFCs to City in accordance with the PFC Regulations and within ten (10) calendar days after receipt of a written notice of non-payment from City, City may require Collecting Carrier to establish a PFC trust account pursuant to this section 5.09. In the event City requires Collecting Carrier to establish a PFC trust account, and notwithstanding Section 158.49 of the PFC Regulations, upon receipt of PFCs that are collected by Collecting Carrier, Collecting Carrier shall at its own cost establish and shall deposit the net principal amount of such PFCs in a trust account for City's benefit (the "Trust Account"). City and Collecting Carrier agree that the Trust Account shall be held in the name of Collecting Carrier as trustee for City provided that City and Collecting Carrier mutually agree to terms upon which amounts may be withdrawn from such account upon the joint direction of City and Collecting Carrier. If City and Collecting Carrier do not so

agree, the Trust Account shall be held by an independent third party bank trustee, in which event such trustee's fees shall be payable by City. City shall have the right to select such trustee subject to the approval of the Collecting Carrier which approval will not be unreasonably withheld. The Trust Account shall be separate from and not commingled with all other Collecting Carrier funds, including PFCs collected on behalf of other airports. In accordance with Section 158.51 of the PFC Regulations, any amounts required to be remitted to City under such section shall be paid in any event by Collecting Carrier, as trustee, or by such third party bank trustee, to City on or before the date specified in such section first out of the net principal amount, then, to the extent of any deficiency, by Collecting Carrier, out of income earned thereon and then, by Collecting Carrier, out of any available funds of Collecting Carrier. Funds in the Trust Account shall be invested solely in instruments issued or guaranteed by the United States government or any of its agencies, commercial paper rated A 1 or P1 or better by, respectively, Standard & Poors or Moody's Investor Service, or federally insured bank certificates of deposit. Any income earned on funds in the Trust Account on or prior to the date of required remittance to City shall be the property of the Collecting Carrier and shall be paid directly to Collecting Carrier. Any income earned on funds in the Trust Account after the date of required remittance to City shall be the property of the City and shall be paid immediately to City. If Collecting Carrier, as trustee for City, timely and properly funds and administers the Trust Account and pays over to the City the PFCs in accordance with PFC Regulations and this Agreement for a period of eighteen (18) consecutive months, then Collecting Carrier may submit a written request to City that the Trust Account be terminated and that Collecting Carrier collect the PFCs in accordance with the provisions of this Section 5.09. City shall not unreasonably deny Collecting Carrier's request. The City shall have the right to apply the provisions of this Section each time Collecting Carrier fails to timely remit PFCs in accordance with the PFC Regulations and within ten (10) days of written notice of non-payment from City.

2. In the absence of additional regulations governing the treatment of refunds, any refunds of PFCs due to passengers as a result of changes of itinerary shall be paid proportionately out of the net principal amount attributable to such PFCs and the amount that Collecting Carrier was permitted to retain under section 158.53 (a) of the PFC Regulations attributable to such PFCs. Collecting Carrier hereby acknowledges that the net principal amount of all PFCs collected on behalf of City shall remain at all times property of City except to the extent of amounts refunded to passengers pursuant to the preceding sentence (which shall remain the property of City until refunded and become the property of the passenger upon and after refund). Other than the amounts that Collecting Carrier is entitled to retain pursuant to Section 158.53 of the PFC Regulations, Collecting Carrier shall be entitled to no compensation.

Section 5.10      Rate Adjustment

If, at any time during any Fiscal Year, the City estimates that the total costs attributable to the Terminal Building and Airfield Area Cost Centers, or the aggregate Landed Weight for Passenger Carriers and Cargo Carriers, or the enplanement forecast, will vary 10% or more from the estimates used in setting Airline Rates and Charges in accordance with the provisions of Article 5, such rates may be adjusted based on the new estimates and in accordance with the principles and procedures set forth in this Article. The City shall notify Airline of any such rate adjustment, along with a written explanation of the basis for such rate adjustment, 30 days prior to the effective date of the new rates. Unless extraordinary circumstances warrant additional adjustments, the City shall limit any such rate adjustments to no more than once during each Fiscal Year.

During any Fiscal Year, if the City anticipates that the minimum annual debt service coverage ratio of 1.25 times may not be met, as required by the Rate Covenant, the City will adjust Airlines Rates and Charges as necessary, including using Rentable Space instead of Usable Space in Section 5.02 Item A.8, and modifying Airfield Area Credits in Section 5.03 item B.

Section 5.11 Annual True-up

- A. As soon as possible following the completion of the annual audit for a Fiscal Year, the City shall recalculate Airline Airfield Area Net Requirement, Airline FIS Net Requirement, and Airline Terminal Building Net Requirement based on actual audited data, and compare actual requirements to collected requirements. Variances shall be addressed as detailed below:
1. If the actual Airline Airfield Area Net Requirement exceeds the collected Airline Airfield Area Net Requirement, the underpayment shall be added to the Airline Airfield Area Net Requirement in the ensuing Fiscal Year.
  2. If the actual Airline FIS Net Requirement exceeds the collected Airline FIS Net Requirement, the underpayment shall be added to the Airline FIS Net Requirement in the ensuing Fiscal Year.
  3. If the actual Airline Terminal Building Net Requirement exceeds the collected Airline Terminal Building Net Requirement, the underpayment shall be divided by the Leased Premises of Passenger Carriers and add to the calculation of Terminal Building Rental Rate in the ensuing Fiscal Year.
  4. If the actual Airline Airfield Area Net Requirement is less than collected Airline Airfield Area Net Requirement, the overpayment shall be subtracted from the Airfield Area Net Requirement in the ensuing Fiscal Year.
  5. If the actual Airline FIS Net Requirement is less than collected Airline FIS Net Requirement, the overpayment shall be subtracted from the Airline FIS Net Requirement in the ensuing Fiscal Year.
  6. If the actual Airline Terminal Net Requirement is less than collected Airline Terminal Net Requirement, the overpayment shall be divided by the Leased

Premises of Passenger Carriers and be subtracted from the calculation of Terminal Building Rental Rate in the ensuing Fiscal Year.

- B. For the Annual True-up for the last two Fiscal Years of this Agreement - FY 2026 and FY 2027 if no option to extend is exercised, or FY 2034 and FY 2035 if both options to extend are exercise:
1. If the actual Airline Airfield Area Net Requirement, Airline FIS Net Requirement, and Airline Terminal Building Net Requirement exceed the respective collected amounts, the underpayment shall be billed to Signatory Passenger Carriers and Signatory Cargo Carriers (when applicable) based on the difference in the Landing Fee Rate, the FIS Fee Rate, and the Terminal Building Rental Rate respectively, and invoices shall be due and payable within sixty (60) days of invoice.
  2. If the actual Airline Airfield Area Net Requirement, Airline FIS Net Requirement, and Airline Terminal Building Net Requirement are less than the respective collected amounts, the overpayment shall be credited to Signatory Passenger Carriers and Signatory Cargo Carriers (when applicable) based on the difference in the Landing Fee Rate, the FIS Fee Rate, and the Terminal Building Rental Rate respectively, starting after the month of the Annual True-up calculation.
  3. Any overpayment made by an Airline will be paid to the airlines if there is no future Agreement between the Airline and the City.

Section 5.12 Signatory Credit

- A. The City shall calculate the Signatory Credit, as depicted in **Exhibit H** attached hereto and incorporated herein, based on actual audited data.
1. Twenty-five Percent (25%) of the Signatory Credit shall be allocated to the Signatory Passenger Carriers and Signatory Cargo Carriers based on their share of total Landed Weight of Signatory Passenger Carriers and Signatory Cargo Carriers for the Fiscal Year being calculated.
  2. Sixty-five Percent (65%) of the Signatory Credit shall be allocated to the Signatory Passenger Carriers based on their share of total Enplaned Passengers of Signatory Passenger Carriers for the Fiscal Year being calculated.
  3. Ten percent (10%) of the Signatory Credit shall be allocated to the Signatory Passenger Carriers based on their share of total FIS Users of Signatory Passenger Carriers for the Fiscal Year being calculated.
- B. All or a portion of the Signatory Credit, if any, shall be prorated over the remaining months of the then-current Fiscal Year, and shall be applied as a monthly credit to the Airline Rates and Charges invoiced to the Signatory Passenger Carriers and

Signatory Cargo Carriers, subject to annual maximum amount of two million dollars (\$2,000,000). The unused amount of the Signatory Credit, if any, shall continue to be applied in the ensuing Fiscal Year.

- C. The cumulative amount of the Signatory Credit earned during the initial term of this Agreement shall not exceed seven million and five hundred thousand dollars (\$7,500,000).
- D. If Airline ceases operation at the Airport, resulting in Signatory Credit exceeding the remaining invoice amount, the difference shall be kept by the City and used for any lawful purposes.
- E. To the extent that Rate Covenant is not projected to be met in a given Fiscal Year, the City shall have the right to postpone the Signatory Credit.

Section 5.13 Monthly Activity Report

- A. Airline shall furnish to Director of Aviation on or before the fifteenth (15th) day of each month, an accurate written report of Airline's operations at the Airport during the preceding month, setting forth all data necessary to calculate the rentals, fees, and charges due under this Agreement. The report form shall be provided by the Director of Aviation and shall include, but shall not necessarily be limited to (a copy of the report is attached hereto and incorporated herein as **Exhibit K**):
  - 1. Airline's total number of aircraft arrivals for the month by type of aircraft, the maximum certificated gross landing weight of each aircraft, and the total airline landed weight for the month to include any non-scheduled and charter operations;
  - 2. Total number of enplaning and deplaning passengers of Airline and aircraft of other airlines handled by Airline (so long as those handled airlines are not otherwise required to report on those same aircraft);
  - 3. Weight of cargo freight, mail, and express for the month; and
  - 4. Other such information that City may reasonably request from Airline to prepare airline invoices and establish and assess rates and charges.
- B. If Airline fails to furnish Director of Aviation with the report required by Section 5.13 (A) by the date specified within Section 5.13(A), then Airline's rentals, fees, and charges, as provided for the month thereafter, shall be determined by assuming that Airline's Total Airline Landed Weight and Enplaned Passengers for such month was one hundred twenty-five percent (125%) of its Total Airline Landed Weight and Enplaned Passengers during the most recent month(s) for which such data are available for Airline and by applying the rates of the Fiscal Year. Any necessary adjustment in such rentals, fees, and charges shall be calculated after an accurate report is delivered to Director of Aviation by Airline for the month(s) in

question. Resulting surpluses or deficits shall be applied as credits or charges to the appropriate invoices in the succeeding month(s).

- C. Airline Monthly Activity Report shall be delivered to City at the address below or at such address to which City, by service of written notice upon Airline, may direct the delivery thereof, from time to time:

Via Mail/Express to:  
City of Fresno  
Fresno Yosemite International Airport  
Attn.: Airport Accounting  
4995 East Clinton Way  
Fresno, CA 93727-1504

Via Email:  
FYI.Finance@fresno.gov

Section 5.14 Payment Provisions/Interest on Overdue Amounts

- A. Unless otherwise provided in this Agreement, fixed (i.e. non-activity based) Airport rentals, fees and charges shall be due and payable the first (1st) day of each month, in advance, without invoice.
- B. Unless otherwise provided in this Agreement, variable (i.e. activity based) Airport rentals, fees, and charges shall be due and payable the fifteenth (15th) day of each month following the month in which assessed, without invoice.
- C. Unless otherwise provided in this Agreement, all other rentals, fees, and charges shall be due and payable on invoice within thirty (30) days of the date of the invoice.
- D. The acceptance by City of any payment by Airline shall neither constitute City's approval of, nor preclude City from questioning the accuracy of, computations in Airline's Monthly Activity Report, submitted to City as provided in Section 5.13, or from recovering any additional payment actually due from Airline.
- E. Any payment not received by the due date shall be deemed delinquent and shall accrue interest at the lesser of the rate of eighteen percent (18%) per year calculated on a daily basis at the rate of five-hundredths of a percent (0.05%) per day from the due date until paid in full, or the maximum rate allowed by law.
- F. All payments due and payable herein shall be paid in lawful money of the United States of America, without set off, by check or wire transfer made payable to City and delivered or wired, as applicable, to the following address or account, or to such other address or account as City by service of written notice upon Airline, may otherwise direct the payment thereof from time to time during the term hereof:

Via Mail/Express  
City of Fresno - Airports  
Fresno Yosemite International Airport  
Attn.: Airport Accounting

4995 East Clinton Way  
Fresno, CA 93727-1504

Section 5.15 Taxes

Airline shall pay all taxes of whatever character that may be lawfully levied, assessed, or charged upon the property, real and personal, occupied, used, or owned by Airline, or upon the rights of Airline to occupy and use the premises and emolument received thereby, or upon Airline's rights or operations hereunder or services provided by Airline at the Airport. Airline shall have the right, at its sole cost and expense, to contest the amount or validity of any tax.<sup>1</sup>

Section 5.16 Records of Airline

Airline shall make available to City, upon the written request of the City, at the offices of the Airline at the Airport such books, records and accounts, or photocopies thereof, that are relevant to payment of rentals, fees and charges required under this Agreement for the current year and the preceding calendar year, and shall make such records, or photocopies thereof, available for inspection and audit by City or its authorized representative at reasonable and mutually agreed upon hours and times during the entire term of this Agreement and for two (2) years thereafter.

Section 5.17 Right of Set Off

The City shall have the right to set off any past due amount(s) by applying all or a portion of current payments to such past due amount(s). In the event a disputed charge becomes past due, if resolved in favor of Airline, said overpaid amounts shall be credited to the next amount due under this Agreement. If the Agreement is terminated, it shall be credited to amounts due by or to Airline. Past due amounts may include sums due on prior agreements, this Agreement or for usage of the Airport as a Non-Signatory Airline. In the event the City exercises the right, it shall notify Airline. Airline shall be responsible for promptly submitting such a sum as will reflect the total amount needed to satisfy current amounts due. Regardless of the foregoing, City shall not have the right to offset past due amounts which Airline has notified the City, in writing, are disputed by Airline, provided that such written notice shall not prevent or limit the right of City to exercise any other right or remedy available to City under this Agreement or at law or in equity as a result of the non-payment of the amount in dispute by Airline.

**ARTICLE 6 – SECURITY DEPOSIT**

Section 6.01 Due Date, Type, Form and Amount of Surety

---

<sup>1</sup> Any interest in real property which exists as a result of possession, exclusive use, or a right to possession or exclusive use of any real property (land and/or improvements located therein or thereon) which is owned by the City of Fresno (City) is a taxable possessory interest unless the possessor of interest in such property is exempt from taxation. With regard to any possessory interest to be acquired by Airline under this Agreement, Airline, by its signatures hereunto affixed, warrants, stipulates, confirms, acknowledges and agrees that, prior to executing this Agreement, Airline either took a copy of this Agreement to the office of the Fresno County Tax Assessors or by some other appropriate means independent of City or any employee, agent, or representative of City determined, to Airline's full and complete satisfaction, how much Airline will be taxed, if at all.

Airline shall provide to City a Security Deposit in an amount equal to three (3) months Agreement Rents, Fees, and Charges. Such deposit shall be in the form of: (i) cash; (ii) a Surety Bond issued by an insurance company authorized to do business in the State of California and authorized to write such bonds in said State; or (iii) a non-revocable Letter of Credit established in favor of City for the account of Airline by a federally chartered bank acceptable to City, guaranteeing the faithful performance of all of the covenants and conditions herein to be performed by Airline. Upon the expiration or termination of this Agreement, and the payment of all fees and charges due to the City for the privileges granted in this Agreement, the Security Deposit shall be refunded or the surety instrument returned to Airline, provided there are no other outstanding claims or charges against Airline by City. City shall not be required to pay, and City shall not pay, any interest on this Security Deposit.

Section 6.02 Drawdowns by City

If Airline defaults with respect to any provision of this Agreement (and such default extends beyond any applicable cure period provided in this Agreement), including but not limited to the provisions relating to payment of rentals, fees and charges or any other sums due and owing, City may, to the extent allowed by law, with or without prior notice to Airline (except as otherwise required herein), draw down on the surety provided by Airline, up to the full amount thereof, and apply such draw on amount(s) to correct any default by Airline, to pay any rentals or other sums in default by Airline, to reimburse City for any amount(s) which City may spend or become obligated to spend by reason of Airline's default, to compensate City for any other loss or damage which City may suffer by reason of Airline's default, or to pay any amount due or owing upon expiration or earlier termination of this Agreement.

- A. Within fifteen (15) calendar days following any draw on and application by City of any part or the entire surety amount provided by Airline, City shall provide Airline with notice of such draw on and application, in writing.
- B. In the event the amount of surety provided City by Airline shall, at any time and from time to time during the life hereof be reduced pursuant to the draw down provisions of this Agreement, Airline shall, within ten (10) days after written demand therefore is served upon Airline by City, deposit additional surety with City in a sum sufficient to restore the required surety to its currently obligatory amount.
- C. In the event City finds it necessary to draw down on the surety instrument more than two times for any reason, the third draw down shall itself constitute grounds for default and breach of this Agreement by Airline.

Section 6.03 Return/Surrender/Release of Surety by City

The surety instrument shall be returned to Airline not later than sixty (60) days after termination of this Agreement, provided there are no outstanding claims against the Airline by City.



## ARTICLE 7: INDENTURE OF TRUST

### Section 7.01 Subordination to Indenture of Trust

This Agreement and all rights of Airline hereunder are expressly subordinated and subject to the lien and provisions of any pledge, transfer, hypothecation, or assignment made at any time by City pursuant to the terms, covenants (including the Rate Covenant), and conditions of the Indenture of Trust, Supplemental Indentures, and future indentures. In conflicts between this Agreement and the Indenture of Trust, the Indenture of Trust shall govern. All definitional terms that are not specifically defined herein are to have the meanings set forth in the Indenture of Trust.

### Section 7.02 Flow of Funds

Subject to the terms and provisions of the Indenture of Trust and other related instruments, it is mutually understood and agreed that, as long as any Bonds secured by the Indenture of Trust are outstanding, bond proceeds and all Airport revenues shall be deposited, maintained, and paid as set forth in the Indenture of Trust.

## ARTICLE 8: MAINTENANCE AND OPERATION OF AIRPORT

### Section 8.01 City's Responsibilities

In accordance with **Exhibit I**, attached hereto and incorporated herein, and except to any extent otherwise expressly provided in this Agreement:

- A. City agrees that it will, with reasonable diligence, keep the Airport and its aerial approaches reasonably free from obstruction and interference for the safe and proper use thereof by Airline; and will develop, maintain, and operate the Airport in all respects in a manner at least equal to the standards or rating established by the FAA and any other governmental agency having jurisdiction thereof, except for conditions beyond the reasonable control of City. City shall not be liable to Airline for temporary failure to so perform, whether due to mechanical breakdown or for any other causes beyond the reasonable control of City.
- B. City, with its own forces or by contract, shall operate and maintain and keep in good condition the Terminal Building and all additions, improvements, facilities, and equipment now or hereafter provided by City at or in connection with the Terminal Building, except any improvements, facilities, and equipment constructed or installed by Airline and any Exclusive Use Space hereunder. City shall keep the Terminal Building, except Airline's Exclusive Use Space, in a neat, orderly, sanitary, and presentable condition.
- C. Consistent with this Agreement and constitutional and local law requirements City, with its own forces or by contract, shall at all times maintain the structure of all Leased Premises and repair latent defects in facilities provided by City.

- D. Consistent with this Agreement and constitutional and local law requirements City, with its own forces or by contract, shall at all times maintain the public and Common Use space areas of the Terminal Building so as to provide for reasonable unobstructed use thereof by passengers and invitees, and shall keep such area adequately supplied, equipped (including directional signs), furnished, and decorated.
- E. City shall supply or cause to be supplied appropriate and adequate equipment and maintenance for air conditioning, lighting, ventilation, heat, electrical, water, and sewerage facilities for Terminal Building public use areas and Airline's Leased Premises; adequate illumination in Common Use Space; and janitorial service in Terminal Building public use areas and Common Use Space.

Section 8.02 Airlines Responsibilities

Subject to the provisions of this Section 8.02 and in accordance with **Exhibit I**:

- A. Airline shall, at all times, keep its Exclusive Use Space and Preferential Use Positions neat, orderly, sanitary, and presentable. Airline shall pay for all electric power used in its Exclusive Use Space and preferentially assigned loading bridges; shall be responsible for re-lamping and shall furnish its own janitorial service for its Exclusive Use Space; and shall cause to be removed at Airline's own expense from its Exclusive Use Space and Preferential Use Positions all waste, garbage, and rubbish, and agrees not to deposit the same on any part of the Airport, except that Airline may deposit same temporarily in its Exclusive Use Space or in space designated by Director of Aviation in connection with collection for removal.
- B. Airline shall maintain the apron area contiguous to its assigned Gates in a neat, clean, and orderly condition, free from litter, debris, refuse, petroleum products, or grease, and immediately remove all oil and grease spillage from its Aircraft Parking Positions that is attributable to Airline's activities, aircraft or equipment.
- C. Airline shall perform, at its sole expense, ordinary preventive maintenance and ordinary upkeep and repair (except structural repairs and repairs necessitated by latent defects in facilities provided by City) of its Exclusive Use Space including, but not limited to, all facilities, personal property, trade fixtures, and equipment. For purposes of this Section, structural repairs are defined as repairs to the roof, insulation, foundation and exterior walls of the Terminal Building.
- D. Airline shall immediately repair any damage in any other space at the Airport occasioned by the activities, fault or negligence of Airline, its servants, agents, employees, licensees, passengers, and invitees at its sole expense.
- E. Airline shall not erect, maintain, or display on its Leased Premises or anywhere in the Terminal Building in the public view any billboards, banners, advertising, promotional signs, or materials without the prior written approval of Director of Aviation.

- F. Airline expressly agrees that City shall not be liable to Airline, for bodily injury or for any loss or damage to real or personal property occasioned by flood, fire, earthquake, lightning, windstorm, hail, explosion, riot, strike, civil commotion, smoke, vandalism, malicious mischief, or acts of civil authority.
- G. Airline shall provide and maintain hand fire extinguishers for the interior of its Exclusive Use Space in accordance with applicable safety codes.
- H. Airline shall, in conducting any activity or business at the Airport, including environmental responses or remedial activities, comply with all applicable Environmental Laws, as discussed in detail in Section 14.19.

Section 8.03 City's Right to Inspect and Make Repairs

City, by its Director of Aviation or authorized officers, employees, agents, contractors, subcontractors, and other representatives, shall have the right at any time in the case of emergencies or upon request of the Airline, otherwise during normal business hours upon reasonable notice to Airline, and in any event in a manner as to not unreasonably interfere with Airline's normal operations, to enter upon Airline's Exclusive Use Space, accompanied by an authorized Airline representative, if practicable, for the following purposes:

- A. To inspect such space to determine whether Airline has complied and is in compliance with the terms and conditions of this Agreement.
- B. Upon reasonable notice and opportunity to perform, except in emergencies, to perform such maintenance, cleaning, or repair as City reasonably deems necessary, if Airline fails to perform its obligations under Section 8.02, and to recover the actual cost of such maintenance, cleaning, or repair from Airline, plus a fifteen percent (15%) administrative charge from Airline upon invoice.
- C. Upon reasonable notice, except in emergencies, to perform such maintenance, cleaning, or repair as City reasonably deems necessary, and which is the responsibility of the City under this Agreement.

Section 8.04 Alterations and Improvements

- A. Airline shall make no repairs, alterations, additions, improvements to, or installations on the Leased Premises without the prior written approval of City or Director of Aviation.
- B. Plans and specifications for any such work shall be filed with and subject to the approval of City and Director of Aviation and all work shall be done in accordance with local ordinances and California and Federal laws and regulations.

- C. All Airline alterations and improvements other than movable furniture, personal property, equipment, and trade fixtures shall become part of the realty and title shall vest with City at City's option and without cost, upon expiration, or early termination, of this Agreement.

Section 8.05 Payment Bond

Prior to the commencement of any improvements, City shall have the right to require that Airline obtain, or cause to be obtained, a contract surety bond, or such other form of security acceptable to City, in a sum equal to the full amount of the construction contract awarded by Airline for the improvements. Said bond shall name City as an obligee thereunder and shall be drawn in a form and from such company acceptable to City and licensed to do business in the State of California; shall guarantee the faithful performance of necessary construction and completion of improvements in accordance with approved final plans and detailed specifications; and shall protect City against any losses and liability, damages, expenses, claims and judgments caused by or resulting from any failure to perform completely the work described. City also reserves the right to require that Airline acquires or causes to be acquired a payment bond with any contractor or contractors of Airline, as principal, in the sum equal to the full amount of the improvement contract awarded by Airline for the improvements. Said bond shall name the City as an obligee thereunder and shall guarantee payment of all wages for labor and services engaged, and of all bills for materials, supplies, and equipment used in the performance of said improvement contract. Any work associated with such improvement shall not unreasonably interfere with the operation of the Airport, or otherwise unreasonably interfere with the permitted activities of other Airport tenants and users. Upon completion of approved improvement and within sixty (60) days of Airline's receipt of a certificate of occupancy, a complete set of as-built drawings shall be delivered to the City in a media type and format acceptable for the permanent record of the City.

Section 8.06 Leasehold Improvements

Airline shall be solely responsible for payment of all leasehold improvements made by Airline. Airline shall be solely responsible for submitting all improvement requests through the City's Tenant Improvement Request form with reasonable time for the City to respond to said request.

Section 8.07 Debts, Liens, Mortgages

Airline shall pay promptly when due and owing, all bills, debts and obligations incurred by Airline in connection with its operations or activities on Leased Premises at the Airport, and shall not permit the same to become delinquent. Except as expressly approved by City in writing, Airline shall not permit any mechanics' or material men or any other lien to be attached to or be foreclosed upon Leased Premises at the Airport or improvements thereto. Airline shall suffer no lien, mortgage, judgment, or execution to be filed against the Leased Premises at the Airport or improvements thereon. If any lien shall be filed against the Leased Premises, Airline shall take action, including the payment of and/or

bonding against the amount of the lien, to cause such lien to be removed within twenty (20) business days of recordation of the lien.

## **ARTICLE 9: DAMAGE OR DESTRUCTION OF PREMISES**

### **Section 9.01     Damage or Destruction**

- A.     If the Airline Leased Premises or any portions thereof, or buildings or structures of which space may be a part, are damaged by fire or other casualty not caused by Airline, Director of Aviation shall notify Airline within sixty (60) days whether the space will be repaired. If the space is to be repaired, it shall be repaired with due diligence by City, and the rent allocable to the particular building, rooms, or other portion of the space rendered untenable shall be abated for the period from the occurrence of the damage to the completion of the repairs, provided that City shall exert its best effort to provide Airline with temporary substitute space, if available, at such rent as deemed necessary and reasonable by City, until such time as the repairs are completed. City shall provide a credit to the Airline's account for any amounts deemed to be paid in advance for all or the portion of the Leased Premises rendered untenable.
  
- B.     For damage, not caused by Airline, Airline shall notify Director of Aviation in writing within 30 days, if Airline will not be able to operate to its reasonable satisfaction without repair of the damaged space.
  
- C.     If the Director of Aviation shall fail to notify Airline of its decision within sixty (60) days after destruction, City shall be deemed to have elected to terminate the provision of this Agreement as to only the space damaged and destroyed. The specific location, and the Agreement shall automatically terminate as to such space as of the date of the damage or the entire Agreement if Airline is not able to operate to its reasonable satisfaction as a result of the damage, provided Airline gave timely notice as required in 9.01B above. In such case, any amounts due under this Agreement shall be proportionately abated from the time of such damage, and City shall reimburse Airline for any amounts paid in advance for all or the portion of the Leased Premises rendered untenable, provided there are no past due amounts on the account.

## **ARTICLE 10: INDEMNIFICATION, INSURANCE AND RELEASE**

### **Section 10.1     Indemnification**

- A.     Except to any extent expressly provided for in this Agreement, and to the furthest extent allowed by law, Airline shall indemnify, hold harmless and defend City and its officers, officials, employees, agents and volunteers (referred to in this Article 10 collectively as "City") from any and all loss, liability, fines, penalties, forfeitures, costs and damages (whether in tort or strict liability including damage by fire or other casualty) alleged to have been incurred by City or Airline, and from any and all claims, demands and actions in law or equity (including reasonable attorney's fees and litigation expenses) arising or alleged to have arisen directly or indirectly

out of Airline's: (i) occupancy, maintenance, and/or use of the Leased Premises; (ii) use of any Common Use Space, and/or Exclusive Use Space, upon which the Leased Premises is located; or (iii) performance of, or failure to perform, its obligations under this Agreement. Airline's obligations under the preceding sentence shall not apply to any loss, liability, fines, penalties, forfeitures, costs, or damages caused solely by the gross negligence or willful misconduct of City.

- B. Airline acknowledges that any and all loss, liability, fines, penalties, forfeitures, costs and damages (whether in contract, tort or strict liability, including but not limited to personal injury, death at any time and property damage, including damage by fire or other casualty) arising out of or in any way connected with releases or discharges of a Hazardous Material, or the exacerbation or creation of an environmental hazard, occurring as a result of: (i) Airline's occupancy, maintenance and/or use of the Leased Premises; (ii) Airline's use of any Common Use Space and/or Exclusive Use Space, upon which the Leased Premises is located; (iii) Airline's activities or the activities of any of Airline's representatives (including, without limitation, any of Airline's officers, officials, employees, agents, volunteers, invitees, subtenants, consultants, subconsultants, contractors or subcontractors), and all reasonable costs, expenses and liabilities for environmental investigations, monitoring, containment, abatement, removal, repair, cleanup, restoration, remediation and other response costs, including reasonable attorneys' fees and disbursements and any fines and penalties imposed for the violation of any legal requirements relating to the environment or human health, are expressly within the scope of the indemnity set forth above. Except to the extent caused by: (1) solely by the gross negligence of City; or (2) a third party not contractually related to Airline; or (3) resulting from a condition existing prior to Airline's first occupancy of the Leased Premises.
- C. Airline's occupancy, maintenance and use of the Leased Premises, and use of all or any part of Airport, including, but not limited to, use of any Common Use Space and/or Exclusive Use Space, upon which the Leased Premises is located, shall be at Airline's sole risk and expense. Airline accepts all risk relating to Airline's: (i) occupancy, maintenance and/or use of the Leased Premises; (ii) Airline's use of any Common Use Space, Exclusive Use Space, upon which the Leased Premises is located; or (iii) performance of, or failure to perform, this Agreement City shall not be liable to Airline and its insurer(s) for, and Airline and its insurer(s) hereby waive and release City from, any and all loss, liability, fines, penalties, forfeitures, costs or damages resulting from or attributable to an occurrence on or about the Leased Premises, or all or any part of the Airport, including, but not limited to, use of any Common Use Space and/or Exclusive Use Space, upon which the Leased Premises is located, in any way related to the Airline's operations and activities. This waiver shall not extend to any and all loss, liability, fines, penalties, forfeitures, costs, or damages caused solely by the gross negligence, or by the willful misconduct of City.
- D. Airline shall immediately notify City of any occurrence arising from Airline's use of any Common Use Space and Exclusive Use Space, upon which the Leased

Premises is located, resulting in injury or death to any person or damage to property of any person.

- E. If Airline should contract any work on the Leased Premises or subcontract any of its obligations under this Agreement, Airline shall require each consultant, subconsultant, contractor and subcontractor to indemnify, hold harmless and defend City and its officers, officials, employees, agents and volunteers in accordance with the terms of this Section.
- F. The provisions of this Section shall survive the termination or expiration of this Agreement.

Section 10.2 Insurance

- A. Throughout the life of this Agreement, Airline shall pay for and maintain in full force and effect all policies of insurance required hereunder with an insurance company(ies) either (i) admitted by the California Insurance Commissioner to do business in the State of California and rated not less than "A-VII" in Best's Insurance Rating Guide, A+ in S&P Global's Ratings, or (ii) authorized in writing by City's Risk Manager or his/her designee. The following policies of insurance are required:

- (i) COMMERCIAL GENERAL LIABILITY insurance which shall be at least as broad as Insurance Services Office (ISO) form CG 00 01 and shall include coverage for "bodily injury", "property damage" and "personal and advertising injury", including premises and operation, products and completed operations, and contractual liability with limits of liability of not less than \$5,000,000 per occurrence for bodily injury and property damage, \$1,000,000 per occurrence for personal and advertising injury, \$5,000,000 aggregate for products and completed operations and \$10,000,000 general aggregate. Airline may substitute Airport Liability insurance for this insurance provided the coverage is as broad as required and the limits of liability are not less than required.

- (ii) AIRCRAFT LIABILITY insurance shall include coverage for bodily injury to passengers and non-passengers, property damage and cargo legal liability with combined single limits of liability of not less than \$100,000,000 per occurrence for bodily injury, property damage and cargo legal liability for aircraft under 60,000 GTW and \$350,000,000 per occurrence for bodily injury, property damage and cargo legal liability for aircraft over 60,000 GTW.

- (iii) COMMERCIAL AUTOMOBILE LIABILITY insurance which shall be at least as broad as the most current version of Insurance Service Office (ISO) Business Auto Coverage Form CA 00 01, and include coverage for all owned, hired, and non-owned automobiles or other licensed vehicles (Code 1 - Any Auto) with limits of liability of not less than \$5,000,000 per accident for bodily injury and property damage.

(iv) WORKERS' COMPENSATION insurance as required under the California Labor Code.

(v) EMPLOYERS' LIABILITY insurance with limits of liability of not less than \$1,000,000 each accident, \$1,000,000 disease policy limit and \$1,000,000 disease each employee.

(vi) POLLUTION LIABILITY insurance with limits of liability of not less than \$1,000,000 per claim/occurrence and \$2,000,000 aggregate; provided, however, Airline may self-insure for all or any part of the pollution liability limits required by this Section 1(f).

- B. In the event Airline purchases an Umbrella or Excess insurance policy(ies) to meet the minimum limits of insurance set forth above, this insurance policy(ies) shall "follow form" and afford no less coverage than the primary insurance policy(ies). In addition, such Umbrella or Excess insurance policy(ies) shall also apply on a primary and non-contributory basis for the benefit of the City, its officers, officials, employees, agents and volunteers.
- C. Airline shall be responsible for payment of any deductibles contained in any insurance policies required hereunder and Airline shall also be responsible for payment of any self-insured retentions. At no time shall City be responsible for the payment of any deductibles or self-insured retentions. Any deductibles or self-insured retentions must be declared to, and approved by, the City's Risk Manager or his/her designee. At the option of the City's Risk Manager or his/her designee, as respects to any deductibles or self-insured retention Airline shall provide a financial guarantee, satisfactory to City's Risk Manager or his/her designee, guaranteeing payment of losses and related investigations, claim administration and defense expenses. At no time shall City be responsible for the payment of any deductibles or self-insured retentions.
- D. All policies of insurance required hereunder shall be endorsed to provide that the coverage shall not be cancelled, reduced in coverage or in limits except after 30 calendar day written notice has been given to City. Upon issuance by the insurer, broker, or agent of a notice of cancellation, non-renewal, or reduction in coverage or in limits, Airline shall furnish City with a new certificate and applicable endorsements for such policy(ies). In the event any policy is due to expire during this Agreement, Airline shall provide a new certificate, and applicable endorsements, evidencing renewal of such policy prior to the expiration date of the expiring policy.
- E. The General Liability (or Airport Liability, if applicable), Aircraft Liability, Pollution and Automobile Liability insurance policies shall be written on an occurrence form and shall name City, its officers, officials, agents, employees and volunteers as an additional insured. Such policy(ies) of insurance shall be endorsed so Airline's insurance shall be primary and no contribution shall be required of City. The



coverage shall contain no special limitations on the scope of protection afforded to City, its officers, officials, employees, agents, and volunteers. All policies of insurance including the Workers' Compensation insurance policy shall contain a waiver of subrogation as to City, its officers, officials, agents, employees, and volunteers.

- F. Airline shall furnish City with all certificate(s) and applicable endorsements effecting coverage required hereunder. All certificates and applicable endorsements are to be received and approved by the City's Risk Manager or his/her designee prior to City's execution of the Agreement. Such evidence of insurance shall be provided City at the following address:

City of Fresno - Airports Department  
Properties Division  
4995 E. Clinton Way  
Fresno, CA 93727  
Or via email at FYI.Properties@fresno.gov

- G. Any failure to maintain the required insurance shall be sufficient cause for City to terminate this Agreement. No action taken by City hereunder shall in any way relieve Airline of its responsibilities under this Agreement.
- H. The fact that insurance is obtained by Airline shall not be deemed to release or diminish the liability of Airline, including, without limitation, liability under the indemnity provisions of this Agreement. The duty to indemnify City and its officers, officials, employees, agents and volunteers shall apply to all claims and liability regardless of whether any insurance policies are applicable. The policy limits do not act as a limitation upon the amount of indemnification to be provided by Airline. Approval or purchase of any insurance contracts or policies shall in no way relieve from liability nor limit the liability of Airline.
- I. Airline and its insurers hereby waive all rights of recovery against City and its officers, officials, employees, agents and volunteers, on account of injury, loss by or damage to the Airline or its officers, officials, employees, agents, volunteers, invitees, consultants, subconsultants, contractors and subcontractors, or its property or the property of others under its care, custody, and control. Airline shall give notice to its insurers that this waiver of subrogation is contained in this Agreement. This requirement shall survive termination or expiration of this Agreement.
- J. If Airline should contract any work on the Premises or subcontract any of its obligations under this Agreement, Airline shall require each consultant, subconsultant, contractor and subcontractor to provide insurance protection in favor of City and its officers, officials, employees, agents and volunteers in accordance with the terms of each of the preceding paragraphs, except that the consultants', subconsultants', contractors' or subcontractors' certificates and

endorsements shall be on file with Airline and City prior to the commencement of any work by the consultant, subconsultant, contractor or subcontractor.

Section 10.3 Non-liability of City

- A. Without wavier or limitation, City shall not in any event be liable for any acts or omissions of Airline, its officers, officials, employees, agents, volunteers, invitees, consultants, subconsultants, contractors or subcontractors, or for any conditions resulting from the operations or activities of airline, its officers, officials, employees, agents, volunteers, invitees, consultants, subconsultants, contractors or subcontractors, or for any conditions resulting from the operations or activities of any other airline, tenant, concessionaire, vendor, supplier, consultant, subconsultant, contractor, subcontractor or invitee, however caused.
- B. City shall not be liable for Airline's failure to perform any of its obligations under this Agreement or for any delay in the performance thereof, nor shall any such delay or failure be deemed a default by City.

**ARTICLE 11: ASSIGNMENT AND SUBLETTING**

Section 11.01 Merger, Assignment and Subletting

Airline shall not at any time, directly or indirectly, transfer, convey, sublet, mortgage, pledge, or encumber its interest under this Agreement, or any part of the Leased Premises without the advance written approval of City, which approval shall not be unreasonably withheld or delayed. Regardless of the foregoing, Airline may without City's approval assign its interest under this Agreement to any person, firm, or corporation with which Airline may merge or consolidate or which may succeed to the business of Airline, and Airline shall give written notice to Director of Aviation of any such assignment and/or assignment and assumption as soon as practical, but not later than sixty (60) calendar days prior to such merger, consolidation, acquisition or succession, but shall not be required to provide non-public information.

Section 11.02 Relinquishment of Space

If Airline desires to relinquish any of its Exclusive Use Space, Airline will notify Director of Aviation in writing of the space available, and City or Director of Aviation shall use reasonable efforts to reassign the space to another airline. No such reassignment, vacation, transference, conveyance, or sublease shall release Airline from its obligations under this Agreement including responsibility for payment of rent, utilities, fees and other charges, without specific written consent by City to such release. Airline shall be responsible for returning all relinquished space to the condition upon it was given, normal wear and tear accepted.

Section 11.03 Bankruptcy

Section 11.01 shall not apply to any valid assumption and/or assignment of this Agreement, the leased space, or any part thereof, by a trustee, or by Airline as a debtor in possession under the Bankruptcy Code of 1978, as amended, including the Bankruptcy Abuse Prevention and Consumer Protection Act of 2005 (collectively the "U. S. Bankruptcy Code"), provided that adequate assurance of future performance as provided by the U. S. Bankruptcy Code is to be provided, in writing, as a condition of the assumption and/or assignment of this Agreement. Such assurance shall include but shall not be limited to:

- A. Adequate assurance of the reliability of the proposed source for the rental, utilities, fees or other charges due under this Agreement upon the assumption and/or assignment of this Agreement;
- B. Adequate assurance that all other consideration due under this Agreement shall be forthcoming after the assumption or assignment of this Agreement and that any defaults thereunder shall be cured; and
- C. The procurement of a bond from a financially reputable surety covering any costs or damages which the City reasonably estimated the City would incur in the event that City, within three (3) years following the assumption and/or assignment of this Agreement, becomes entitled to and exercises any right to reassign the lease covered by this Agreement under this Agreement.

Section 11.04 Consent

Consent by City to any type of transfer provided for by this Article 11 shall not in any way be construed to relieve Airline from obtaining further consent for any subsequent transfer, assignment, and/or assumption of any nature whatsoever.

**ARTICLE 12: DEFAULTS**

Section 12.01 Default

If Airline and/or its Affiliates, and/or subsidiaries (1) fails to pay rent or any other payment past due hereunder within ten (10) calendar days after receipt of written notice of a past due account under Article 5 or elsewhere in this Agreement, or (2) fails to keep and perform any of its other covenants and agreements hereunder and such failure continues for thirty (30) calendar days after receipt of written notice of such failure, or (3) fails to continue to complete, in a timely manner, any of its covenants and agreements after performance is commenced, or after the filing of any petition, proceedings, or action by, for, or against Airline under any insolvency, bankruptcy, or reorganization act of law, then an event of default shall occur under this Agreement and, at the election of City:

- A. Without terminating this Agreement, City may reenter the Leased Premises and improve and relet all or any part of it to others, for the account of Airline, including costs of renovation necessitated by the neglect of Airline, its agents, or its employees and a reasonable administrative fee to City (in accordance with its cost

accounting procedures) for all costs incurred, (not to exceed fifteen percent 15% of such costs) for all sublease rentals received, and Airline shall promptly reimburse City for any deficiency in rentals or other payments received under such subletting, as compared to Airline's obligations hereunder. City shall use reasonable commercial efforts to sublet the Leased Premises.

- B. At any time before or after a reentry and reletting as provided in Article 12, City may terminate Airline's rights under this Agreement as provided in Article 13, without any restriction upon recovery by City for past due rentals and other obligations of Airline. City shall have all additional rights and remedies as may be provided to landlords by law.

### **ARTICLE 13: TERMINATION**

#### **Section 13.01 Conditions of Leased Premises at Termination**

Upon termination of this Agreement, Airline shall yield and deliver to City the Leased Premises promptly and in good repair and a clean, sanitary condition, and, if necessary, restored to the satisfaction of City to the condition it was given upon first use of occupancy by the Airline, reasonable wear and tear excepted.

#### **Section 13.02 Events Permitting Termination by City**

- A. City may terminate this Agreement upon ninety (90) calendar days' written notice and all of its obligations hereunder and may exercise all rights of entry and reentry upon the Leased Premises available under law, upon or after the occurrence of any one of the following events:

1. Airline and/or its Affiliates flying on behalf of Airline, and/or subsidiaries is in arrears in the payment of the whole or any part of the amounts agreed upon hereunder for a period of ten (10) days after Director of Aviation has notified Airline in writing that payment was not received when due;
2. Airline files in any court a petition in bankruptcy or insolvency or for the appointment of a receiver or trustee of all or a portion of Airline's property;
3. Airline makes any general assignment for the benefit of creditors;
4. Airline voluntarily abandons the Leased Premises for a period exceeding sixty (60) days;
5. Airline defaults in the performance of any of the covenants and conditions required herein (except rental payments) to be kept and performed by Airline, and such default continues for a period of thirty (30) days after receipt of written notice from Director of Aviation to cure such default;
6. Airline is adjudged a bankrupt in involuntary bankruptcy procedures;

7. Airline is made a party to any receivership proceeding in which a receiver is appointed for the property or affairs of Airline where such receivership is not vacated within sixty (60) days after the appointment of such receiver;
  8. The abolition, limitation, or restriction by any act of federal, state or local authority under which these Premises are being leased, except with respect to legislation that grants authority to a successor.
  9. Airline and/or its affiliates, and/or subsidiaries fails to comply with PFC requirements including those requirements set forth in this Agreement and such failure continues for ten (10) days after written notice from the Director of Aviation.
  10. Redevelopment of the Airport that necessitates relocation of Airline from Leased Premises.
- B. In any of the aforesaid events, City may take immediate possession of the Leased Premises in any lawful manner including any and all improvements thereon and remove Airline's effects.
- C. Failure of City to declare this Agreement terminated upon the default of Airline for any of the reasons set out shall not operate to bar or destroy the right of City to terminate this Agreement by reason of any subsequent violation of the terms of this Agreement.
- D. No receipt or acceptance of money by City from Airline after the expiration or termination of this Agreement, or after the service of any notice, or after the commencement of any suit, or after final judgment for possession of the Leased Premises, shall reinstate, continue, or extend the terms of this Agreement, or affect any such notice, demand or suit or imply consent for any action for which City's consent is required or operate as a waiver of any right or remedy of City including any right to lawfully retake and resume possession of the Leased Premises.

## **ARTICLE 14: GENERAL PROVISIONS**

### Section 14.01 Compliance with Law

- A. Airline shall not use the Leased Premises or any part thereof, or knowingly permit the same to be used by any of its employees, officers, agents, subtenants, invitees, or licensees for any illegal purposes and shall, at all times during the term of this Agreement, comply with all applicable ordinances and laws of any City, county, or state government or of the U.S. Government, and of any political division or subdivision or agency, City, or commission thereof which may have jurisdiction to pass laws or ordinances or to make and enforce rules or regulations with respect to the uses hereunder or the Leased Premises.

- B. At all times during the term of this Agreement, Airline shall, in connection with its activities and operations at the Airport:
1. Comply with and conform to all present and future statutes and ordinances, rules and regulations promulgated thereunder, of all federal, state, local and other governmental bodies of competent jurisdiction that apply in any manner to Airline or Airline's operations and activities under this Agreement. This includes but is not limited to the FAA Assurances as updated from time to time by the FAA in **Exhibit M**.
  2. In accordance with **Exhibit I** make, at its own expense, all nonstructural improvements, repairs, and alterations to its Exclusive Use Space (subject to prior written approval of City), equipment, and personal property that are required to comply with or conform to any such statutes and ordinances.
  3. Be and remain under this Agreement an independent contractor of City with respect to all installations, construction, and services performed by or on behalf of Airline hereunder, and otherwise.

Section 14.02 Notices

- A. Any notice under the terms of this Agreement shall be in writing and sent by certified mail, return receipt requested or by any nationally recognized overnight delivery service or delivered personally. The deemed date of any notice shall be the date the notice is received if personally served, the following business day if sent by recognized overnight delivery service, or 3 days following sufficient service by mail. If such notice is given by Airline, it shall be submitted to:

City of Fresno – Airports Department  
4995 East Clinton Way  
Fresno, CA 93727-1504  
Director of Aviation  
or to such revised address as notified by City

If such notice is given by City, it shall be submitted to:

Airport Affairs  
Southwest Airlines, Co.  
P.O. Box 36611, HDQ-4PF  
2702 Love Field Drive  
Dallas, TX 75235  
Phone: 214-792-4393

A party may change its notice address of record by written notice thereof given in the manner provided herein.

- B. If notice is given in any other manner or at any other place, it will also be given at the place and in the manner specified above.

Section 14.03 Successors and Assigns Bound

This Agreement shall be binding upon and inure to the benefit of the successors and assigns of the parties hereto.

Section 14.04 Governing Law, Venue and Attorney's Fees

- A. This Agreement and all disputes arising hereunder shall be governed by the laws of the State of California, and exclusive venue in any and all actions arising under this Agreement shall be laid in a state or Federal court located in the Judicial District of Fresno County, California.
- B. In any action or proceeding which City or Airline may be required to prosecute to enforce its respective rights under this Agreement, the unsuccessful party therein agrees to pay all costs incurred by the prevailing party therein, including reasonable interest and attorneys' fees, to be fixed by the court, and said costs, interest, and attorneys' fees shall be made a part of the judgment in said action.

Section 14.05 Subordination to Agreements with U.S. Government

This Agreement is subject and subordinate to the provisions of any agreements heretofore or hereinafter made between the City and the United States, relative to the operation or maintenance of the Airport, the execution of which has been required as a condition precedent to the transfer of federal rights or property to City for Airport purposes, or to the expenditure of federal funds for the improvement or development of the Airport, including the expenditure of federal funds for the development of the Airport in accordance with the provisions of the Federal Aviation Act of 1958, as it has been amended from time to time. City covenants that it has no existing agreements with the United States in conflict with the express provisions hereof.

Section 14.06 Nonwaiver of Rights

The non-enforcement by either party of the breach of any term, covenant or condition herein stipulated, shall never be construed to be a waiver of any other or succeeding breach of any term, covenant or condition herein imposed upon the other party. The acceptance of payments of any amounts due or to become due hereunder in any other way or manner, or at any other time than herein provided, shall never be construed as a waiver of the right of City of any of the provisions herein imposed upon Airline.

Section 14.07 Federal Aviation Act, Section 308

Nothing herein contained shall be deemed to grant to Airline any exclusive right or privilege within the meaning of Section 308 of the Federal Aviation Act, as amended or succeeded, for the conduct of any activity on the Airport, except that, subject to the terms

and provisions hereof, Airline shall have the right to exclusive possession of the Exclusive Use Space leased to Airline under the provisions of this Agreement.

Section 14.08 Severability

If one or more clauses, sections, or provisions of this Agreement shall be held to be unlawful, invalid, or unenforceable, it is agreed that the remainder of the Agreement shall not be affected thereby.

Section 14.09 Headings

The headings of the several articles and sections of this Agreement are inserted only as a matter of convenience and for reference and in no way define, limit, or describe the scope or intent of any provisions of this Agreement and shall not be construed to affect in any manner the terms and provisions hereof or the interpretation or construction thereof.

Section 14.10 Bad Checks

Any checks returned due to insufficient funds or for any other reason caused by Airline will incur a charge for handling, to be paid by Airline upon proper invoice. This charge will consist of all identifiable expenses with a minimum charge of twenty-five dollars (\$25.00) for each check not to exceed the maximum charge allowed by law.

Section 14.11 Assignment by City or Other Successor in Interest

City may assign or otherwise convey its interest, rights, duties, and/or obligations hereunder to any extent allowed by law. In this regard City or its assignee may assign, pledge, or take other appropriate action with respect to this Agreement and their rights and interests hereunder for any purpose relating to the issuance of bonds or other revenue generating devices.

Section 14.12 Authorization

Airline covenants that it is licensed and authorized to do business in the State of California.

Section 14.13 Removal of Disabled Aircraft

Following the authorization or clearance of federal aviation, law enforcement authorities and/or Airport Operations designee, Airline shall promptly remove any of its disabled aircraft from any part of the Airport (including, without limitation, runways, taxiways, aprons, and aircraft parking positions) and place any such disabled aircraft in such storage areas as may be designated by Director of Aviation. Airline may store such disabled aircraft only for such length of time and on such terms and conditions as may be established by Director of Aviation. If Airline fails to remove any of its disabled aircraft promptly, Director of Aviation may, but shall not be obligated to, cause the removal and storage of such disabled aircraft, provided, however, the obligation to remove or store



such disabled aircraft shall be consistent with federal laws and regulations, including those of the FAA and the National Transportation Safety Board (NTSB). Airline agrees to reimburse City for all reasonable costs of such removal and storage; and Airline, furthermore, hereby releases City from any and all claims for damage to the disabled aircraft or otherwise arising from or in any connected with such removal by City, except to the extent caused by the active negligence or willful misconduct of City, its agents, or its employees.

Section 14.14 Quiet Enjoyment

Except to any extent otherwise expressly provided in this Agreement, City covenants and agrees that Airline on paying the rent (and other charges herein provided for) and observing and keeping the covenants, conditions, and terms of this Agreement, shall lawfully and quietly hold, occupy and enjoy the Leased Premises during the term of this Agreement without hindrance or molestation by City or any person claiming under City.

Section 14.15 Force Majeure

No party to this Agreement is responsible to the other party for nonperformance or delay in performance of the terms and conditions herein due to acts of God, acts of government, wars, riots, strikes, acts of terrorism, accidents in transportation, fuel or material shortages, or other causes beyond the control of a party.

Section 14.16 Independent Contractor

Airline is and throughout this Agreement shall be an independent contractor and not an employee, partner or agent of the City. Neither party shall have any right to control, supervise or direct the manner or method or choice by which the other party or its contractors shall perform its or their work or function. However, each party shall retain the right to verify that the other is performing its respective obligations in accordance with the terms hereof.

Neither the Airline, nor any of its officers, associates, agents, or employees shall be deemed an employee of the City for any purpose. Airline shall not be entitled to nor shall it receive any benefit normally provided to employees of the City such as, but not limited to, vacation payment, retirement, health care, or sick pay. The City shall not be responsible for withholding income or other taxes from the payments made to Airline. Airline shall be solely responsible for filing all returns and paying any income, social security or other tax levied upon or determined with respect to the payments made to Airline pursuant to this Agreement.

Section 14.17 Partnership/Joint Venture

This Agreement does not evidence a partnership or joint venture between Airline and City. Except to any extent expressly provided for in this Agreement, (i) the City does not grant, convey, or delegate to Airline any tangible or intangible property interest or express or implied agency, license, right or authority, (ii) Airline shall have no authority to bind the

City absent its express written consent, (iii) either Party shall be free from obligations or liabilities under contracts entered by the other, and (iv) each Party shall bear its own costs/expenses in pursuit hereof.

Section 14.18 Compliance with ADA and Other Handicap Access and Nondiscrimination

Airline agrees that with respect to the Leased Premises including leased Aircraft Parking Areas and loading bridges, Airline shall be responsible, at Airline's cost, for compliance with the Americans with Disabilities Act of 1990 ("ADA", 42 U.S.C. 12101 et seq.) and the regulations and Accessibility Guidelines for Buildings and Facilities issued pursuant thereto; provided, however, in connection with the foregoing, Airline shall not be obligated to perform any alterations or undertake any construction in Common Use Space or any City-maintained loading bridges. Airline recognizes that the City is a public entity subject to Title II of the ADA. To the extent permitted by law, Airline shall assume and be obligated to comply with any obligations to which the City may be subject to under Title II of the ADA with respect to any programs, services, activities, alterations or construction conducted or undertaken by Airline at its premises. Airline shall also be responsible, at Airline's cost, for compliance with any applicable disabled accessibility laws, including, but not limited to, the Air Carriers Access Act ("ACAA", 49 U.S.C. 41705), and regulations implementing the ACAA.

A Certified Access Specialist (CASp) can inspect the subject premises and determine whether the subject premises comply with all of the applicable construction-related accessibility standards under state law. Although state law does not require a CASp inspection of the subject premises, the commercial property owner or lessor may not prohibit the Airline or tenant from obtaining a CASp inspection of the subject premises for the occupancy or potential occupancy of the Airline or tenant, if requested by the Airline or tenant. The parties shall mutually agree on the arrangements for the time and manner of the CASp inspection, the payment of the fee for the CASp inspection, and the cost of making any repairs necessary to correct violations of construction-related accessibility standards within the premises.

Section 14.19 Compliance with Environmental Laws

Airline shall, in conducting any activity or business at the Airport, including environmental responses or remedial activities, comply with all applicable Environmental Laws, including but not limited to Environmental Laws regarding the generation, storage, use, transportation and disposal of solid wastes, Hazardous Materials, or other contaminants and regarding releases or threatened releases of Hazardous Materials or other contaminants in the environment.

- A. Review of Environmental Documents. Airline, at the request of City, shall make available for the inspection and copying upon reasonable notice at a reasonable time, any or all of the documents and materials Airline has prepared pursuant to any applicable Environmental Law or submitted to any governmental regulatory agency pursuant to any Environmental Law; provided, that such documents and

materials are not protected from disclosure by a court order, any available self-audit privilege, attorney work product doctrine or attorney client privilege and are pertinent to Airline's rights and obligations under this Agreement at the Airport or to the Leased Premises. Such documents and materials released to the City shall be kept confidential to the fullest extent allowed by law. If any applicable Environmental Law requires Airline to file any notice or report of a release or threatened release of Hazardous Materials on, under or about the Leased Premises or the Airport, Airline shall provide a draft copy of such report or notice to the City to the extent practical given time constraints imposed by applicable Environmental Laws and Airline shall consult with City and give due consideration to the City's comments and concerns prior to submitting such notice or report to the appropriate governmental agency.

- B. Access of Environmental Inspection. On reasonable written notice and at a reasonable time, such to not disturb Airline's operations, City shall have access to the Leased Premises to inspect the same, with a representative of Airline to be present during such access and inspection, in order to confirm that the Airline is using the Leased Premises in accordance with applicable Environmental Laws. Airline, at the request of City and at City's expense, shall conduct such testing and analysis as is reasonable and necessary to ascertain whether Airline is using the Leased Premises in compliance with applicable Environmental Laws; provided that if the testing and analysis determines that Airline's use is not in compliance with applicable Environmental Laws, then Airline shall bear the reasonable cost of such testing and analysis. Any such tests shall be conducted by qualified independent experts chosen by Airline and subject to City's approval which approval will not be unreasonably withheld. Copies of reports from any such testing shall be provided to City upon receipt by Airline.
- C. Environmental Non-compliance. If, after reasonable notice to Airline and opportunity for Airline to commence measures to address compliance, Airline fails to comply with any applicable Environmental Laws, City, in addition to its rights and remedies provided at law or in equity, may lawfully enter the Leased Premises and take all reasonable and necessary measures, at Airline's expense, to insure compliance with applicable Environmental Laws.
- D. Duty to Notify City. In the event of a release or threatened release of Hazardous Material into the environment in violation of applicable Environmental Laws relating to or arising out of Airline's use or occupancy of the Leased Premises or in the event any claim, demand, action or notice is made against Airline regarding Airline's failure or alleged failure to comply with any applicable Environmental Laws at the Leased Premises, Airline promptly shall notify City by in writing within five (5) business days, followed by written notice and shall provide City with copies of any written claims, demands, notices, or actions so made.
- E. Environmental Remediation. Airline shall undertake such steps to remedy and remove releases of any Hazardous Materials resulting from the acts or omissions of Airline on or under the Leased Premises, as are necessary and reasonable to

protect the public health safety and the environment as required by applicable Environmental Laws. Such work shall be performed at Airline's sole expense after Airline submits to City a written plan for completing such work and receives the prior written approval of City which approval shall not be unreasonably withheld. City shall have the right to review and inspect all such work at any time using consultants and representatives of its choice at City's expense. Specific cleanup levels for any environmental remediation work shall be in compliance with all of the applicable Environmental Laws. To the extent that City is named in any enforcement action or lawsuit by any party in connection with a release of Hazardous Materials or noncompliance with Environmental Laws caused by Airline at the Leased Premises, Airline shall defend City and indemnify and hold harmless City and its officers, employees and agents from any costs, damages or fines resulting therefrom, except to the extent caused by City or a third party not contractually related to Airline or resulting from a condition existing prior to Airline's first occupancy of the Leased Premises.

Section 14.20 Covenant Not to Grant More Favorable Terms

City shall not enter into any lease, contract or other agreement with any other airline providing service at the Airport which contains any rates, charges, and/or terms more favorable to such airline than the rates and charges payable hereunder by the Airline or terms hereunder unless the City also makes those more favorable terms available to the Airline.

Section 14.21 Interpretation of Provisions

Nothing herein contained shall be construed or interpreted, in any manner whatsoever, as limiting, relinquishing or waiving any of the rights of ownership enjoyed by City in and to Airport property, or in any manner waiving or limiting City's control over the operation, maintenance, etc., of Airport property or in derogation of such governmental rights as City possesses, except as is specifically set forth herein.

Section 14.22 Interpretation of Agreement

The Parties acknowledge that this Agreement in its final form is the result of the combined efforts of the Parties and that, should any provision of this Agreement be found to be ambiguous in any way, such ambiguity shall not be resolved by construing this Agreement in favor or against any party, but rather by construing the terms in accordance with their generally accepted meaning.

Section 14.23 Cumulative Remedies

No remedy or election hereunder shall be deemed exclusive but shall, wherever possible, be cumulative with all other remedies at law or in equity.

Section 14.24 Non-Solicitation

Airline represents and warrants that it has not paid or agreed to pay any compensation, contingent or otherwise, to solicit or procure this Agreement or any rights/benefits hereunder.

Section 14.25 Precedence of Documents

In the event of any conflict between the body of this Agreement and any exhibit or attachment hereto, the terms and conditions of the body of this Agreement shall control and take precedence over the terms and conditions expressed within the exhibit or attachment. Furthermore, any terms or conditions contained within any exhibit or attachment hereto which purport to modify the allocation of risk between the parties, provided for within the body of this Agreement, shall be null and void.

Section 14.26 Entire Agreement

This Agreement, together with all exhibits, documents and instruments attached hereto and incorporated herein, constitutes the entire agreement between the parties hereto, and all other representations or statements heretofore made, verbal or written, are merged herein, and this Agreement may be amended only in writing, and executed by duly authorized representatives of the parties hereto.

**[Signatures on the following page]**

**ARTICLE 15: SIGNATURE**

**IN WITNESS WHEREOF**, City has caused this Agreement to be executed and issued by its Director of Aviation, and Airline, by the signature(s) of its duly authorized officer(s) hereunto below affixed, has accepted this Agreement and acknowledged and/or agreed to all of the terms, covenants, conditions, warranties, agreements, and provisions herein contained, as of the day and year first above written.

**CITY OF FRESNO, CALIFORNIA**  
A Municipal Corporation

**SOUTHWEST AIRLINES, CO.**  
A Texas Corporation

By: \_\_\_\_\_  
Henry Thompson, A.A.E., IAP  
Director of Aviation

DocuSigned by:  
Steve Sismeros 4/13/2022  
By: \_\_\_\_\_  
Marilyn Post (Printed Name)

APPROVED AS TO FORM:  
DOUGLAS T. SLOAN  
City Attorney

Title: Vice President - Airport Affairs  
(If corporation or LLC, Board  
Chair, Pres. or Vice Pres.)

DocuSigned by:  
By: Brandon Collet 5/2/2022  
Brandon M. Collet, Date  
Senior Deputy

DocuSigned by:  
By: Marilyn Post 4/19/2022  
Marilyn Post  
(Printed Name)

**ATTEST:**  
Todd Stermer, CMC  
City Clerk

Title:  
Secretary  
(If corporation or LLC, CFO,  
Treasurer, Secretary or Assistant  
Secretary)

By: \_\_\_\_\_  
Deputy city clerk

Address for Notice:  
City of Fresno  
Airports Department  
4995 E. Clinton Way  
Fresno, CA 93727

Address for Notice:  
Airport Affairs  
**Southwest Airlines, Co.**  
**P.O. Box 36611, HDQ-4PF**  
**27002 Love Field Drive**  
**Dallas, TX 75235**  
**Phone: 214-792-4393**

- Attachments:  
Exhibit A: Terminal Common Use Area  
Exhibit B: Leased Premises Terminal Building  
Exhibit C: Terminal Cost Center Map  
Exhibit D: Terminal Building Rental Rate  
Exhibit E: Airfield Area Cost Center Map  
Exhibit F: Airfield Area Rate (Landing Fee)  
Exhibit G: FIS Fee Rate

- Exhibit H: Signatory Credit
- Exhibit I: Operation and Maintenance Responsibilities
- Exhibit J: Affiliates, Subsidiaries and Code Share Partners
- Exhibit K: Monthly Operations Report
- Exhibit L: Conflict of Interest Form
- Exhibit M: FAA Grant Assurances
- Exhibit N: Federal Provision Applicable to All Agreements

# **EXHIBIT A**



REVISIONS/REFERENCE		
REV. NO.	DATE	DESCRIPTION

AIRPORTS DEPARTMENT  
 FRESNO YOSEMITE INTERNATIONAL AIRPORT  
 TERMINAL ROOM MAP  
 2021

DIRECTOR OF AVIATION  
KEVIN R. MEKLE, ARCHITECT

PROJECT MGR. \_\_\_\_\_ RLM  
 CONST. MGR. \_\_\_\_\_ LG  
 PLANNING MGR. \_\_\_\_\_ MWD

PROJECT I.D. AC-----

DRAWN BY: \_\_\_\_\_ NRC

CHECKED BY: \_\_\_\_\_

DATE: 09/24/2021

SCALE: VARIES

SHEET NO.

1  
OF 1 SHEETS

COMMON SPACE (46,901 Sq. Ft.)

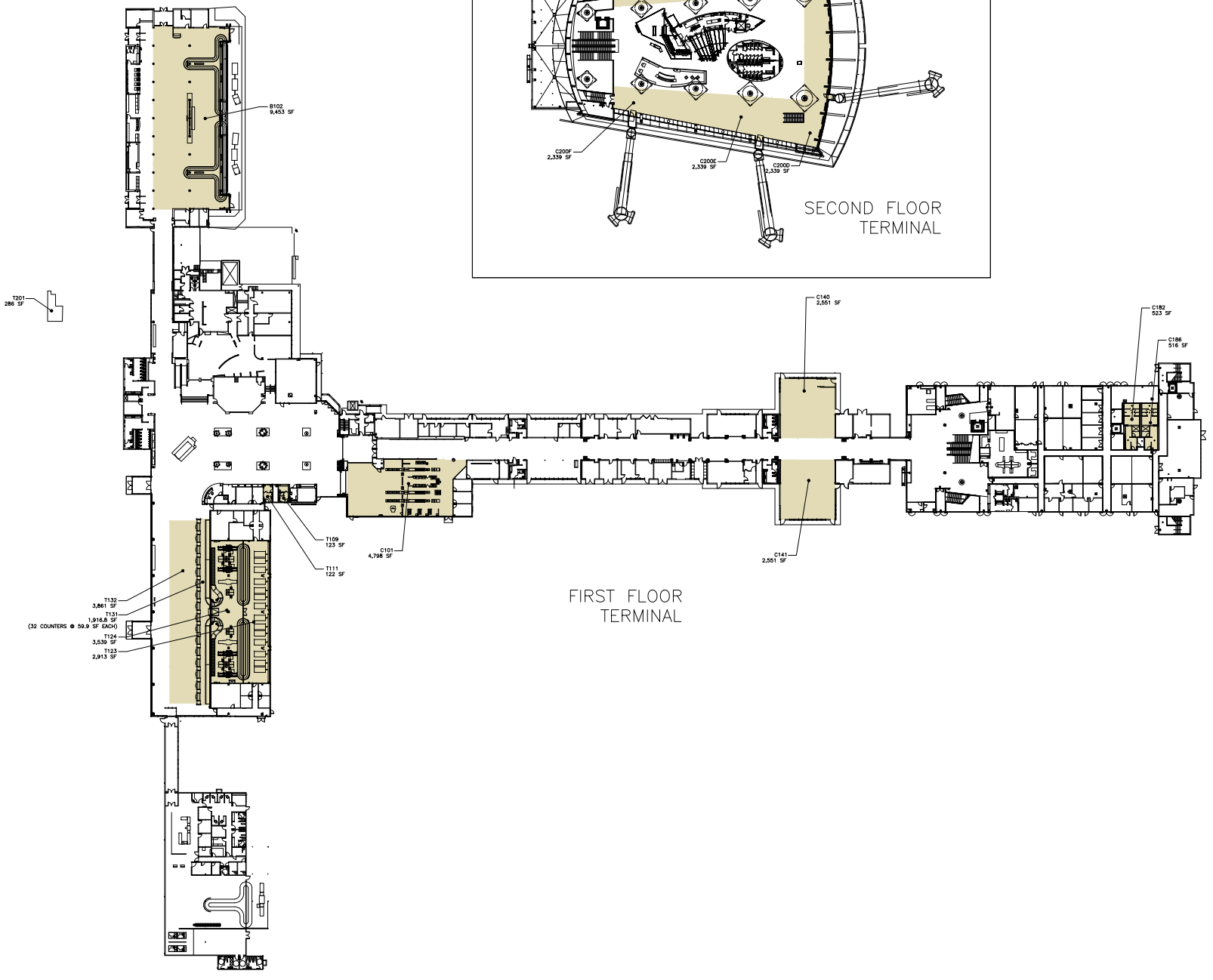
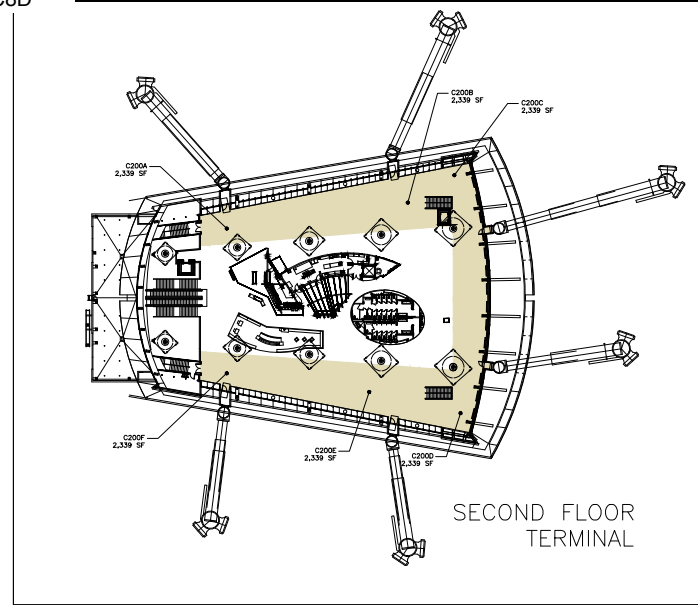

T201  
286 SF

T102  
8,453 SF

T132  
3,861 SF  
 T131  
1,916.8 SF  
 (32 COUNTERS @ 59.9 SF EACH)  
 T129  
3,539 SF  
 T123  
2,913 SF

T109  
123 SF

T111  
122 SF

C101  
4,798 SF

C140  
2,551 SF

C141  
2,551 SF

C182  
523 SF

C186  
316 SF

C200A  
2,339 SF

C200B  
2,339 SF

C200C  
2,339 SF

C200F  
2,339 SF

C200G  
2,339 SF

C200H  
2,339 SF



CITY OF FRESNO  
AIRPORTS DEPARTMENT  
4995 EAST CLINTON WAY  
FRESNO, CALIFORNIA 93727  
PHONE: 559-621-4500

CONSULTANT INFORMATION

COMMON SPACE (2,257 Sq. Ft.)

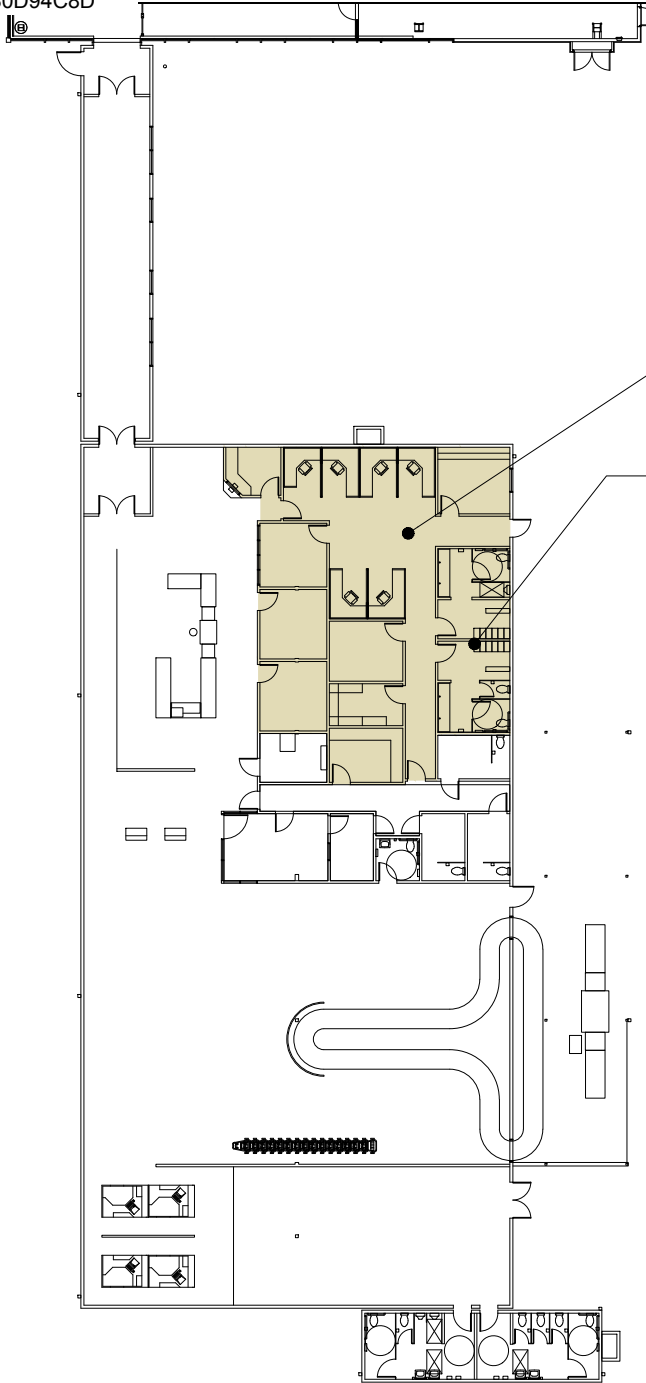

FIS4  
1,890 SF

FIS BR3  
367 SF

REVISIONS/REFERENCE

REV NO.	DATE	DESCRIPTION

AIRPORTS DEPARTMENT  
 FRESNO YOSEMITE INTERNATIONAL AIRPORT  
 TERMINAL ROOM MAP  
 2021

DIRECTOR OF AVIATION  
KEVIN R. MEKLE, ARCHITECT

PROJECT MGR. RLM  
CONST. MGR. LG  
PLANNING MGR. MWD

PROJECT I.D. AC-----

DRAWN BY: NRC

CHECKED BY: ---

DATE: 09/24/2021

SCALE: VARIES

SHEET NO.

1

OF 1 SHEETS

# **EXHIBIT B**

B101B  
233 SF

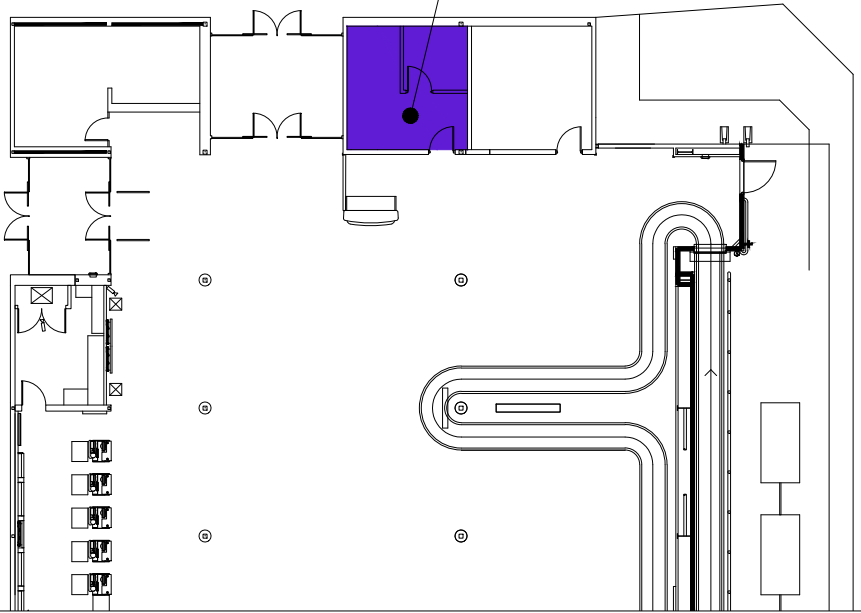

SOUTHWEST (1,217 Sq. Ft.)

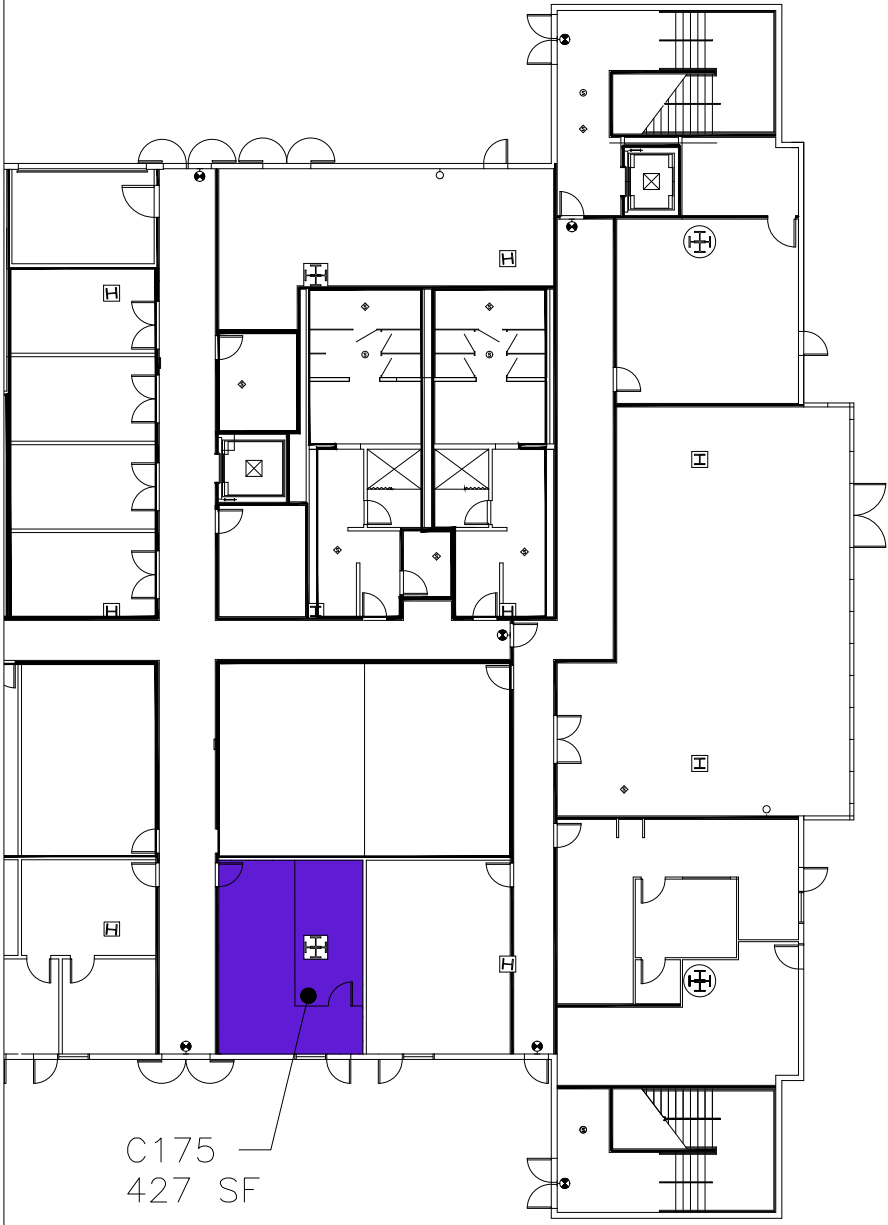

T114  
149 SF

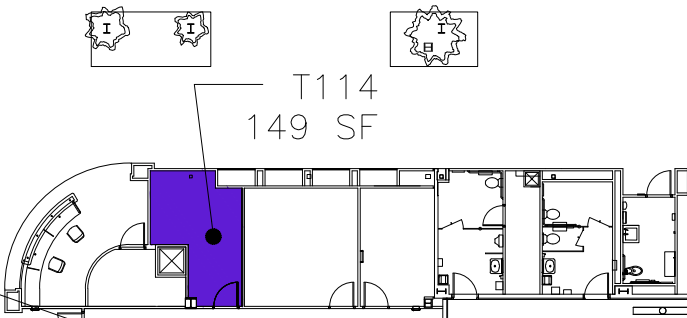

T119  
102 SF

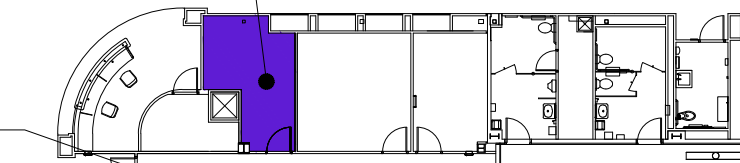

T120  
306 SF

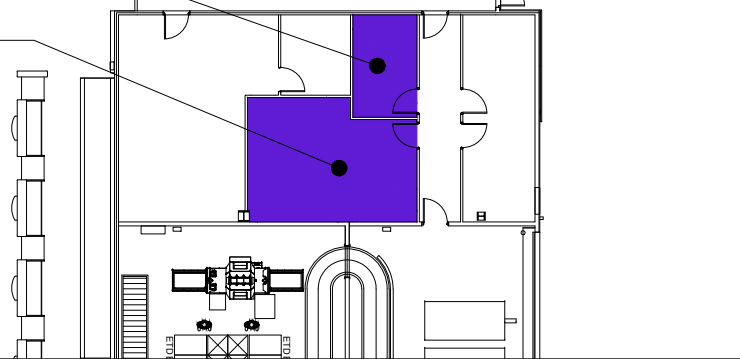

C175  
427 SF



CITY OF FRESNO  
AIRPORTS DEPARTMENT  
4995 EAST CLINTON WAY  
FRESNO, CALIFORNIA 93727  
PHONE: 559-621-4500

CONSULTANT INFORMATION

REVISIONS/REFERENCE

REV. NO.	DATE	DESCRIPTION

AIRPORTS DEPARTMENT  
 FRESNO YOSEMITE INTERNATIONAL AIRPORT  
 TERMINAL ROOM MAP  
 2021

DIRECTOR OF AVIATION  
KEVIN R. MEKLE, ARCHITECT

PROJECT MGR. \_\_\_\_\_ RLM  
 CONST. MGR. \_\_\_\_\_ LG  
 PLANNING MGR. \_\_\_\_\_ MWD

PROJECT I.D. AC-----

DRAWN BY: \_\_\_\_\_ NRC  
 CHECKED BY: \_\_\_\_\_  
 DATE: 09/24/2021  
 SCALE: VARIES

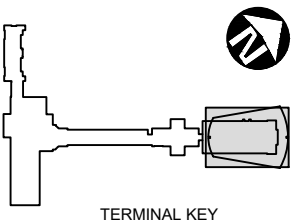
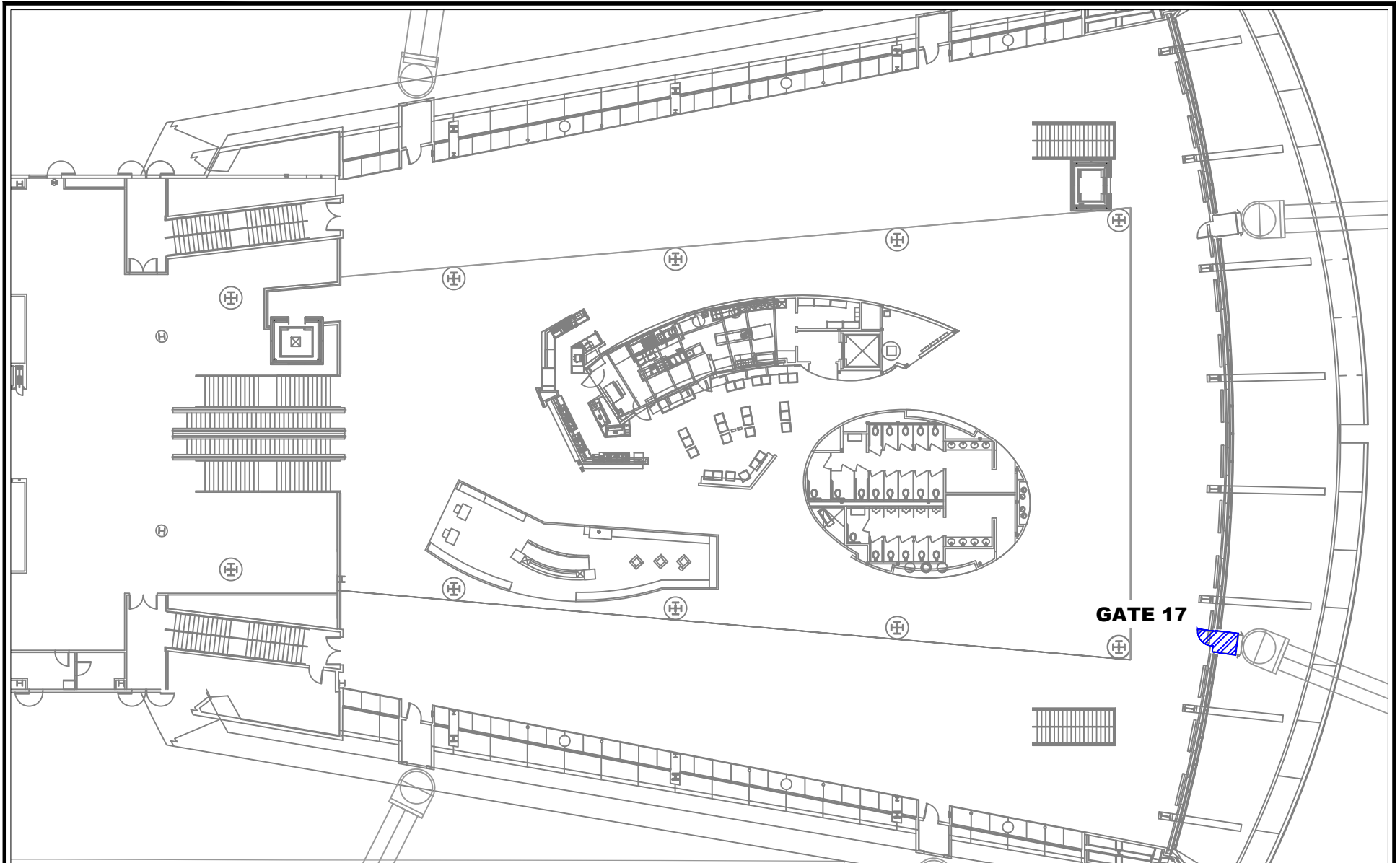

AIRPORTS  
DEPARTMENT

DIRECTOR OF AVIATION  
KEVIN R. MEIKLE, ARCHITECT

 **FRESNO YOSEMITE**  
INTERNATIONAL AIRPORT

CITY OF FRESNO  
AIRPORTS DEPARTMENT  
4995 EAST CLINTON WAY  
FRESNO, CALIFORNIA 93727  
PHONE: 559-621-4500

FRESNO YOSEMITE INTERNATIONAL AIRPORT

SECOND FLOOR TERMINAL  
GATE 17

KRA NO. \_\_\_\_\_  
FUND NO. \_\_\_\_\_  
ORG NO. \_\_\_\_\_  
ACTIVITY \_\_\_\_\_  
PROJECT I.D. \_\_\_\_\_

REVISIONS/REFERENCE  
REF NO.

APPROVED  
CONST. ENG. \_\_\_\_\_ OFFICE ENG. \_\_\_\_\_  
CITY DESIGN ENG. \_\_\_\_\_

DR. BY: LNS  
CH. BY: MGP  
DATE: 3-7-22  
SCALE: N/A

CITY DRAWING NO. XX-X-XXX  
SHEET NO. **1**  
OF 2 SHEETS

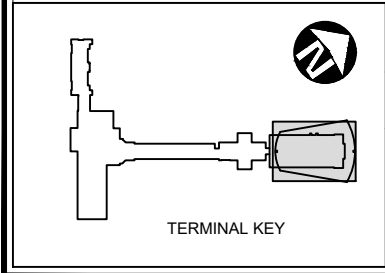
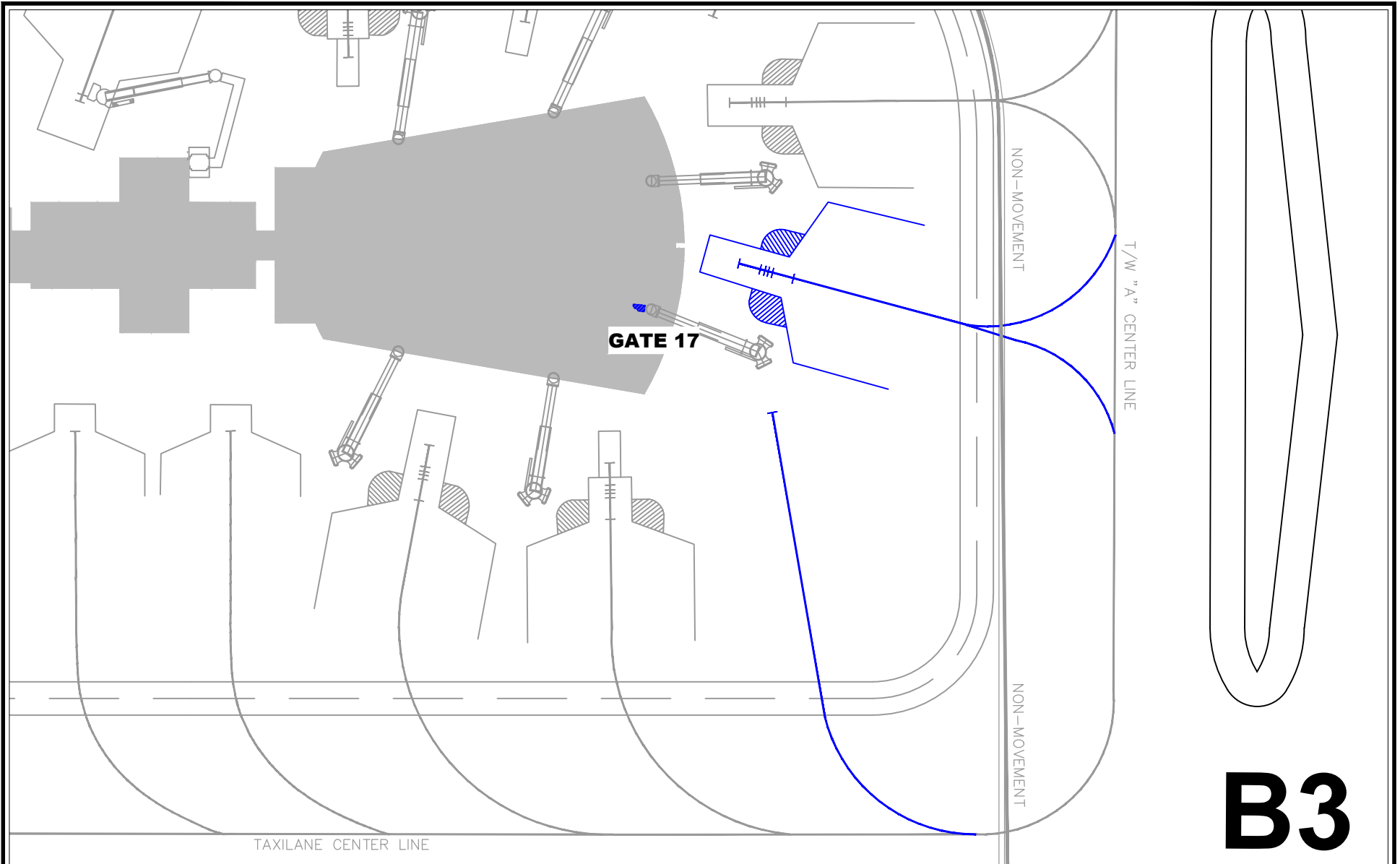

**AIRPORTS DEPARTMENT**  
 DIRECTOR OF AVIATION  
 KEVIN R. MEIKLE, ARCHITECT

**FRESNO YOSEMITE INTERNATIONAL AIRPORT**  
 CITY OF FRESNO  
 AIRPORTS DEPARTMENT  
 4995 EAST CLINTON WAY  
 FRESNO, CALIFORNIA 93727  
 PHONE: 559-621-4500

**FRESNO YOSEMITE INTERNATIONAL AIRPORT**

**SECOND FLOOR TERMINAL  
 GATE 17**

KRA NO. \_\_\_\_\_  
 FUND NO. \_\_\_\_\_  
 ORG NO. \_\_\_\_\_  
 ACTIVITY \_\_\_\_\_  
 PROJECT I.D. \_\_\_\_\_

CONST. ENG. \_\_\_\_\_  
 CITY DESIGN ENG. \_\_\_\_\_

DR. BY: LNS  
 CH. BY: MGP  
 DATE: 3-7-22  
 SCALE: N/A

REVISIONS/REFERENCE  
 REF NO.

**APPROVED**  
 OFFICE ENG. \_\_\_\_\_





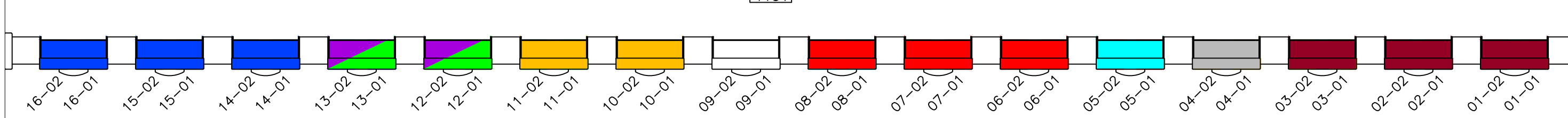
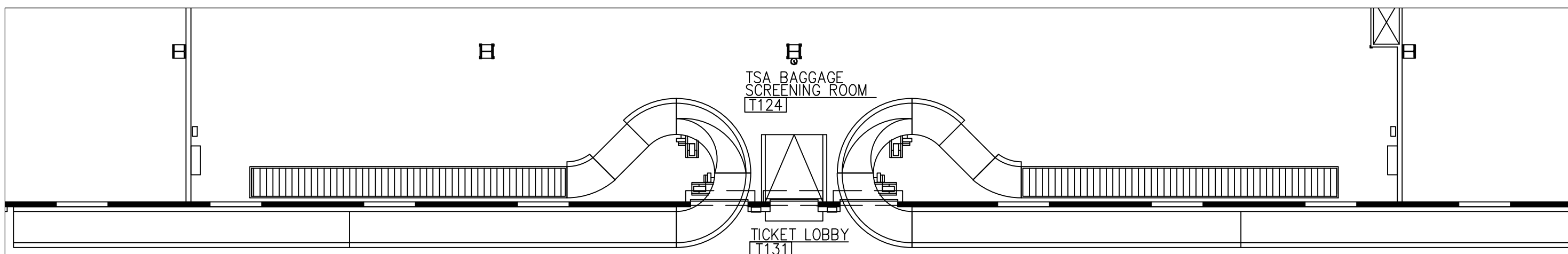

CITY DRAWING NO. XX-X-XXX  
 SHEET NO. 2  
 OF 2 SHEETS

CONSULTANT INFORMATION

REV. NO.	DATE	DESCRIPTION
REV 1	1-28-09	25-AA-368



TICKET LOBBY  
T100

	UNITED/ DELTA		ALLEGIANT
	VOLARIS/ FRONTIER		AEROMEXICO
	AMERICAN		ALASKA
			SOUTHWEST

**AIRPORTS DEPARTMENT**  
FRESNO YOSEMITE INTERNATIONAL AIRPORT  
AIRLINE TICKETING LOBBY

DIRECTOR  
OF AVIATION  
KEVIN R. MEIKLE, ARCHITECT

APPROVED

CONST. ENG.  
OFFICE ENG.  
CITY DESIGN ENG.

KRA # 0102002000

FUND #

ORG #

ACTIVITY

PROJECT I.D.

DRAWN BY: NRC

CHECKED BY: MGP

DATE: 01-06-2009

SCALE: 3/32" = 1'

FILE:

CITY DRAWING NO.  
25-AA-368

SHEET NO.  
**1**  
OF 1 SHEETS

J:\ARCHIVE\25AA\25AA00368(2).dwg

# **EXHIBIT C**



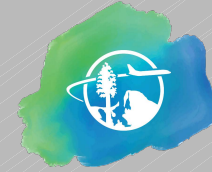

FRESNO YOSEMITE  
International Airport

Legend





-  Airfield
-  Terminal Building
-  FIS Facility
-  Non Airline

Exhibit C  
Terminal Building and FIS Facility  
Cost Centers



\*Note: Reflects Terminal Expansion Project Including FIS Facility

# **EXHIBIT D**

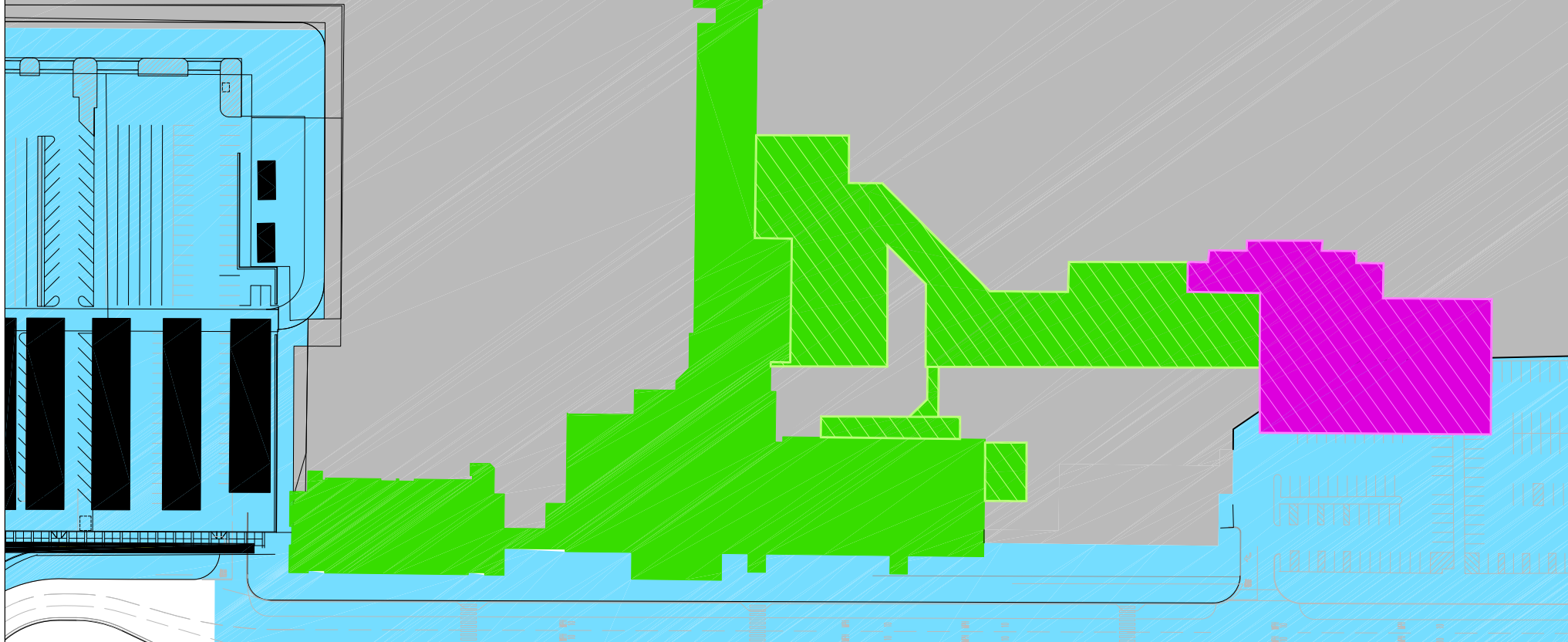
## Exhibit D

### Illustration of Annual Terminal Building Rental Rate Calculation Fresno Yosemite International Airport

		FY 2023 Illustration
<b>Amounts Allocable to Terminal Building Cost Center</b>		
Debt Service	[A]	\$ 765,486
Rolling Debt Service Coverage	[B]	-
Amortization Charges	[C]	256,468
Operating Expenses	[D]	13,747,485
Deposit to the Operating Reserve Fund	[E]	130,928
Terminal Building Credit	[F]	<u>(4,488,286)</u>
Terminal Building Net Requirement	[G]= Sum of [A] thru [E] -[F]	\$ 10,412,082
Usable Space	[H]	140,704
Rate Before Adjustment	[I]=[G]/[H]	\$ 74.00
Rate Adjustment due to Annual True-up	[J]	<u>-</u>
Terminal Building Rental Rate	[K]=[I]-[J]	\$ 74.00
Leased Premises	[L]	53,564
Airline Terminal Building Net Requirement	[K]*[L]	<u>\$ 3,963,721</u>

# **EXHIBIT E**



FRESNO YOSEMITE International Airport

# Exhibit E Airfield Area Cost Center

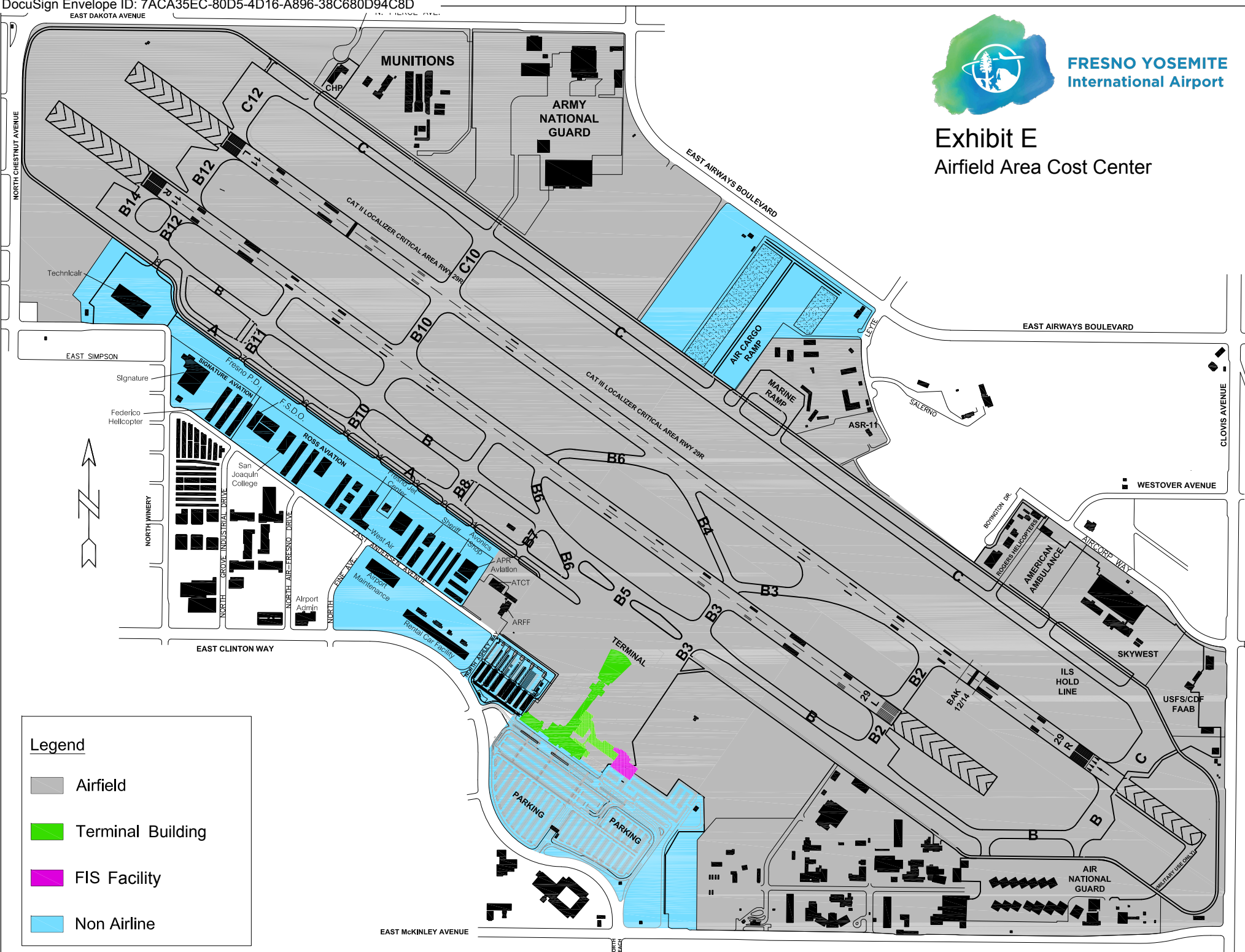

**Legend**

- Airfield
- Terminal Building
- FIS Facility
- Non Airline

\*Note: Reflects Terminal Expansion Project Including FIS Facility

# **EXHIBIT F**

**Exhibit F****Illustration of Annual Landing Fee Rate Calculation  
Fresno Yosemite International Airport**

		<b>FY 2023 Illustration</b>
<b>Amounts Allocable to Airfield Cost Center</b>		
Debt Service	[A]	\$ 9,856
Rolling Debt Service Coverage	[B]	-
Amortization Charges	[C]	75,000
Operating Expenses	[D]	6,921,484
Deposit to the Operating Reserve Fund	[E]	65,919
Airfield Area Credit	[F]	(2,712,502)
Annual True-up	[G]	164,704
Airline Airfield Area Net Requirement	[H]= Sum of [A] thru [E] -[F]-[G]	\$ 4,524,461
Landed Weight	[I]	1,657,757
Landing Fee Rate	[H]/[I]	\$ 2.73

# **EXHIBIT G**



**Exhibit G****Illustration of FIS Fee Rate Calculation  
Fresno Yosemite International Airport**

		<b>FY 2023 Illustration</b>
<b>Amounts Allocable to FIS Cost Center</b>		
Debt Service	[A]	\$ 120,911
Rolling Debt Service Coverage	[B]	-
Amortization Charges	[C]	-
Operating Expenses	[D]	2,226,760
Deposit to the Operating Reserve Fund	[E]	21,207
Applicable credits	[F]	<u>(500,976)</u>
Airline FIS Net Requirement	[G]= Sum of [A] thru [E] -[F]	\$ 1,746,991
FIS Users	[H]	179,743
FIS Fee Rate	[I]=[G]/[H]	\$ 9.72
Maximum FIS Fee Rate	[J]	12.00
FIS Fee Rate to Charge	Lower of [I] and [J]	\$ 9.72

**EXHIBIT H**

## Exhibit H

**Illustration of Annual Signatory Credit Calculation  
Fresno Yosemite International Airport**

		<b>FY 2023 Illustration</b>
Revenues	[A]	\$ 43,604,010
Debt Service	[B]	(4,862,988)
Rolling Debt Service Coverage	[C]	-
Operating Expenses	[D]	(26,669,055)
Deposit to Operating Reserve Fund	[E]	(253,991)
Capital Allowance	[F]	(4,000,000)
Remaining Revenues	[G]=[A]-SUM OF [B] Thru [F]	\$ 7,817,976
Share of Sig. Passenger and Sig. Cargo Carriers (a)	[H]=50%	50.0%
Signatory Credit	[I]=[G]*[H]	\$ 3,908,988
Amounts to Be Applied to FY 2024 (a)	[J]	\$ 2,000,000
Terminal Building Cost Center	[J]*65%	1,300,000
Airfield Area Cost Center	[J]*25%	500,000
FIS Cost Center	[J]*10%	200,000

Note: subject to further constraints in Section 5.12.

# **EXHIBIT I**

# Exhibit I

## OPERATIONS AND MAINTENANCE RESPONSIBILITIES FRESNO YOSEMITE INTERNATIONAL AIRPORT

Item	Exclusive Use and Shared Use	Common Use	Hold Rooms	Aircraft Parking Areas
1. Air conditioning a. Maintenance b. Operation	FYI FYI	FYI FYI	FYI FYI	FYI FYI
2. Heating a. Maintenance b. Operation	FYI FYI	FYI FYI	FYI FYI	FYI FYI
3. Lighting a. Maintenance b. Bulb replacement	Airline Airline	FYI FYI	FYI FYI	FYI FYI
4. Electrical a. Maintenance b. Usage	FYI (a) Airline	FYI FYI, Airline (b)	FYI FYI	FYI FYI, Airline (b)
5. Water a. Operation b. Distribution c. Fixtures d. Usage	FYI FYI FYI Airline	FYI FYI FYI FYI	FYI FYI FYI FYI	FYI FYI FYI FYI
6. Sewage a. Operation b. Distribution c. Fixtures d. Usage	FYI FYI FYI Airline	FYI FYI FYI FYI	FYI FYI FYI FYI	FYI FYI FYI FYI
7. Restrooms a. Maintenance b. Janitorial	FYI Airline	FYI FYI	FYI FYI	FYI FYI
8. Building maintenance a. Structural b. Non-Structural c. Exterior	FYI Airline FYI	FYI FYI FYI	FYI FYI FYI	FYI FYI FYI
9. Ramp a. Sweeping b. Maintenance/Repair	N/A N/A	N/A N/A	N/A N/A	Airline (c) FYI

Item	Exclusive Use and Shared Use	Common Use	Hold Rooms	Aircraft Parking Areas
10. Custodial/Trash	Airline	FYI	FYI	Airline
11. Window cleaning				
a. Exterior	FYI	FYI	FYI	FYI
b. <sup>1</sup> Interior	Airline	FYI	FYI	FYI
12. Access Control	Airline, FYI	FYI	N/A	FYI
13. Equipment				
a. Signage	Airline	FYI	FYI, Airline (d)	N/A
b. MUFIDs	N/A	FYI	FYI	N/A
c. Loading Bridges	N/A	FYI	N/A	FYI
d. Baggage Belts	N/A	FYI	FYI	FYI
e. Outgoing baggage	N/A	N/A	FYI	FYI
f. CUTE Systems	N/A	FYI	FYI	FYI
14. Painting/decorating				
a. Exterior	FYI	FYI	FYI	N/A
b. Interior	Airline	FYI	FYI	N/A
c. Ceiling	Airline	FYI	FYI	N/A

- 
- (a) Airline is responsible for any electrical fixtures or services installed by Airline.
- (b) Electrical usage consists of ground power for aircraft. Airline is responsible for any electrical fixtures or services installed by Airline.
- (c) Airline is responsible for cleaning debris on ramp from terminal building to a point 20 feet beyond the tail of the aircraft. City maintains the runway, taxiways, and balance of the ramp on the airfield area.
- (d) Airline must apply for and receive approval from City prior to any sign installation.

Note: All areas not part of Airline's leased premises will be City's responsibility; however, City will not be responsible for any systems or services installed by Airline unless otherwise agreed to by the parties in writing prior to installation.

# **EXHIBIT J**



FRESNO YOSEMITE  
International Airport

Listing of Airlines Affiliates, Subsidiaries, and Code Share Partners:

Airline Name: Southwest Airlines Co.

1. NA

NA

2. NA

NA

3. NA

NA

4. \_\_\_\_\_

\_\_\_\_\_

5. \_\_\_\_\_

\_\_\_\_\_



# **EXHIBIT K**

## FRESNO YOSEMITE INTERNATIONAL - SIGNATORY AIRLINES MONTHLY OPERATIONS REPORT

AIRLINE NAME: <input style="width: 95%;" type="text"/>	For Period: <input style="width: 45%;" type="text"/> , <input style="width: 45%;" type="text"/>
	(Month) (Year)

SECTION A: STATISTICAL INFORMATION	(1) - ENPLANED	(2) - DEPLANED	(3) - TOTAL
1 Passengers (Scheduled)	<input type="text"/>	<input type="text"/>	<input type="text"/>
2 Passengers (On-Line Charters)	<input type="text"/>	<input type="text"/>	<input type="text"/>
3 Passengers (NON-REV)	<input type="text"/>	<input type="text"/>	<input type="text"/>
Total Passengers	<input type="text"/>	<input type="text"/>	<input type="text"/>
4 Air Mail (In Pounds)	<input type="text"/>	<input type="text"/>	<input type="text"/>
5 Air Freight/Express (In Pounds)	<input type="text"/>	<input type="text"/>	<input type="text"/>

SECTION B: LANDING INFORMATION - SCHEDULED FLIGHTS						
	Type Aircraft Flown (Make/Model/Series)	# PAX Ft. Landings	MCGL Wt. of Aircraft	Total Aircraft Wt.	Rate per 1,000 lbs.	Landing Fees Due
1	<input type="text"/>	<input type="text"/>	<input type="text"/>	- x	\$2.93/1,000=	\$ -
2	<input type="text"/>	<input type="text"/>	<input type="text"/>	- x	\$2.93/1,000=	\$ -
3	<input type="text"/>	<input type="text"/>	<input type="text"/>	- x	\$2.93/1,000=	\$ -
4	<input type="text"/>	<input type="text"/>	<input type="text"/>	- x	\$2.93/1,000=	\$ -
5	<input type="text"/>	<input type="text"/>	<input type="text"/>	- x	\$2.93/1,000=	\$ -
6	<input type="text"/>	<input type="text"/>	<input type="text"/>	- x	\$2.93/1,000=	\$ -
<b>Total :</b>		<u>0</u>	<u>-</u>	<u>-</u>	<b>Total:</b>	<u>\$ -</u>

**Landing Fees Due:** If the minimum fee exceeds calculated fee for an individual aircraft type. Pay the minimum fee

SECTION C: LANDING INFORMATION - TRAINING FLIGHTS						
	Type Aircraft Flown (Make/Model/Series)	Total Landings	MCGL Wt. of Aircraft	Total Aircraft Wt.	Rate per 1,000 lbs.	Landing Fees Due
1	<input type="text"/>	<input type="text"/>	<input type="text"/>	0 x	\$1.18/1,000=	\$ -
2	<input type="text"/>	<input type="text"/>	<input type="text"/>	0 x	\$1.18/1,000=	\$ -
3	<input type="text"/>	<input type="text"/>	<input type="text"/>	0 x	\$1.18/1,000=	\$ -
<b>Total :</b>		<u>0</u>	<u>-</u>	<u>-</u>	<b>Total:</b>	<u>\$ -</u>

SECTION D: STORAGE/RON FEES - APPLICABLE TO AIRCRAFT PARKED IN EXCESS OF 4 HOURS									
	Type Aircraft Stored (Make/Model/Series)	Rate D/M	Actual # Days Stored	# of Days Used for Calculation (10+ - Enter 10)	MCGL Wt. of Aircraft	Rate per 1,000 lbs.	Calculated Storage Fees	Min. Fee \$24.48/Day \$244.80/Mo	Storage Fees Due
1	<input type="text"/>	<input type="text"/>	<input type="text"/>	<input type="text"/>	<input type="text"/>	<input type="text"/>	<input type="text"/>	<input type="text"/>	<input type="text"/>
								<b>Total:</b>	<u>\$ -</u>

**Rates:** Daily (D) = 4-24 Hours, Monthly (M) = 10+ Days  
**Storage Fees Due:** If the minimum fee (\$24.48/day, \$244.80/month) exceeds the calculated fee for an individual aircraft type, pay the minimum fee.

SECTION E: AIRPORT SECURITY REIMBURSEMENT		
Number of Scheduled Passengers Enplaned	Rate Per Enplanement	Total Security Reimbursement
-	x \$ 1.00 =	\$ -

SUMMARY OF FEES DUE		This Report Prepared and Submitted By:	
Total Due Section B	: \$ -	<input style="width: 95%;" type="text"/>	<input style="width: 95%;" type="text"/>
Total Due Section C	: \$ -		
Total Due Section D	: \$ -		
Total Due Section E	: \$ -		
<b>Total Fees Due</b>	<b>: \$ -</b>	<input style="width: 95%;" type="text"/>	<input style="width: 95%;" type="text"/>
		(Date)	(Area Code and Phone Number)

SUBMIT REPORT BY THE 10TH DAY OF MONTH, FOR THE PRIOR MONTH REPORT MUST BE COMPLETE AND SIGNED

PLEASE MAKE CHECK PAYABLE TO THE CITY OF FRESNO, AND REMIT WITH THIS REPORT TO: City of Fresno - Airports 4995 East Clinton Way, Fresno, CA 93727-1525

MCGL Wt. = Maximum Gross Certificated Landing Weight

**EXHIBIT L**

**Exhibit L  
DISCLOSURE OF CONFLICT OF INTEREST**

Airport Use and Lease Agreement between City of Fresno ("Fresno")  
and Southwest Airlines, Co. (" Southwest ")

		YES*	NO
1	Are you currently in litigation with the City of Fresno or any of its agents?	<input type="checkbox"/>	<input checked="" type="checkbox"/>
2	Do you represent any firm, organization or person who is in litigation with the City of Fresno?	<input type="checkbox"/>	<input checked="" type="checkbox"/>
3	Do you currently represent or perform work for any clients who do business with the City of Fresno?	<input type="checkbox"/>	<input checked="" type="checkbox"/>
4	Are you or any of your principals, managers or professionals, owners or investors in a business which does business with the City of Fresno, or in a business which is in litigation with the City of Fresno?	<input type="checkbox"/>	<input checked="" type="checkbox"/>
5	Are you or any of your principals, managers or professionals, related by blood or marriage to any City of Fresno employee who has any significant role in the subject matter of this service?	<input type="checkbox"/>	<input checked="" type="checkbox"/>
6	Do you or any of your subcontractors have, or expect to have, any interest, direct or indirect, in any other contract in connection with this Project?	<input type="checkbox"/>	<input checked="" type="checkbox"/>
* If the answer to any question is yes, please explain in full below.			

Explanation: \_\_\_\_\_  
NA

\_\_\_\_\_  
\_\_\_\_\_  
\_\_\_\_\_  
\_\_\_\_\_  
\_\_\_\_\_

Additional page(s) attached.

DocuSigned by:  
*Steve Sisneros*  
\_\_\_\_\_  
Signature  
3BFCB834DDBE4A5...

\_\_\_\_\_  
4/13/2022  
Date

\_\_\_\_\_  
Steve SISneros  
(name)

\_\_\_\_\_  
Southwest Airlines Co.  
(company)

\_\_\_\_\_  
2702 Love Field Drive  
(address)

\_\_\_\_\_  
Dallas, TX 75235  
(city state zip)

# **EXHIBIT M**



**FAA  
Airports**

## **ASSURANCES AIRPORT SPONSORS**

---

### **A. General.**

1. These assurances shall be complied with in the performance of grant agreements for airport development, airport planning, and noise compatibility program grants for airport sponsors.
2. These assurances are required to be submitted as part of the project application by sponsors requesting funds under the provisions of Title 49, U.S.C., subtitle VII, as amended. As used herein, the term "public agency sponsor" means a public agency with control of a public-use airport; the term "private sponsor" means a private owner of a public-use airport; and the term "sponsor" includes both public agency sponsors and private sponsors.
3. Upon acceptance of this grant offer by the sponsor, these assurances are incorporated in and become part of this grant agreement.

### **B. Duration and Applicability.**

#### **1. Airport development or Noise Compatibility Program Projects Undertaken by a Public Agency Sponsor.**

The terms, conditions and assurances of this grant agreement shall remain in full force and effect throughout the useful life of the facilities developed or equipment acquired for an airport development or noise compatibility program project, or throughout the useful life of the project items installed within a facility under a noise compatibility program project, but in any event not to exceed twenty (20) years from the date of acceptance of a grant offer of Federal funds for the project. However, there shall be no limit on the duration of the assurances regarding Exclusive Rights and Airport Revenue so long as the airport is used as an airport. There shall be no limit on the duration of the terms, conditions, and assurances with respect to real property acquired with federal funds. Furthermore, the duration of the Civil Rights assurance shall be specified in the assurances.

#### **2. Airport Development or Noise Compatibility Projects Undertaken by a Private Sponsor.**

The preceding paragraph 1 also applies to a private sponsor except that the useful life of project items installed within a facility or the useful life of the facilities developed or equipment acquired under an airport development or noise compatibility program project shall be no less than ten (10) years from the date of acceptance of Federal aid for the project.

#### **3. Airport Planning Undertaken by a Sponsor.**

Unless otherwise specified in this grant agreement, only Assurances 1, 2, 3, 5, 6, 13, 18, 25, 30, 32, 33, and 34 in Section C apply to planning projects. The terms, conditions, and assurances of this grant agreement shall remain in full force and effect during the life of the project; there shall be no limit on the duration of the assurances regarding Exclusive Rights and Airport Revenue so long as the airport is used as an airport.

### C. Sponsor Certification.

The sponsor hereby assures and certifies, with respect to this grant that:

#### 1. General Federal Requirements.

It will comply with all applicable Federal laws, regulations, executive orders, policies, guidelines, and requirements as they relate to the application, acceptance and use of Federal funds for this project including but not limited to the following:

- a. Title 49, U.S.C., subtitle VII, as amended.
- b. Davis-Bacon Act - 40 U.S.C. 276(a), et seq.<sup>1</sup>
- c. Federal Fair Labor Standards Act - 29 U.S.C. 201, et seq.
- d. Hatch Act – 5 U.S.C. 1501, et seq.<sup>2</sup>
- e. Uniform Relocation Assistance and Real Property Acquisition Policies Act of 1970 Title 42 U.S.C. 4601, et seq.<sup>1,2</sup>
- f. National Historic Preservation Act of 1966 - Section 106 - 16 U.S.C. 470(f).<sup>1</sup>
- g. Archeological and Historic Preservation Act of 1974 - 16 U.S.C. 469 through 469c.<sup>1</sup>
- h. Native Americans Grave Repatriation Act - 25 U.S.C. Section 3001, et seq.
- i. Clean Air Act, P.L. 90-148, as amended.
- j. Coastal Zone Management Act, P.L. 93-205, as amended.
- k. Flood Disaster Protection Act of 1973 - Section 102(a) - 42 U.S.C. 4012a.<sup>1</sup>
- l. Title 49, U.S.C., Section 303, (formerly known as Section 4(f))
- m. Rehabilitation Act of 1973 - 29 U.S.C. 794.
- n. Title VI of the Civil Rights Act of 1964 (42 U.S.C. § 2000d et seq., 78 stat. 252) (prohibits discrimination on the basis of race, color, national origin);
- o. Americans with Disabilities Act of 1990, as amended, (42 U.S.C. § 12101 et seq.), prohibits discrimination on the basis of disability).
- p. Age Discrimination Act of 1975 - 42 U.S.C. 6101, et seq.
- q. American Indian Religious Freedom Act, P.L. 95-341, as amended.
- r. Architectural Barriers Act of 1968 -42 U.S.C. 4151, et seq.<sup>1</sup>
- s. Power plant and Industrial Fuel Use Act of 1978 - Section 403- 2 U.S.C. 8373.<sup>1</sup>
- t. Contract Work Hours and Safety Standards Act - 40 U.S.C. 327, et seq.<sup>1</sup>
- u. Copeland Anti-kickback Act - 18 U.S.C. 874.1
- v. National Environmental Policy Act of 1969 - 42 U.S.C. 4321, et seq.<sup>1</sup>
- w. Wild and Scenic Rivers Act, P.L. 90-542, as amended.
- x. Single Audit Act of 1984 - 31 U.S.C. 7501, et seq.<sup>2</sup>
- y. Drug-Free Workplace Act of 1988 - 41 U.S.C. 702 through 706.
- z. The Federal Funding Accountability and Transparency Act of 2006, as amended (Pub. L. 109-282, as amended by section 6202 of Pub. L. 110-252).

## EXECUTIVE ORDERS

---

- a. Executive Order 11246 - Equal Employment Opportunity<sup>1</sup>
- b. Executive Order 11990 - Protection of Wetlands
- c. Executive Order 11998 –Flood Plain Management
- d. Executive Order 12372 - Intergovernmental Review of Federal Programs
- e. Executive Order 12699 - Seismic Safety of Federal and Federally Assisted New Building Construction<sup>1</sup>
- f. Executive Order 12898 - Environmental Justice
- g. Executive Order 13788 - Buy American and Hire American
- h. Executive Order 13858 – Strengthening Buy-American Preferences for Infrastructure Projects

## FEDERAL REGULATIONS

---

- a. 2 CFR Part180 – OMB Guidelines to Agencies on Government-wide Debarment and Suspension (Non-procurement).
- b. 2 CFR Part 200, Uniform Administrative Requirements, Cost Principles, and Audit Requirements for Federal Awards. [OMB Circular A-87 Cost Principles Applicable to Grants and Contracts with State and Local Governments, and OMB Circular A-133 - Audits of States, Local Governments, and Non-Profit Organizations].<sup>4,5,6</sup>
- c. 2 CFR Part 1200 – Non-procurement Suspension and Debarment
- d. 14 CFR Part 13 - Investigative and Enforcement Procedures14 CFR Part 16 - Rules of Practice For Federally Assisted Airport Enforcement Proceedings.
- e. 14 CFR Part 150 - Airport noise compatibility planning.
- f. 28 CFR Part 35- Discrimination on the Basis of Disability in State and Local Government Services.
- g. 28 CFR § 50.3 - U.S. Department of Justice Guidelines for Enforcement of Title VI of the Civil Rights Act of 1964.
- h. 29 CFR Part 1 - Procedures for predetermination of wage rates.<sup>1</sup>
- i. 29 CFR Part 3 - Contractors and subcontractors on public building or public work financed in whole or part by loans or grants from the United States.<sup>1</sup>
- j. 29 CFR Part 5 - Labor standards provisions applicable to contracts covering federally financed and assisted construction (also labor standards provisions applicable to non-construction contracts subject to the Contract Work Hours and Safety Standards Act).<sup>1</sup>
- k. 41 CFR Part 60 - Office of Federal Contract Compliance Programs, Equal Employment Opportunity, Department of Labor (Federal and federally assisted contracting requirements).<sup>1</sup>
- l. 49 CFR Part 18 - Uniform administrative requirements for grants and cooperative agreements to state and local governments.<sup>3</sup>
- m. 49 CFR Part 20 - New restrictions on lobbying.



- n. 49 CFR Part 21 – Nondiscrimination in federally-assisted programs of the Department of Transportation - effectuation of Title VI of the Civil Rights Act of 1964.
- o. 49 CFR Part 23 - Participation by Disadvantage Business Enterprise in Airport Concessions.
- p. 49 CFR Part 24 – Uniform Relocation Assistance and Real Property Acquisition for Federal and Federally Assisted Programs.<sup>1,2</sup>
- q. 49 CFR Part 26 – Participation by Disadvantaged Business Enterprises in Department of Transportation Programs.
- r. 49 CFR Part 27 – Nondiscrimination on the Basis of Handicap in Programs and Activities Receiving or Benefiting from Federal Financial Assistance.<sup>1</sup>
- s. 49 CFR Part 28 –Enforcement of Nondiscrimination on the Basis of Handicap in Programs or Activities conducted by the Department of Transportation.
- t. 49 CFR Part 30 - Denial of public works contracts to suppliers of goods and services of countries that deny procurement market access to U.S. contractors.
- u. 49 CFR Part 32 –Government-wide Requirements for Drug-Free Workplace (Financial Assistance)
- v. 49 CFR Part 37 –Transportation Services for Individuals with Disabilities (ADA).
- w. 49 CFR Part 41 - Seismic safety of Federal and federally assisted or regulated new building construction.

---

#### **SPECIFIC ASSURANCES**

Specific assurances required to be included in grant agreements by any of the above laws, regulations or circulars are incorporated by reference in this grant agreement.

---

#### **FOOTNOTES TO ASSURANCE C.1.**

- <sup>1</sup> These laws do not apply to airport planning sponsors.
- <sup>2</sup> These laws do not apply to private sponsors.
- <sup>3</sup> 49 CFR Part 18 and 2 CFR Part 200 contain requirements for State and Local Governments receiving Federal assistance. Any requirement levied upon State and Local Governments by this regulation and circular shall also be applicable to private sponsors receiving Federal assistance under Title 49, United States Code.
- <sup>4</sup> On December 26, 2013 at 78 FR 78590, the Office of Management and Budget (OMB) issued the Uniform Administrative Requirements, Cost Principles, and Audit Requirements for Federal Awards in 2 CFR Part 200. 2 CFR Part 200 replaces and combines the former Uniform Administrative Requirements for Grants (OMB Circular A-102 and Circular A-110 or 2 CFR Part 215 or Circular) as well as the Cost Principles (Circulars A-21 or 2 CFR part 220; Circular A-87 or 2 CFR part 225; and A-122, 2 CFR part 230). Additionally it replaces Circular A-133 guidance on the Single Annual Audit. In accordance with 2 CFR section 200.110, the standards set forth in Part 200 which affect administration of Federal awards issued by Federal agencies become effective once implemented by Federal agencies or when any future amendment to this Part becomes final. Federal agencies, including the Department of Transportation, must implement the policies and procedures applicable to Federal awards by promulgating a regulation to be effective by December 26, 2014 unless different provisions are required by statute or approved by OMB.

- <sup>5</sup> Cost principles established in 2 CFR part 200 subpart E must be used as guidelines for determining the eligibility of specific types of expenses.
- <sup>6</sup> Audit requirements established in 2 CFR part 200 subpart F are the guidelines for audits.

**2. Responsibility and Authority of the Sponsor.**

a. Public Agency Sponsor:

It has legal authority to apply for this grant, and to finance and carry out the proposed project; that a resolution, motion or similar action has been duly adopted or passed as an official act of the applicant's governing body authorizing the filing of the application, including all understandings and assurances contained therein, and directing and authorizing the person identified as the official representative of the applicant to act in connection with the application and to provide such additional information as may be required.

b. Private Sponsor:

It has legal authority to apply for this grant and to finance and carry out the proposed project and comply with all terms, conditions, and assurances of this grant agreement. It shall designate an official representative and shall in writing direct and authorize that person to file this application, including all understandings and assurances contained therein; to act in connection with this application; and to provide such additional information as may be required.

**3. Sponsor Fund Availability.**

It has sufficient funds available for that portion of the project costs which are not to be paid by the United States. It has sufficient funds available to assure operation and maintenance of items funded under this grant agreement which it will own or control.

**4. Good Title.**

- a. It, a public agency or the Federal government, holds good title, satisfactory to the Secretary, to the landing area of the airport or site thereof, or will give assurance satisfactory to the Secretary that good title will be acquired.
- b. For noise compatibility program projects to be carried out on the property of the sponsor, it holds good title satisfactory to the Secretary to that portion of the property upon which Federal funds will be expended or will give assurance to the Secretary that good title will be obtained.

**5. Preserving Rights and Powers.**

- a. It will not take or permit any action which would operate to deprive it of any of the rights and powers necessary to perform any or all of the terms, conditions, and assurances in this grant agreement without the written approval of the Secretary, and will act promptly to acquire, extinguish or modify any outstanding rights or claims of right of others which would interfere with such performance by the sponsor. This shall be done in a manner acceptable to the Secretary.
- b. Subject to the FAA Act of 2018, Public Law 115-254, Section 163, it will not sell, lease, encumber, or otherwise transfer or dispose of any part of its title or other interests in the property shown on Exhibit A to this application or, for a noise compatibility program project, that portion of the property upon which Federal funds have been expended, for the duration of the terms, conditions, and assurances in this grant agreement without approval by the

Secretary. If the transferee is found by the Secretary to be eligible under Title 49, United States Code, to assume the obligations of this grant agreement and to have the power, authority, and financial resources to carry out all such obligations, the sponsor shall insert in the contract or document transferring or disposing of the sponsor's interest, and make binding upon the transferee all of the terms, conditions, and assurances contained in this grant agreement.

- c. For all noise compatibility program projects which are to be carried out by another unit of local government or are on property owned by a unit of local government other than the sponsor, it will enter into an agreement with that government. Except as otherwise specified by the Secretary, that agreement shall obligate that government to the same terms, conditions, and assurances that would be applicable to it if it applied directly to the FAA for a grant to undertake the noise compatibility program project. That agreement and changes thereto must be satisfactory to the Secretary. It will take steps to enforce this agreement against the local government if there is substantial non-compliance with the terms of the agreement.
- d. For noise compatibility program projects to be carried out on privately owned property, it will enter into an agreement with the owner of that property which includes provisions specified by the Secretary. It will take steps to enforce this agreement against the property owner whenever there is substantial non-compliance with the terms of the agreement.
- e. If the sponsor is a private sponsor, it will take steps satisfactory to the Secretary to ensure that the airport will continue to function as a public-use airport in accordance with these assurances for the duration of these assurances.
- f. If an arrangement is made for management and operation of the airport by any agency or person other than the sponsor or an employee of the sponsor, the sponsor will reserve sufficient rights and authority to insure that the airport will be operated and maintained in accordance Title 49, United States Code, the regulations and the terms, conditions and assurances in this grant agreement and shall insure that such arrangement also requires compliance therewith.
- g. Sponsors of commercial service airports will not permit or enter into any arrangement that results in permission for the owner or tenant of a property used as a residence, or zoned for residential use, to taxi an aircraft between that property and any location on airport. Sponsors of general aviation airports entering into any arrangement that results in permission for the owner of residential real property adjacent to or near the airport must comply with the requirements of Sec. 136 of Public Law 112-95 and the sponsor assurances.

**6. Consistency with Local Plans.**

The project is reasonably consistent with plans (existing at the time of submission of this application) of public agencies that are authorized by the State in which the project is located to plan for the development of the area surrounding the airport.

**7. Consideration of Local Interest.**

It has given fair consideration to the interest of communities in or near where the project may be located.

**8. Consultation with Users.**

In making a decision to undertake any airport development project under Title 49, United States Code, it has undertaken reasonable consultations with affected parties using the airport at which project is proposed.

**9. Public Hearings.**

In projects involving the location of an airport, an airport runway, or a major runway extension, it has afforded the opportunity for public hearings for the purpose of considering the economic, social, and environmental effects of the airport or runway location and its consistency with goals and objectives of such planning as has been carried out by the community and it shall, when requested by the Secretary, submit a copy of the transcript of such hearings to the Secretary. Further, for such projects, it has on its management board either voting representation from the communities where the project is located or has advised the communities that they have the right to petition the Secretary concerning a proposed project.

**10. Metropolitan Planning Organization.**

In projects involving the location of an airport, an airport runway, or a major runway extension at a medium or large hub airport, the sponsor has made available to and has provided upon request to the metropolitan planning organization in the area in which the airport is located, if any, a copy of the proposed amendment to the airport layout plan to depict the project and a copy of any airport master plan in which the project is described or depicted.

**11. Pavement Preventive Maintenance.**

With respect to a project approved after January 1, 1995, for the replacement or reconstruction of pavement at the airport, it assures or certifies that it has implemented an effective airport pavement maintenance-management program and it assures that it will use such program for the useful life of any pavement constructed, reconstructed or repaired with Federal financial assistance at the airport. It will provide such reports on pavement condition and pavement management programs as the Secretary determines may be useful.

**12. Terminal Development Prerequisites.**

For projects which include terminal development at a public use airport, as defined in Title 49, it has, on the date of submittal of the project grant application, all the safety equipment required for certification of such airport under section 44706 of Title 49, United States Code, and all the security equipment required by rule or regulation, and has provided for access to the passenger enplaning and deplaning area of such airport to passengers enplaning and deplaning from aircraft other than air carrier aircraft.

**13. Accounting System, Audit, and Record Keeping Requirements.**

- a. It shall keep all project accounts and records which fully disclose the amount and disposition by the recipient of the proceeds of this grant, the total cost of the project in connection with which this grant is given or used, and the amount or nature of that portion of the cost of the project supplied by other sources, and such other financial records pertinent to the project. The accounts and records shall be kept in accordance with an accounting system that will facilitate an effective audit in accordance with the Single Audit Act of 1984.
- b. It shall make available to the Secretary and the Comptroller General of the United States, or any of their duly authorized representatives, for the purpose of audit and examination, any books, documents, papers, and records of the recipient that are pertinent to this grant. The Secretary may require that an appropriate audit be conducted by a recipient. In any case in which an independent audit is made of the accounts of a sponsor relating to the disposition of the proceeds of a grant or relating to the project in connection with which this grant was given or used, it shall file a certified copy of such audit with the Comptroller General of the United States not later than six (6) months following the close of the fiscal year for which the audit was made.

**14. Minimum Wage Rates.**

It shall include, in all contracts in excess of \$2,000 for work on any projects funded under this grant agreement which involve labor, provisions establishing minimum rates of wages, to be predetermined by the Secretary of Labor, in accordance with the Davis-Bacon Act, as amended (40 U.S.C. 276a-276a-5), which contractors shall pay to skilled and unskilled labor, and such minimum rates shall be stated in the invitation for bids and shall be included in proposals or bids for the work.

**15. Veteran's Preference.**

It shall include in all contracts for work on any project funded under this grant agreement which involve labor, such provisions as are necessary to insure that, in the employment of labor (except in executive, administrative, and supervisory positions), preference shall be given to Vietnam era veterans, Persian Gulf veterans, Afghanistan-Iraq war veterans, disabled veterans, and small business concerns owned and controlled by disabled veterans as defined in Section 47112 of Title 49, United States Code. However, this preference shall apply only where the individuals are available and qualified to perform the work to which the employment relates.

**16. Conformity to Plans and Specifications.**

It will execute the project subject to plans, specifications, and schedules approved by the Secretary. Such plans, specifications, and schedules shall be submitted to the Secretary prior to commencement of site preparation, construction, or other performance under this grant agreement, and, upon approval of the Secretary, shall be incorporated into this grant agreement. Any modification to the approved plans, specifications, and schedules shall also be subject to approval of the Secretary, and incorporated into this grant agreement.

**17. Construction Inspection and Approval.**

It will provide and maintain competent technical supervision at the construction site throughout the project to assure that the work conforms to the plans, specifications, and schedules approved by the Secretary for the project. It shall subject the construction work on any project contained in an approved project application to inspection and approval by the Secretary and such work shall be in accordance with regulations and procedures prescribed by the Secretary. Such regulations and procedures shall require such cost and progress reporting by the sponsor or sponsors of such project as the Secretary shall deem necessary.

**18. Planning Projects.**

In carrying out planning projects:

- a. It will execute the project in accordance with the approved program narrative contained in the project application or with the modifications similarly approved.
- b. It will furnish the Secretary with such periodic reports as required pertaining to the planning project and planning work activities.
- c. It will include in all published material prepared in connection with the planning project a notice that the material was prepared under a grant provided by the United States.
- d. It will make such material available for examination by the public, and agrees that no material prepared with funds under this project shall be subject to copyright in the United States or any other country.
- e. It will give the Secretary unrestricted authority to publish, disclose, distribute, and otherwise use any of the material prepared in connection with this grant.

- f. It will grant the Secretary the right to disapprove the sponsor's employment of specific consultants and their subcontractors to do all or any part of this project as well as the right to disapprove the proposed scope and cost of professional services.
- g. It will grant the Secretary the right to disapprove the use of the sponsor's employees to do all or any part of the project.
- h. It understands and agrees that the Secretary's approval of this project grant or the Secretary's approval of any planning material developed as part of this grant does not constitute or imply any assurance or commitment on the part of the Secretary to approve any pending or future application for a Federal airport grant.

**19. Operation and Maintenance.**

- a. The airport and all facilities which are necessary to serve the aeronautical users of the airport, other than facilities owned or controlled by the United States, shall be operated at all times in a safe and serviceable condition and in accordance with the minimum standards as may be required or prescribed by applicable Federal, state and local agencies for maintenance and operation. It will not cause or permit any activity or action thereon which would interfere with its use for airport purposes. It will suitably operate and maintain the airport and all facilities thereon or connected therewith, with due regard to climatic and flood conditions. Any proposal to temporarily close the airport for non-aeronautical purposes must first be approved by the Secretary. In furtherance of this assurance, the sponsor will have in effect arrangements for-
  - 1) Operating the airport's aeronautical facilities whenever required;
  - 2) Promptly marking and lighting hazards resulting from airport conditions, including temporary conditions; and
  - 3) Promptly notifying airmen of any condition affecting aeronautical use of the airport. Nothing contained herein shall be construed to require that the airport be operated for aeronautical use during temporary periods when snow, flood or other climatic conditions interfere with such operation and maintenance. Further, nothing herein shall be construed as requiring the maintenance, repair, restoration, or replacement of any structure or facility which is substantially damaged or destroyed due to an act of God or other condition or circumstance beyond the control of the sponsor.
- b. It will suitably operate and maintain noise compatibility program items that it owns or controls upon which Federal funds have been expended.

**20. Hazard Removal and Mitigation.**

It will take appropriate action to assure that such terminal airspace as is required to protect instrument and visual operations to the airport (including established minimum flight altitudes) will be adequately cleared and protected by removing, lowering, relocating, marking, or lighting or otherwise mitigating existing airport hazards and by preventing the establishment or creation of future airport hazards.

**21. Compatible Land Use.**

It will take appropriate action, to the extent reasonable, including the adoption of zoning laws, to restrict the use of land adjacent to or in the immediate vicinity of the airport to activities and purposes compatible with normal airport operations, including landing and takeoff of aircraft. In addition, if the project is for noise compatibility program implementation, it will not cause or permit any change in land use, within its jurisdiction, that will reduce its compatibility, with

respect to the airport, of the noise compatibility program measures upon which Federal funds have been expended.

## 22. Economic Nondiscrimination.

- a. It will make the airport available as an airport for public use on reasonable terms and without unjust discrimination to all types, kinds and classes of aeronautical activities, including commercial aeronautical activities offering services to the public at the airport.
- b. In any agreement, contract, lease, or other arrangement under which a right or privilege at the airport is granted to any person, firm, or corporation to conduct or to engage in any aeronautical activity for furnishing services to the public at the airport, the sponsor will insert and enforce provisions requiring the contractor to-
  - 1) furnish said services on a reasonable, and not unjustly discriminatory, basis to all users thereof, and
  - 2) charge reasonable, and not unjustly discriminatory, prices for each unit or service, provided that the contractor may be allowed to make reasonable and nondiscriminatory discounts, rebates, or other similar types of price reductions to volume purchasers.
- c. Each fixed-based operator at the airport shall be subject to the same rates, fees, rentals, and other charges as are uniformly applicable to all other fixed-based operators making the same or similar uses of such airport and utilizing the same or similar facilities.
- d. Each air carrier using such airport shall have the right to service itself or to use any fixed-based operator that is authorized or permitted by the airport to serve any air carrier at such airport.
- e. Each air carrier using such airport (whether as a tenant, non-tenant, or subtenant of another air carrier tenant) shall be subject to such nondiscriminatory and substantially comparable rules, regulations, conditions, rates, fees, rentals, and other charges with respect to facilities directly and substantially related to providing air transportation as are applicable to all such air carriers which make similar use of such airport and utilize similar facilities, subject to reasonable classifications such as tenants or non-tenants and signatory carriers and non-signatory carriers. Classification or status as tenant or signatory shall not be unreasonably withheld by any airport provided an air carrier assumes obligations substantially similar to those already imposed on air carriers in such classification or status.
- f. It will not exercise or grant any right or privilege which operates to prevent any person, firm, or corporation operating aircraft on the airport from performing any services on its own aircraft with its own employees [including, but not limited to maintenance, repair, and fueling] that it may choose to perform.
- g. In the event the sponsor itself exercises any of the rights and privileges referred to in this assurance, the services involved will be provided on the same conditions as would apply to the furnishing of such services by commercial aeronautical service providers authorized by the sponsor under these provisions.
- h. The sponsor may establish such reasonable, and not unjustly discriminatory, conditions to be met by all users of the airport as may be necessary for the safe and efficient operation of the airport.

- i. The sponsor may prohibit or limit any given type, kind or class of aeronautical use of the airport if such action is necessary for the safe operation of the airport or necessary to serve the civil aviation needs of the public.

**23. Exclusive Rights.**

It will permit no exclusive right for the use of the airport by any person providing, or intending to provide, aeronautical services to the public. For purposes of this paragraph, the providing of the services at an airport by a single fixed-based operator shall not be construed as an exclusive right if both of the following apply:

- a. It would be unreasonably costly, burdensome, or impractical for more than one fixed-based operator to provide such services, and
- b. If allowing more than one fixed-based operator to provide such services would require the reduction of space leased pursuant to an existing agreement between such single fixed-based operator and such airport. It further agrees that it will not, either directly or indirectly, grant or permit any person, firm, or corporation, the exclusive right at the airport to conduct any aeronautical activities, including, but not limited to charter flights, pilot training, aircraft rental and sightseeing, aerial photography, crop dusting, aerial advertising and surveying, air carrier operations, aircraft sales and services, sale of aviation petroleum products whether or not conducted in conjunction with other aeronautical activity, repair and maintenance of aircraft, sale of aircraft parts, and any other activities which because of their direct relationship to the operation of aircraft can be regarded as an aeronautical activity, and that it will terminate any exclusive right to conduct an aeronautical activity now existing at such an airport before the grant of any assistance under Title 49, United States Code.

**24. Fee and Rental Structure.**

It will maintain a fee and rental structure for the facilities and services at the airport which will make the airport as self-sustaining as possible under the circumstances existing at the particular airport, taking into account such factors as the volume of traffic and economy of collection. No part of the Federal share of an airport development, airport planning or noise compatibility project for which a grant is made under Title 49, United States Code, the Airport and Airway Improvement Act of 1982, the Federal Airport Act or the Airport and Airway Development Act of 1970 shall be included in the rate basis in establishing fees, rates, and charges for users of that airport.

**25. Airport Revenues.**

- a. All revenues generated by the airport and any local taxes on aviation fuel established after December 30, 1987, will be expended by it for the capital or operating costs of the airport; the local airport system; or other local facilities which are owned or operated by the owner or operator of the airport and which are directly and substantially related to the actual air transportation of passengers or property; or for noise mitigation purposes on or off the airport. The following exceptions apply to this paragraph:
  - 1) If covenants or assurances in debt obligations issued before September 3, 1982, by the owner or operator of the airport, or provisions enacted before September 3, 1982, in governing statutes controlling the owner or operator's financing, provide for the use of the revenues from any of the airport owner or operator's facilities, including the airport, to support not only the airport but also the airport owner or operator's general debt obligations or other facilities, then this limitation on the use of all revenues generated



by the airport (and, in the case of a public airport, local taxes on aviation fuel) shall not apply.

- 2) If the Secretary approves the sale of a privately owned airport to a public sponsor and provides funding for any portion of the public sponsor's acquisition of land, this limitation on the use of all revenues generated by the sale shall not apply to certain proceeds from the sale. This is conditioned on repayment to the Secretary by the private owner of an amount equal to the remaining unamortized portion (amortized over a 20-year period) of any airport improvement grant made to the private owner for any purpose other than land acquisition on or after October 1, 1996, plus an amount equal to the federal share of the current fair market value of any land acquired with an airport improvement grant made to that airport on or after October 1, 1996.
- 3) Certain revenue derived from or generated by mineral extraction, production, lease, or other means at a general aviation airport (as defined at Section 47102 of title 49 United States Code), if the FAA determines the airport sponsor meets the requirements set forth in Sec. 813 of Public Law 112-95.
  - b. As part of the annual audit required under the Single Audit Act of 1984, the sponsor will direct that the audit will review, and the resulting audit report will provide an opinion concerning, the use of airport revenue and taxes in paragraph (a), and indicating whether funds paid or transferred to the owner or operator are paid or transferred in a manner consistent with Title 49, United States Code and any other applicable provision of law, including any regulation promulgated by the Secretary or Administrator.
  - c. Any civil penalties or other sanctions will be imposed for violation of this assurance in accordance with the provisions of Section 47107 of Title 49, United States Code.

## 26. Reports and Inspections.

It will:

- a. submit to the Secretary such annual or special financial and operations reports as the Secretary may reasonably request and make such reports available to the public; make available to the public at reasonable times and places a report of the airport budget in a format prescribed by the Secretary;
- b. for airport development projects, make the airport and all airport records and documents affecting the airport, including deeds, leases, operation and use agreements, regulations and other instruments, available for inspection by any duly authorized agent of the Secretary upon reasonable request;
- c. for noise compatibility program projects, make records and documents relating to the project and continued compliance with the terms, conditions, and assurances of this grant agreement including deeds, leases, agreements, regulations, and other instruments, available for inspection by any duly authorized agent of the Secretary upon reasonable request; and
- d. in a format and time prescribed by the Secretary, provide to the Secretary and make available to the public following each of its fiscal years, an annual report listing in detail:
  - 1) all amounts paid by the airport to any other unit of government and the purposes for which each such payment was made; and
  - 2) all services and property provided by the airport to other units of government and the amount of compensation received for provision of each such service and property.

**27. Use by Government Aircraft.**

It will make available all of the facilities of the airport developed with Federal financial assistance and all those usable for landing and takeoff of aircraft to the United States for use by Government aircraft in common with other aircraft at all times without charge, except, if the use by Government aircraft is substantial, charge may be made for a reasonable share, proportional to such use, for the cost of operating and maintaining the facilities used. Unless otherwise determined by the Secretary, or otherwise agreed to by the sponsor and the using agency, substantial use of an airport by Government aircraft will be considered to exist when operations of such aircraft are in excess of those which, in the opinion of the Secretary, would unduly interfere with use of the landing areas by other authorized aircraft, or during any calendar month that –

- a. Five (5) or more Government aircraft are regularly based at the airport or on land adjacent thereto; or
- b. The total number of movements (counting each landing as a movement) of Government aircraft is 300 or more, or the gross accumulative weight of Government aircraft using the airport (the total movement of Government aircraft multiplied by gross weights of such aircraft) is in excess of five million pounds.

**28. Land for Federal Facilities.**

It will furnish without cost to the Federal Government for use in connection with any air traffic control or air navigation activities, or weather-reporting and communication activities related to air traffic control, any areas of land or water, or estate therein, or rights in buildings of the sponsor as the Secretary considers necessary or desirable for construction, operation, and maintenance at Federal expense of space or facilities for such purposes. Such areas or any portion thereof will be made available as provided herein within four months after receipt of a written request from the Secretary.

**29. Airport Layout Plan.**

- a. Subject to the FAA Reauthorization Act of 2018, Public Law 115-254, Section 163, it will keep up to date at all times an airport layout plan of the airport showing:
  - 1) boundaries of the airport and all proposed additions thereto, together with the boundaries of all offsite areas owned or controlled by the sponsor for airport purposes and proposed additions thereto;
  - 2) the location and nature of all existing and proposed airport facilities and structures (such as runways, taxiways, aprons, terminal buildings, hangars and roads), including all proposed extensions and reductions of existing airport facilities;
  - 3) the location of all existing and proposed non-aviation areas and of all existing improvements thereon; and
  - 4) all proposed and existing access points used to taxi aircraft across the airport's property boundary. Such airport layout plans and each amendment, revision, or modification thereof, shall be subject to the approval of the Secretary which approval shall be evidenced by the signature of a duly authorized representative of the Secretary on the face of the airport layout plan. The sponsor will not make or permit any changes or alterations in the airport or any of its facilities which are not in conformity

with the airport layout plan as approved by the Secretary and which might, in the opinion of the Secretary, adversely affect the safety, utility or efficiency of the airport.

- b. Subject to the FAA Reauthorization Act of 2018, Public Law 115-254, Section 163, if a change or alteration in the airport or the facilities is made which the Secretary determines adversely affects the safety, utility, or efficiency of any federally owned, leased, or funded property on or off the airport and which is not in conformity with the airport layout plan as approved by the Secretary, the owner or operator will, if requested, by the Secretary (1) eliminate such adverse effect in a manner approved by the Secretary; or (2) bear all costs of relocating such property (or replacement thereof) to a site acceptable to the Secretary and all costs of restoring such property (or replacement thereof) to the level of safety, utility, efficiency, and cost of operation existing before the unapproved change in the airport or its facilities except in the case of a relocation or replacement of an existing airport facility due to a change in the Secretary's design standards beyond the control of the airport sponsor.

### 30. **Civil Rights.**

It will promptly take any measures necessary to ensure that no person in the United States shall, on the grounds of race, creed, color, national origin, sex, age, or disability be excluded from participation in, be denied the benefits of, or be otherwise subjected to discrimination in any activity conducted with, or benefiting from, funds received from this grant.

- a. Using the definitions of activity, facility and program as found and defined in §§ 21.23 (b) and 21.23 (e) of 49 CFR § 21, the sponsor will facilitate all programs, operate all facilities, or conduct all programs in compliance with all non-discrimination requirements imposed by, or pursuant to these assurances.
- b. **Applicability**
- 1) **Programs and Activities.** If the sponsor has received a grant (or other federal assistance) for any of the sponsor's program or activities, these requirements extend to all of the sponsor's programs and activities.
  - 2) **Facilities.** Where it receives a grant or other federal financial assistance to construct, expand, renovate, remodel, alter or acquire a facility, or part of a facility, the assurance extends to the entire facility and facilities operated in connection therewith.
  - 3) **Real Property.** Where the sponsor receives a grant or other Federal financial assistance in the form of, or for the acquisition of real property or an interest in real property, the assurance will extend to rights to space on, over, or under such property.

c. **Duration.**

The sponsor agrees that it is obligated to this assurance for the period during which Federal financial assistance is extended to the program, except where the Federal financial assistance is to provide, or is in the form of, personal property, or real property, or interest therein, or structures or improvements thereon, in which case the assurance obligates the sponsor, or any transferee for the longer of the following periods:

- 1) So long as the airport is used as an airport, or for another purpose involving the provision of similar services or benefits; or
- 2) So long as the sponsor retains ownership or possession of the property.

- d. Required Solicitation Language. It will include the following notification in all solicitations for bids, Requests For Proposals for work, or material under this grant agreement and in all proposals for agreements, including airport concessions, regardless of funding source:

“The **(Name of Sponsor)**, in accordance with the provisions of Title VI of the Civil Rights Act of 1964 (78 Stat. 252, 42 U.S.C. §§ 2000d to 2000d-4) and the Regulations, hereby notifies all bidders that it will affirmatively ensure that any contract entered into pursuant to this advertisement, disadvantaged business enterprises and airport concession disadvantaged business enterprises will be afforded full and fair opportunity to submit bids in response to this invitation and will not be discriminated against on the grounds of race, color, or national origin in consideration for an award.”

- e. Required Contract Provisions.

- 1) It will insert the non-discrimination contract clauses requiring compliance with the acts and regulations relative to non-discrimination in Federally-assisted programs of the DOT, and incorporating the acts and regulations into the contracts by reference in every contract or agreement subject to the non-discrimination in Federally-assisted programs of the DOT acts and regulations.
- 2) It will include a list of the pertinent non-discrimination authorities in every contract that is subject to the non-discrimination acts and regulations.
- 3) It will insert non-discrimination contract clauses as a covenant running with the land, in any deed from the United States effecting or recording a transfer of real property, structures, use, or improvements thereon or interest therein to a sponsor.
- 4) It will insert non-discrimination contract clauses prohibiting discrimination on the basis of race, color, national origin, creed, sex, age, or handicap as a covenant running with the land, in any future deeds, leases, license, permits, or similar instruments entered into by the sponsor with other parties:
  - a. For the subsequent transfer of real property acquired or improved under the applicable activity, project, or program; and
  - b. For the construction or use of, or access to, space on, over, or under real property acquired or improved under the applicable activity, project, or program.
- f. It will provide for such methods of administration for the program as are found by the Secretary to give reasonable guarantee that it, other recipients, sub-recipients, sub-grantees, contractors, subcontractors, consultants, transferees, successors in interest, and other participants of Federal financial assistance under such program will comply with all requirements imposed or pursuant to the acts, the regulations, and this assurance.
- g. It agrees that the United States has a right to seek judicial enforcement with regard to any matter arising under the acts, the regulations, and this assurance.

**31. Disposal of Land.**

- a. For land purchased under a grant for airport noise compatibility purposes, including land serving as a noise buffer, it will dispose of the land, when the land is no longer needed for such purposes, at fair market value, at the earliest practicable time. That portion of the proceeds of such disposition which is proportionate to the United States' share of acquisition of such land will be, at the discretion of the Secretary, (1) reinvested in another project at the airport, or (2) transferred to another eligible airport as prescribed by the Secretary. The Secretary shall give preference to the following, in descending order, (1)

reinvestment in an approved noise compatibility project, (2) reinvestment in an approved project that is eligible for grant funding under Section 47117(e) of title 49 United States Code, (3) reinvestment in an approved airport development project that is eligible for grant funding under Sections 47114, 47115, or 47117 of title 49 United States Code, (4) transferred to an eligible sponsor of another public airport to be reinvested in an approved noise compatibility project at that airport, and (5) paid to the Secretary for deposit in the Airport and Airway Trust Fund. If land acquired under a grant for noise compatibility purposes is leased at fair market value and consistent with noise buffering purposes, the lease will not be considered a disposal of the land. Revenues derived from such a lease may be used for an approved airport development project that would otherwise be eligible for grant funding or any permitted use of airport revenue.

- b. For land purchased under a grant for airport development purposes (other than noise compatibility), it will, when the land is no longer needed for airport purposes, dispose of such land at fair market value or make available to the Secretary an amount equal to the United States' proportionate share of the fair market value of the land. That portion of the proceeds of such disposition which is proportionate to the United States' share of the cost of acquisition of such land will, (1) upon application to the Secretary, be reinvested or transferred to another eligible airport as prescribed by the Secretary. The Secretary shall give preference to the following, in descending order: (1) reinvestment in an approved noise compatibility project, (2) reinvestment in an approved project that is eligible for grant funding under Section 47117(e) of title 49 United States Code, (3) reinvestment in an approved airport development project that is eligible for grant funding under Sections 47114, 47115, or 47117 of title 49 United States Code, (4) transferred to an eligible sponsor of another public airport to be reinvested in an approved noise compatibility project at that airport, and (5) paid to the Secretary for deposit in the Airport and Airway Trust Fund.
- c. Land shall be considered to be needed for airport purposes under this assurance if (1) it may be needed for aeronautical purposes (including runway protection zones) or serve as noise buffer land, and (2) the revenue from interim uses of such land contributes to the financial self-sufficiency of the airport. Further, land purchased with a grant received by an airport operator or owner before December 31, 1987, will be considered to be needed for airport purposes if the Secretary or Federal agency making such grant before December 31, 1987, was notified by the operator or owner of the uses of such land, did not object to such use, and the land continues to be used for that purpose, such use having commenced no later than December 15, 1989.
- d. Disposition of such land under (a) (b) or (c) will be subject to the retention or reservation of any interest or right therein necessary to ensure that such land will only be used for purposes which are compatible with noise levels associated with operation of the airport.

### **32. Engineering and Design Services.**

Engineering and Design Services. If any phase of such project has received Federal funds under Chapter 471 subchapter 1 of Title 49 U.S.C., it will award each contract, or sub-contract for program management, construction management, planning studies, feasibility studies, architectural services, preliminary engineering, design, engineering, surveying, mapping or related services in the same manner as a contract for architectural and engineering services is negotiated under Chapter 11 of Title 40 U. S. C., or an equivalent qualifications-based requirement prescribed for or by the sponsor of the airport.

**33. Foreign Market Restrictions.**

It will not allow funds provided under this grant to be used to fund any project which uses any product or service of a foreign country during the period in which such foreign country is listed by the United States Trade Representative as denying fair and equitable market opportunities for products and suppliers of the United States in procurement and construction.

**34. Policies, Standards, and Specifications.**

It will carry out the project in accordance with policies, standards, and specifications approved by the Secretary including, but not limited to, the advisory circulars listed in the Current FAA Advisory Circulars for AIP projects, dated \_\_\_\_\_, and included in this grant, and in accordance with applicable state policies, standards, and specifications approved by the Secretary.

**35. Relocation and Real Property Acquisition.**

- a. It will be guided in acquiring real property, to the greatest extent practicable under State law, by the land acquisition policies in Subpart B of 49 CFR Part 24 and will pay or reimburse property owners for necessary expenses as specified in Subpart B.
- b. It will provide a relocation assistance program offering the services described in Subpart C and fair and reasonable relocation payments and assistance to displaced persons as required in Subpart D and E of 49 CFR Part 24.
- c. It will make available within a reasonable period of time prior to displacement, comparable replacement dwellings to displaced persons in accordance with Subpart E of 49 CFR Part 24.

**36. Access By Intercity Buses.**

The airport owner or operator will permit, to the maximum extent practicable, intercity buses or other modes of transportation to have access to the airport; however, it has no obligation to fund special facilities for intercity buses or for other modes of transportation.

**37. Disadvantaged Business Enterprises.**

The sponsor shall not discriminate on the basis of race, color, national origin or sex in the award and performance of any DOT-assisted contract covered by 49 CFR Part 26, or in the award and performance of any concession activity contract covered by 49 CFR Part 23. In addition, the sponsor shall not discriminate on the basis of race, color, national origin or sex in the administration of its Disadvantaged Business Enterprise (DBE) and Airport Concessions Disadvantaged Business Enterprise (ACDBE) programs or the requirements of 49 CFR Parts 23 and 26. The sponsor shall take all necessary and reasonable steps under 49 CFR Parts 23 and 26 to ensure nondiscrimination in the award and administration of DOT-assisted contracts, and/or concession contracts. The sponsor's DBE and ACDBE programs, as required by 49 CFR Parts 26 and 23, and as approved by DOT, are incorporated by reference in this agreement. Implementation of these programs is a legal obligation and failure to carry out its terms shall be treated as a violation of this agreement. Upon notification to the sponsor of its failure to carry out its approved program, the Department may impose sanctions as provided for under Parts 26 and 23 and may, in appropriate cases, refer the matter for enforcement under 18 U.S.C. 1001 and/or the Program Fraud Civil Remedies Act of 1936 (31 U.S.C. 3801).

**38. Hangar Construction.**

If the airport owner or operator and a person who owns an aircraft agree that a hangar is to be constructed at the airport for the aircraft at the aircraft owner's expense, the airport owner or

operator will grant to the aircraft owner for the hangar a long term lease that is subject to such terms and conditions on the hangar as the airport owner or operator may impose.

**39. Competitive Access.**

- a. If the airport owner or operator of a medium or large hub airport (as defined in section 47102 of title 49, U.S.C.) has been unable to accommodate one or more requests by an air carrier for access to gates or other facilities at that airport in order to allow the air carrier to provide service to the airport or to expand service at the airport, the airport owner or operator shall transmit a report to the Secretary that-
  - 1) Describes the requests;
  - 2) Provides an explanation as to why the requests could not be accommodated; and
  - 3) Provides a time frame within which, if any, the airport will be able to accommodate the requests.
- b. Such report shall be due on either February 1 or August 1 of each year if the airport has been unable to accommodate the request(s) in the six month period prior to the applicable due date.

**EXHIBIT N**



## **I. PROVISIONS APPLICABLE TO ALL LEASES**

### **A. ACCESS TO RECORDS AND REPORTS**

The contractor (Airline) must maintain an acceptable cost accounting system. The contractor agrees to provide the sponsor (City), the Federal Aviation Administration, and the Comptroller General of the United States or any of their duly authorized representatives' access to any books, documents, papers, and records of the contractor which are directly pertinent to the specific contract for the purpose of making audit, examination, excerpts and transcriptions. The contractor agrees to maintain all books, records and reports required under this contract for a period of not less than three years after final payment is made and all pending matters are closed.

### **B. BUY AMERICAN CERTIFICATION**

The contractor agrees to comply with 49 USC § 50101, which provides that Federal funds may not be obligated unless all steel and manufactured goods used in AIP-funded projects are produced in the United States, unless the FAA has issued a waiver for the product; the product is listed as an Excepted Article, Material Or Supply in Federal Acquisition Regulation subpart 25.108; or is included in the FAA Nationwide Buy American Waivers Issued list.

A bidder or offeror must submit the appropriate Buy America Certification (below) with all bids or offers on Airport Improvement Program ("AIP")-funded projects. Bids or offers that are not accompanied by a completed Buy America certification must be rejected as nonresponsive.

#### **Type of Certification is based on Type of Project:**

There are two types of Buy American certifications.

- For projects for a facility, the Certificate of Compliance Based on Total Facility (Terminal or Building Project) must be submitted.
- For all other projects, the Certificate of Compliance Based on Equipment and Materials Used on the Project (Non-building construction projects such as runway or roadway construction; or equipment acquisition projects) must be submitted.

See Attachments A and B: Buy American Certifications

### **C. GENERAL CIVIL RIGHTS PROVISIONS**

The contractor agrees that it will comply with pertinent statutes, Executive Orders and such rules as are promulgated to ensure that no person shall, on the grounds of race, creed, color, national origin, sex, age, or handicap be excluded from participating in any activity conducted with or benefiting from Federal assistance.

This provision binds the contractor from the bid solicitation period through the completion of the contract. This provision is in addition to that required of Title VI of the Civil Rights Act of 1964.

### **D. CIVIL RIGHTS ACT OF 1964, TITLE VI**

During the performance of this contract, the contractor, for itself, its assignees, and successors in interest (hereinafter referred to as the “contractor”) agrees as follows:

- 1. Compliance with Regulations:** The contractor (hereinafter includes consultants) will comply with the Title VI List of Pertinent Nondiscrimination Acts And Authorities, as they may be amended from time to time, which are herein incorporated by reference and made a part of this contract.
- 2. Non-discrimination:** The contractor, with regard to the work performed by it during the contract, will not discriminate on the grounds of race, color, or national origin in the selection and retention of subcontractors, including procurements of materials and leases of equipment. The contractor will not participate directly or indirectly in the discrimination prohibited by the Nondiscrimination Acts and Authorities, including employment practices when the contract covers any activity, project, or program set forth in Appendix B of 49 CFR part 21.
- 3. Solicitations for Subcontracts, Including Procurements of Materials and Equipment:** In all solicitations, either by competitive bidding, or negotiation made by the contractor for work to be performed under a subcontract, including procurements of materials, or leases of equipment, each potential subcontractor or supplier will be notified by the contractor of the contractor’s obligations under this contract and the Nondiscrimination Acts And Authorities on the grounds of race, color, or national origin.
- 4. Information and Reports:** The contractor will provide all information and reports required by the Acts, the Regulations, and directives issued pursuant thereto and will permit access to its books, records, accounts, other sources of information, and its facilities as may be determined by the sponsor or the Federal Aviation Administration to be pertinent to ascertain compliance with such Nondiscrimination Acts And Authorities and instructions. Where any information required of a contractor is in the exclusive possession of another who fails or refuses to furnish the information, the contractor will so certify to the sponsor or the Federal Aviation Administration, as appropriate, and will set forth what efforts it has made to obtain the information.
- 5. Sanctions for Noncompliance:** In the event of a contractor’s noncompliance with the Non-discrimination provisions of this contract, the sponsor will impose such contract sanctions as it or the Federal Aviation Administration may determine to be appropriate, including, but not limited to:
  - a. Withholding payments to the contractor under the contract until the contractor complies; and/or

b. Cancelling, terminating, or suspending a contract, in whole or in part.

**6. Incorporation of Provisions:** The contractor will include the provisions of paragraphs one through six in every subcontract, including procurements of materials and leases of equipment, unless exempt by the Acts, the Regulations and directives issued pursuant thereto. The contractor will take action with respect to any subcontract or procurement as the sponsor or the Federal Aviation Administration may direct as a means of enforcing such provisions including sanctions for noncompliance. Provided, that if the contractor becomes involved in, or is threatened with litigation by a subcontractor, or supplier because of such direction, the contractor may request the sponsor to enter into any litigation to protect the interests of the sponsor. In addition, the contractor may request the United States to enter into the litigation to protect the interests of the United States.

**7. Use or Access to Real Property Acquired Under the Activity, Facility or Program:**

- A. The contractor for himself/herself, his/her heirs, personal representatives, successors in interest, and assigns, as a part of the consideration hereof, does hereby covenant and agree (in the case of deeds and leases add, "as a covenant running with the land") that (1) no person on the ground of race, color, or national origin, will be excluded from participation in, denied the benefits of, or be otherwise subjected to discrimination in the use of said facilities, (2) that in the construction of any improvements on, over, or under such land, and the furnishing of services thereon, no person on the ground of race, color, or national origin, will be excluded from participation in, denied the benefits of, or otherwise be subjected to discrimination, (3) that the (grantee, licensee, lessee, permittee, etc.) will use the premises in compliance with all other requirements imposed by or pursuant to the List of discrimination Acts And Authorities.
- B. With respect to leases and permits, in the event of breach of any of the above nondiscrimination covenants, City will have the right to terminate the lease or permit and to enter or re-enter and repossess said land and the facilities thereon, and hold the same as if said lease or permit had never been made or issued.

## 8. Title VI List of Pertinent Nondiscrimination Acts and Authorities

During the performance of this contract, the contractor, for itself, its assignees, and successors in interest (hereinafter referred to as the “contractor”) agrees to comply with the following non-discrimination statutes and authorities; where applicable to Southwest Airlines, including but not limited to:

- a. Title VI of the Civil Rights Act of 1964 (42 U.S.C. § 2000d *et seq.*, 78 stat. 252), (prohibits discrimination on the basis of race, color, national origin);
- b. 49 CFR part 21 (Non-discrimination In Federally-Assisted Programs of The Department of Transportation—Effectuation of Title VI of The Civil Rights Act of 1964);
- c. The Uniform Relocation Assistance and Real Property Acquisition Policies Act of 1970, (42 U.S.C. § 4601), (prohibits unfair treatment of persons displaced or whose property has been acquired because of Federal or Federal-aid programs and projects);
- d. Section 504 of the Rehabilitation Act of 1973, (29 U.S.C. § 794 *et seq.*), as amended, (prohibits discrimination on the basis of disability); and 49 CFR part 27;
- e. The Age Discrimination Act of 1975, as amended, (42 U.S.C. § 6101 *et seq.*), (prohibits discrimination on the basis of age);
- f. Airport and Airway Improvement Act of 1982, (49 USC § 471, Section 47123), as amended, (prohibits discrimination based on race, creed, color, national origin, or sex);
- g. The Civil Rights Restoration Act of 1987, (PL 100-209), (Broadened the scope, coverage and applicability of Title VI of the Civil Rights Act of 1964, The Age Discrimination Act of 1975 and Section 504 of the Rehabilitation Act of 1973, by expanding the definition of the terms “programs or activities” to include all of the programs or activities of the Federal-aid recipients, sub-recipients and contractors, whether such programs or activities are Federally funded or not);
- h. Titles II and III of the Americans with Disabilities Act of 1990, which prohibit discrimination on the basis of disability in the operation of public entities, public and private transportation systems, places of public accommodation, and certain testing entities (42 U.S.C. §§ 12131 – 12189) as implemented by Department of Transportation regulations at 49 CFR parts 37 and 38;
- i. The Federal Aviation Administration’s Non-discrimination statute (49 U.S.C. § 47123) (prohibits discrimination on the basis of race, color, national origin, and sex);
- j. Executive Order 12898, Federal Actions to Address Environmental Justice in Minority Populations and Low-Income Populations, which ensures non-

discrimination against minority populations by discouraging programs, policies, and activities with disproportionately high and adverse human health or environmental effects on minority and low-income populations;

- k. Executive Order 13166, Improving Access to Services for Persons with Limited English Proficiency, and resulting agency guidance, national origin discrimination includes discrimination because of limited English proficiency (LEP). To ensure compliance with Title VI, you must take reasonable steps to ensure that LEP persons have meaningful access to your programs (70 Fed. Reg. at 74087 to 74100);
- l. Title IX of the Education Amendments of 1972, as amended, which prohibits you from discriminating because of sex in education programs or activities (20 U.S.C. 1681 et seq).

#### **E. DISADVANTAGED BUSINESS ENTERPRISES**

In the event that the Sponsor has established a Disadvantaged Business Enterprises (DBE) participation goal for the Project which is the subject of this contract, contractor shall comply with all applicable DBE requirements of 49 CFR Part 26. The DBE participation may be composed of any combination of firms certified as DBEs in accordance with 49 CFR Part 26. The contractor shall comply with Sponsor's DBE Program and subcontract with those firms as previously submitted to Sponsor (on form provided by Sponsor) on the contractor's list of disadvantaged businesses to meet the DBE participation goal for this Project. If the contractor intends to subcontract a portion of the services to be performed hereunder, the contractor shall affirmatively seek out DBEs that are potential subcontractors, suppliers, or consultants, and actively solicit their interest, capability and prices. Any questions concerning DBE issues shall be addressed to DBE Program staff at Telephone No. (559) 498-4071 or Fax No. (559) 621-1182.

**Contract Assurance (§ 26.13)** – The contractor or subcontractor shall not discriminate on the basis of race, color, national origin, or sex in the performance of this contract. The contractor shall carry out applicable requirements of 49 CFR Part 26 in the award and administration of DOT assisted contracts. Failure by the contractor to carry out these requirements is a material breach of this contract, which may result in the termination of this contract or such other remedy, as the recipient deems appropriate.

**Prompt Payment (§26.29)** – The contractor agrees to pay each subcontractor under this contract for satisfactory performance of its contract no later than 10 days from the receipt of each payment the contractor receives from Sponsor. The contractor agrees further to return any retainage payments to each subcontractor within 10 days after the subcontractor's work is satisfactorily completed. Any delay or postponement of payment from the above referenced time frame may occur only for good cause following written approval of the Sponsor. This clause applies to both DBE and non-DBE subcontractors.

#### **F. ENERGY CONSERVATION REQUIREMENTS**

Contractor and any subcontractors agree to comply with mandatory standards and policies relating to energy efficiency as contained in the state energy conservation plan

issued in compliance with the Energy Policy and Conservation Act (42 U.S.C. 6201 *et seq.*).

**G. FEDERAL FAIR LABOR STANDARDS ACT (MINIMUM WAGE)**

All contracts and subcontracts resulting from this solicitation incorporate by reference the provisions of 29 CFR part 201, the Federal Fair Labor Standards Act (FLSA), with the same force and effect as if given in full text. The FLSA sets minimum wage, overtime pay, recordkeeping, and child labor standards for full and part time workers.

The contractor has full responsibility to monitor compliance to the referenced statute or regulation. The contractor must address any claims or disputes that arise from this requirement directly with the U.S. Department of Labor – Wage and Hour Division.

**H. OCCUPATIONAL SAFETY AND HEALTH ACT OF 1970**

All contracts and subcontracts that result from this agreement incorporate by reference the requirements of 29 CFR Part 1910 with the same force and effect as if given in full text. Contractor must provide a work environment that is free from recognized hazards that may cause death or serious physical harm to the employee. The Contractor retains full responsibility to monitor its compliance and their subcontractor's compliance with the applicable requirements of the Occupational Safety and Health Act of 1970 (20 CFR Part 1910). Contractor must address any claims or disputes that pertain to a referenced requirement directly with the U.S. Department of Labor – Occupational Safety and Health Administration.

**I. TRADE RESTRICTION CLAUSE**

The contractor or subcontractor, by submission of an offer and/or execution of a contract, certifies that it:

- a. is not owned or controlled by one or more citizens of a foreign country included in the list of countries that discriminate against U.S. firms as published by the Office of the United States Trade Representative (U.S.T.R.);
- b. has not knowingly entered into any contract or subcontract for this project with a person that is a citizen or national of a foreign country included on the list of countries that discriminate against U.S. firms as published by the U.S.T.R.; and
- c. has not entered into any subcontract for any product to be used on the Federal on the project that is produced in a foreign country included on the list of countries that discriminate against U.S. firms published by the U.S.T.R.

This certification concerns a matter within the jurisdiction of an agency of the United States of America and the making of a false, fictitious, or fraudulent certification may render the maker subject to prosecution under Title 18, United States Code, Section 1001.

The contractor must provide immediate written notice to the Sponsor if the contractor learns that its certification or that of a subcontractor was erroneous when submitted or

has become erroneous by reason of changed circumstances. The contractor must require subcontractors provide immediate written notice to the Contractor if at any time it learns that its certification was erroneous by reason of changed circumstances.

Unless the restrictions of this clause are waived by the Secretary of Transportation in accordance with 49 CFR 30.17, no contract shall be awarded to an Sponsor or subcontractor:

- (1) who is owned or controlled by one or more citizens or nationals of a foreign country included on the list of countries that discriminate against U.S. firms published by the U.S.T.R. or
- (2) whose subcontractors are owned or controlled by one or more citizens or nationals of a foreign country on such U.S.T.R. list or
- (3) who incorporates in the public works project any product of a foreign country on such U.S.T.R. list;

Nothing contained in the foregoing shall be construed to require establishment of a system of records in order to render, in good faith, the certification required by this provision. The knowledge and information of a contractor is not required to exceed that which is normally possessed by a prudent person in the ordinary course of business dealings.

The Sponsor agrees that, if awarded a contract resulting from this solicitation, it will incorporate this provision for certification without modification in all lower tier subcontracts. The contractor may rely on the certification of a prospective subcontractor that it is not a firm from a foreign country included on the list of countries that discriminate against U.S. firms as published by U.S.T.R, unless the Sponsor has knowledge that the certification is erroneous.

This certification is a material representation of fact upon which reliance was placed when making an award. If it is later determined that the contractor or subcontractor knowingly rendered an erroneous certification, the Federal Aviation Administration may direct through the Sponsor cancellation of the contract or subcontract for default at no cost to the Sponsor or the FAA.

#### **J. VETERAN'S PREFERENCE**

In the employment of labor (excluding executive, administrative, and supervisory positions), the contractor and all sub-tier contractors must give preference to covered veterans as defined within Title 49 United States Code Section 47112. Covered veterans include Vietnam-era veterans, Persian Gulf veterans, Afghanistan-Iraq war veterans, disabled veterans, and small business concerns (as defined by 15 U.S.C. 632) owned and controlled by disabled veterans. This preference only applies when there are covered veterans readily available and qualified to perform the work to which the employment relates.

**K. SEISMIC SAFETY (applicable to agreements involving design)**

In the performance of design services, the Contractor agrees to furnish a building design and associated construction specification that conform to a building code standard which provides a level of seismic safety substantially equivalent to standards as established by the National Earthquake Hazards Reduction Program (NEHRP). Local building codes that model their building code after the current version of the International Building Code (IBC) meet the NEHRP equivalency level for seismic safety. At the conclusion of the design services, the Contractor agrees to furnish the Sponsor a “certification of compliance” that attests conformance of the building design and the construction specifications with the seismic standards of NEHRP or an equivalent building code.



**II. PROVISIONS APPLICABLE TO LEASES  
VALUED AT \$2,000 AND GREATER**

**A. COPELAND “ANTI-KICKBACK” ACT** (applicable if contract includes construction, alteration, repair, as defined in 29 CFR Part 5)

Contractor must comply with the requirements of the Copeland “Anti-Kickback” Act (18 U.S.C. 874 and 40 U.S.C. 3145), as supplemented by Department of Labor regulation 29 CFR part 3. Contractor and subcontractors are prohibited from inducing, by any means, any person employed on the project to give up any part of the compensation to which the employee is entitled. The Contractor and each Subcontractor must submit to the Sponsor a weekly statement on the wages paid to each employee performing on covered work during the prior week. Sponsor must report any violations of the Act to the Federal Aviation Administration.

**B. DAVIS-BACON REQUIREMENTS** (applicable if contract includes construction, alteration, repair, as defined in 29 CFR Part 5)

**1. Minimum Wages**

(i) All laborers and mechanics employed or working upon the site of the work will be paid unconditionally and not less often than once a week, and without subsequent deduction or rebate on any account (except such payroll deductions as are permitted by the Secretary of Labor under the Copeland Act (29 CFR Part 3)), the full amount of wages and bona fide fringe benefits (or cash equivalent thereof) due at time of payment computed at rates not less than those contained in the wage determination of the Secretary of Labor which is attached hereto and made a part hereof, regardless of any contractual relationship which may be alleged to exist between the contractor and such laborers and mechanics.

Contributions made or costs reasonably anticipated for bona fide fringe benefits under section 1(b)(2) of the Davis-Bacon Act on behalf of laborers or mechanics are considered wages paid to such laborers or mechanics, subject to the provisions of paragraph (1)(iv) of this section; also, regular contributions made or costs incurred for more than a weekly period (but not less often than quarterly) under plans, funds, or programs which cover the particular weekly period, are deemed to be constructively made or incurred during such weekly period. Such laborers and mechanics shall be paid the appropriate wage rate and fringe benefits on the wage determination for the classification of work actually performed, without regard to skill, except as provided in 29 CFR Part 5.5(a)(4). Laborers or mechanics performing work in more than one classification may be compensated at the rate specified for each classification for the time actually worked therein: *Provided*, that the employer's payroll records accurately set forth the time spent in each classification in which work is performed. The wage determination (including any additional classification and wage rates conformed under

(1)(ii) of this section) and the Davis-Bacon poster (WH-1321) shall be posted at all times by the contractor and its subcontractors at the site of the work in a prominent and accessible place where it can easily be seen by the workers.

(ii)(A) The contracting officer shall require that any class of laborers or mechanics, including helpers, which is not listed in the wage determination and which is to be employed under the contract shall be classified in conformance with the wage determination. The contracting officer shall approve an additional classification and wage rate and fringe benefits therefore only when the following criteria have been met:

(1) The work to be performed by the classification requested is not performed by a classification in the wage determination; and

(2) The classification is utilized in the area by the construction industry; and

(3) The proposed wage rate, including any bona fide fringe benefits, bears a reasonable relationship to the wage rates contained in the wage determination.

(B) If the contractor and the laborers and mechanics to be employed in the classification (if known), or their representatives, and the contracting officer agree on the classification and wage rate (including the amount designated for fringe benefits where appropriate), a report of the action taken shall be sent by the contracting officer to the Administrator of the Wage and Hour Division, Employment Standards Administration, U.S. Department of Labor, Washington, D.C. 20210. The Administrator, or an authorized representative, will approve, modify, or disapprove every additional classification action within 30 days of receipt and so advise the contracting officer or will notify the contracting officer within the 30-day period that additional time is necessary.

(C) In the event the contractor, the laborers or mechanics to be employed in the classification or their representatives, and the contracting officer do not agree on the proposed classification and wage rate (including the amount designated for fringe benefits where appropriate), the contracting officer shall refer the questions, including the views of all interested parties and the recommendation of the contracting officer, to the Administrator for determination. The Administrator, or an authorized representative, will issue a determination within 30 days of receipt and so advise the contracting officer or will notify the contracting officer within the 30-day period that additional time is necessary.

(D) The wage rate (including fringe benefits where appropriate) determined pursuant to subparagraphs (1)(ii) (B) or (C) of this paragraph, shall be paid to all workers performing work in the classification under this contract from the first day on which work is performed in the classification.

(iii) Whenever the minimum wage rate prescribed in the contract for a class of laborers or mechanics includes a fringe benefit which is not expressed as an hourly rate, the contractor shall either pay the benefit as stated in the wage determination or shall pay another bona fide fringe benefit or an hourly cash equivalent thereof.

(iv) If the contractor does not make payments to a trustee or other third person, the contractor may consider as part of the wages of any laborer or mechanic the amount of any costs reasonably anticipated in providing bona fide fringe benefits under a plan or program, *Provided*, That the Secretary of Labor has found, upon the written request of the contractor, that the applicable standards of the Davis-Bacon Act have been met. The Secretary of Labor may require the contractor to set aside in a separate account assets for the meeting of obligations under the plan or program.

## **2. Withholding.**

The Federal Aviation Administration or the sponsor shall upon its own action or upon written request of an authorized representative of the Department of Labor withhold or cause to be withheld from the contractor under this contract or any other Federal contract with the same prime contractor, or any other Federally-assisted contract subject to Davis-Bacon prevailing wage requirements, which is held by the same prime contractor, so much of the accrued payments or advances as may be considered necessary to pay laborers and mechanics, including apprentices, trainees, and helpers, employed by the contractor or any subcontractor the full amount of wages required by the contract. In the event of failure to pay any laborer or mechanic, including any apprentice, trainee, or helper, employed or working on the site of work, all or part of the wages required by the contract, the Federal Aviation Administration may, after written notice to the contractor, sponsor, applicant, or owner, take such action as may be necessary to cause the suspension of any further payment, advance, or guarantee of funds until such violations have ceased.

## **3. Payrolls and basic records.**

(i) Payrolls and basic records relating thereto shall be maintained by the contractor during the course of the work and preserved for a period of three years thereafter for all laborers and mechanics working at the site of the work. Such records shall contain the name, address, and social security number of each such worker, his or her correct classification, hourly rates of wages paid (including rates of contributions or costs anticipated for bona fide fringe benefits or cash equivalents thereof of the types described in 1(b)(2)(B) of the Davis-Bacon Act), daily and weekly number of hours worked, deductions made and actual wages paid. Whenever the Secretary of Labor has found under 29 CFR 5.5(a)(1)(iv) that the wages of any laborer or mechanic include the amount of any costs reasonably anticipated in providing benefits under a plan or program described in section 1(b)(2)(B) of the Davis-Bacon Act, the contractor shall maintain records which show that the commitment to provide such benefits is

enforceable, that the plan or program is financially responsible, and that the plan or program has been communicated in writing to the laborers or mechanics affected, and records which show the costs anticipated or the actual costs incurred in providing such benefits. Contractors employing apprentices or trainees under approved programs shall maintain written evidence of the registration of apprenticeship programs and certification of trainee programs, the registration of the apprentices and trainees, and the ratios and wage rates prescribed in the applicable programs.

(ii)(A) The contractor shall submit weekly for each week in which any contract work is performed a copy of all payrolls to the Federal Aviation Administration if the agency is a party to the contract, but if the agency is not such a party, the contractor will submit the payrolls to the applicant, sponsor, or owner, as the case may be, for transmission to the Federal Aviation Administration. The payrolls submitted shall set out accurately and completely all of the information required to be maintained under 29 CFR 5.5(a)(3)(i), except that full social security numbers and home addresses shall not be included on weekly transmittals. Instead the payrolls shall only need to include an individually identifying number for each employee (e.g., the last four digits of the employee's social security number). The required weekly payroll information may be submitted in any form desired. Optional Form WH-347 is available for this purpose from the Wage and Hour Division Web site at <http://www.dol.gov/esa/whd/forms/wh347instr.htm> or its successor site. The prime contractor is responsible for the submission of copies of payrolls by all subcontractors. Contractors and subcontractors shall maintain the full social security number and current address of each covered worker, and shall provide them upon request to the Federal Aviation Administration if the agency is a party to the contract, but if the agency is not such a party, the contractor will submit them to the applicant, sponsor, or owner, as the case may be, for transmission to the Federal Aviation Administration, the contractor, or the Wage and Hour Division of the Department of Labor for purposes of an investigation or audit of compliance with prevailing wage requirements. It is not a violation of this section for a prime contractor to require a subcontractor to provide addresses and social security numbers to the prime contractor for its own records, without weekly submission to the sponsoring government agency (or the applicant, sponsor, or owner).

(B) Each payroll submitted shall be accompanied by a "Statement of Compliance," signed by the contractor or subcontractor or his or her agent who pays or supervises the payment of the persons employed under the contract and shall certify the following:

(1) That the payroll for the payroll period contains the information required to be provided under 29 CFR § 5.5(a)(3)(ii), the appropriate information is being maintained under 29 CFR § 5.5 (a)(3)(i) and that such information is correct and complete;

(2) That each laborer and mechanic (including each helper, apprentice and trainee) employed on the contract during the payroll period has been paid the full weekly wages earned, without rebate, either directly or indirectly, and that no deductions have been made either directly or indirectly from the full wages earned, other than permissible deductions as set forth in Regulations 29 CFR Part 3;

(3) That each laborer or mechanic has been paid not less than the applicable wage rates and fringe benefits or cash equivalents for the classification of work performed, as specified in the applicable wage determination incorporated into the contract.

(C) The weekly submission of a properly executed certification set forth on the reverse side of Optional Form WH-347 shall satisfy the requirement for submission of the "Statement of Compliance" required by paragraph (3)(ii)(B) of this section.

(D) The falsification of any of the above certifications may subject the contractor or subcontractor to civil or criminal prosecution under Section 1001 of Title 18 and Section 231 of Title 31 of the United States Code.

(iii) The contractor or subcontractor shall make the records required under paragraph (3)(i) of this section available for inspection, copying or transcription by authorized representatives of the sponsor, the Federal Aviation Administration or the Department of Labor, and shall permit such representatives to interview employees during working hours on the job. If the contractor or subcontractor fails to submit the required records or to make them available, the Federal agency may, after written notice to the contractor, sponsor, applicant or owner, take such action as may be necessary to cause the suspension of any further payment, advance, or guarantee of funds. Furthermore, failure to submit the required records upon request or to make such records available may be grounds for debarment action pursuant to 29 CFR 5.12.

#### **4. Apprentices and Trainees.**

(i) Apprentices. Apprentices will be permitted to work at less than the predetermined rate for the work they performed when they are employed pursuant to and individually registered in a bona fide apprenticeship program registered with the U.S. Department of Labor, Employment and Training Administration, Bureau of Apprenticeship and Training, or with a State Apprenticeship Agency recognized by the Bureau, or if a person is employed in his or her first 90 days of probationary employment as an apprentice in such an apprenticeship program, who is not individually registered in the program, but who has been certified by the Bureau of Apprenticeship and Training or a State Apprenticeship Agency (where appropriate) to be eligible for probationary employment as an apprentice. The allowable ratio of apprentices to journeymen on the job site in any craft classification shall not be greater than the ratio permitted to the contractor as to the entire work force under the registered program. Any worker listed on a payroll at an apprentice wage rate, who is not registered or otherwise employed

as stated above, shall be paid not less than the applicable wage rate on the wage determination for the classification of work actually performed. In addition, any apprentice performing work on the job site in excess of the ratio permitted under the registered program shall be paid not less than the applicable wage rate on the wage determination for the work actually performed. Where a contractor is performing construction on a project in a locality other than that in which its program is registered, the ratios and wage rates (expressed in percentages of the journeyman's hourly rate) specified in the contractor's or subcontractor's registered program shall be observed. Every apprentice must be paid at not less than the rate specified in the registered program for the apprentice's level of progress, expressed as a percentage of the journeymen hourly rate specified in the applicable wage determination. Apprentices shall be paid fringe benefits in accordance with the provisions of the apprenticeship program. If the apprenticeship program does not specify fringe benefits, apprentices must be paid the full amount of fringe benefits listed on the wage determination for the applicable classification. If the Administrator determines that a different practice prevails for the applicable apprentice classification, fringes shall be paid in accordance with that determination. In the event the Bureau of Apprenticeship and Training, or a State Apprenticeship Agency recognized by the Bureau, withdraws approval of an apprenticeship program, the contractor will no longer be permitted to utilize apprentices at less than the applicable predetermined rate for the work performed until an acceptable program is approved.

(ii) Trainees. Except as provided in 29 CFR 5.16, trainees will not be permitted to work at less than the predetermined rate for the work performed unless they are employed pursuant to and individually registered in a program which has received prior approval, evidenced by formal certification by the U.S. Department of Labor, Employment and Training Administration. The ratio of trainees to journeymen on the job site shall not be greater than permitted under the plan approved by the Employment and Training Administration. Every trainee must be paid at not less than the rate specified in the approved program for the trainee's level of progress, expressed as a percentage of the journeyman hourly rate specified in the applicable wage determination. Trainees shall be paid fringe benefits in accordance with the provisions of the trainee program. If the trainee program does not mention fringe benefits, trainees shall be paid the full amount of fringe benefits listed on the wage determination unless the Administrator of the Wage and Hour Division determines that there is an apprenticeship program associated with the corresponding journeyman wage rate on the wage determination which provides for less than full fringe benefits for apprentices. Any employee listed on the payroll at a trainee rate that is not registered and participating in a training plan approved by the Employment and Training Administration shall be paid not less than the applicable wage rate on the wage determination for the classification of work actually performed. In addition, any trainee performing work on the job site in excess

of the ratio permitted under the registered program shall be paid not less than the applicable wage rate on the wage determination for the work actually performed. In the event the Employment and Training Administration withdraws approval of a training program, the contractor will no longer be permitted to utilize trainees at less than the applicable predetermined rate for the work performed until an acceptable program is approved.

(iii) Equal Employment Opportunity. The utilization of apprentices, trainees and journeymen under this part shall be in conformity with the equal employment opportunity requirements of Executive Order 11246, as amended, and 29 CFR Part 30.

#### **5. Compliance with Copeland Act Requirements.**

The contractor shall comply with the requirements of 29 CFR Part 3, which are incorporated by reference in this contract.

#### **6. Subcontracts.**

The contractor or subcontractor shall insert in any subcontracts the clauses contained in 29 CFR Part 5.5(a)(1) through (10) and such other clauses as the Federal Aviation Administration may by appropriate instructions require, and also a clause requiring the subcontractors to include these clauses in any lower tier subcontracts. The prime contractor shall be responsible for the compliance by any subcontractor or lower tier subcontractor with all the contract clauses in 29 CFR Part 5.5.

#### **7. Contract Termination: Debarment.**

A breach of the contract clauses in paragraph 1 through 10 of this section may be grounds for termination of the contract, and for debarment as a contractor and a subcontractor as provided in 29 CFR 5.12.

#### **8. Compliance With Davis-Bacon and Related Act Requirements.**

All rulings and interpretations of the Davis-Bacon and Related Acts contained in 29 CFR Parts 1, 3, and 5 are herein incorporated by reference in this contract.

#### **9. Disputes Concerning Labor Standards.**

Disputes arising out of the labor standards provisions of this contract shall not be subject to the general disputes clause of this contract. Such disputes shall be resolved in accordance with the procedures of the Department of Labor set forth in 29 CFR Parts 5, 6 and 7. Disputes within the meaning of this clause include disputes between the contractor (or any of its subcontractors) and the contracting agency, the U.S. Department of Labor, or the employees or their representatives.

#### **10. Certification of Eligibility.**

(i) By entering into this contract, the contractor certifies that neither it (nor he or she) nor any person or firm who has an interest in the contractor's firm is a person or firm ineligible to be awarded Government contracts by virtue of section 3(a) of the Davis-Bacon Act or 29 CFR 5.12(a)(1).

(ii) No part of this contract shall be subcontracted to any person or firm ineligible for award of a Government contract by virtue of section 3(a) of the Davis-Bacon Act or 29 CFR 5.12(a)(1).

(iii) The penalty for making false statements is prescribed in the U.S. Criminal Code, 18 U.S.C. 1001.



**III. PROVISION APPLICABLE TO LEASES  
\$3,000 AND GREATER**

**A. BAN ON TEXTING AND DRIVING**

The contractor shall adopt and enforce workplace safety policies to decrease crashes caused by distracted drivers, including policies to ban text messaging while driving when performing any work for, or on behalf of, the Federal government. The contractor further agrees to conduct workplace safety initiatives commensurate with the size of its business, such as establishing rules or programs that prohibit text messaging while driving and education, awareness, and other outreach to employees about the safety risks associated with texting while driving.

**IV. PROVISIONS APPLICABLE TO LEASES  
\$10,000 AND GREATER**

**A. AFFIRMATIVE ACTION REQUIREMENT** (applicable to contracts and subcontracts exceeding \$10,000 and including AIP-funded construction work. "Construction work" means construction, rehabilitation, alteration, conversion, extension, demolition or repair of buildings, highways, or other changes or improvements to real property, including facilities providing utility services. The term also includes the supervision, inspection, and other onsite functions incidental to the actual construction.)

1. The Offeror's or Bidder's attention is called to the "Equal Opportunity Clause" and the "Standard Federal Equal Employment Opportunity Construction Contract Specifications" set forth herein.
2. The goals and timetables for minority and female participation, expressed in percentage terms for the contractor's aggregate workforce in each trade on all construction work in the covered area, are as follows:

**Timetables**

Goals for minority participation for each trade: 26.1%

Goals for female participation in each trade: 6.9%

These goals are applicable to all of the contractor's construction work (whether or not it is Federal or federally-assisted) performed in the covered area. If the contractor performs construction work in a geographical area located outside of the covered area, it shall apply the goals established for such geographical area where the work is actually performed. With regard to this second area, the contractor also is subject to the goals for both its federally involved and non-federally involved construction.

The Contractor's compliance with the Executive Order and the regulations in 41 CFR Part 60-4 shall be based on its implementation of the Equal Opportunity Clause, specific affirmative action obligations required by the specifications set forth in 41 CFR 60-4.3(a), and its efforts to meet the goals. The hours of minority and female employment and training must be substantially uniform throughout the length of the contract, and in each trade, and the contractor shall make a good faith effort to employ minorities and women evenly on each of its projects. The transfer of minority or female employees or trainees from Contractor to Contractor or from project to project for the sole purpose of meeting the Contractor's goals shall be a violation of the contract, the Executive Order and the regulations in 41 CFR Part 60-4. Compliance with the goals will be measured against the total work hours performed.

3. The Contractor shall provide written notification to the Director of the Office of Federal Contract Compliance Programs (OFCCP) within 10 working days of award of any construction subcontract in excess of \$10,000 at any tier for construction work

under the contract resulting from this solicitation. The notification shall list the name, address, and telephone number of the subcontractor; employer identification number of the subcontractor; estimated dollar amount of the subcontract; estimated starting and completion dates of the subcontract; and the geographical area in which the subcontract is to be performed.

4. As used in this notice and in the contract resulting from this solicitation, the "covered area" is the State of California, County of Fresno, City of Fresno.

**B. EQUAL EMPLOYMENT OPPORTUNITY (E.E.O)** (applicable to construction contracts, as defined in the Affirmative Action provision, over \$10,000)

**1. EQUAL OPPORTUNITY CLAUSE**

During the performance of this contract, the contractor agrees as follows:

(1) The contractor will not discriminate against any employee or applicant for employment because of race, color, religion, sex, or national origin. The contractor will take affirmative action to ensure that applicants are employed, and that employees are treated during employment without regard to their race, color, religion, sex, sexual orientation, gender identify or national origin. Such action shall include, but not be limited to the following: employment, upgrading, demotion, or transfer; recruitment or recruitment advertising; layoff or termination; rates of pay or other forms of compensation; and selection for training, including apprenticeship. The contractor agrees to post in conspicuous places, available to employees and applicants for employment, notices to be provided setting forth the provisions of this nondiscrimination clause.

(2) The contractor will, in all solicitations or advertisements for employees placed by or on behalf of the contractor, state that all qualified applicants will receive considerations for employment without regard to race, color, religion, sex, or national origin.

(3) The contractor will send to each labor union or representative of workers with which he has a collective bargaining agreement or other contract or understanding, a notice to be provided advising the said labor union or workers' representatives of the contractor's commitments under this section, and shall post copies of the notice in conspicuous places available to employees and applicants for employment.

(4) The contractor will comply with all provisions of Executive Order 11246 of September 24, 1965, and of the rules, regulations, and relevant orders of the Secretary of Labor.

(5) The contractor will furnish all information and reports required by Executive Order 11246 of September 24, 1965, and by rules, regulations, and orders of the Secretary of Labor, or pursuant thereto, and will permit access to his books, records, and

accounts by the administering agency and the Secretary of Labor for purposes of investigation to ascertain compliance with such rules, regulations, and orders.

(6) In the event of the contractor's noncompliance with the nondiscrimination clauses of this contract or with any of the said rules, regulations, or orders, this contract may be canceled, terminated, or suspended in whole or in part and the contractor may be declared ineligible for further Government contracts or federally assisted construction contracts in accordance with procedures authorized in Executive Order 11246 of September 24, 1965, and such other sanctions may be imposed and remedies invoked as provided in Executive Order 11246 of September 24, 1965, or by rule, regulation, or order of the Secretary of Labor, or as otherwise provided by law.

(7) The contractor will include the portion of the sentence immediately preceding paragraph (1) and the provisions of paragraphs (1) through (7) in every subcontract or purchase order unless exempted by rules, regulations, or orders of the Secretary of Labor issued pursuant to section 204 of Executive Order 11246 of September 24, 1965, so that such provisions will be binding upon each subcontractor or vendor. The contractor will take such action with respect to any subcontract or purchase order as the administering agency may direct as a means of enforcing such provisions, including sanctions for noncompliance: *Provided, however,* That in the event a contractor becomes involved in, or is threatened with, litigation with a subcontractor or vendor as a result of such direction by the administering agency the contractor may request the United States to enter into such litigation to protect the interests of the United States.

## **2. STANDARD FEDERAL EQUAL EMPLOYMENT OPPORTUNITY CONSTRUCTION CONTRACT SPECIFICATIONS**

1. As used in these specifications:

- a. "Covered area" means the geographical area described in the solicitation from which this contract resulted;
- b. "Director" means Director, Office of Federal Contract Compliance Programs (OFCCP), U.S. Department of Labor, or any person to whom the Director delegates authority;
- c. "Employer identification number" means the Federal social security number used on the Employer's Quarterly Federal Tax Return, U.S. Treasury Department Form 941;
- d. "Minority" includes:
  - (1) Black (all) persons having origins in any of the Black African racial groups not of Hispanic origin);

(2) Hispanic (all persons of Mexican, Puerto Rican, Cuban, Central or South American, or other Spanish culture or origin regardless of race);

(3) Asian and Pacific Islander (all persons having origins in any of the original peoples of the Far East, Southeast Asia, the Indian Subcontinent, or the Pacific Islands); and

(4) American Indian or Alaskan native (all persons having origins in any of the original peoples of North America and maintaining identifiable tribal affiliations through membership and participation or community identification).

2. Whenever the contractor, or any subcontractor at any tier, subcontracts a portion of the work involving any construction trade, it shall physically include in each subcontract in excess of \$10,000 the provisions of these specifications and the Notice which contains the applicable goals for minority and female participation and which is set forth in the solicitations from which this contract resulted.

3. If the contractor is participating (pursuant to 41 CFR 60-4.5) in a Hometown Plan approved by the U.S. Department of Labor in the covered area either individually or through an association, its affirmative action obligations on all work in the Plan area (including goals and timetables) shall be in accordance with that Plan for those trades which have unions participating in the Plan. Contractors shall be able to demonstrate their participation in and compliance with the provisions of any such Hometown Plan. Each contractor or subcontractor participating in an approved plan is individually required to comply with its obligations under the EEO clause and to make a good faith effort to achieve each goal under the Plan in each trade in which it has employees. The overall good faith performance by other contractors or subcontractors toward a goal in an approved Plan does not excuse any covered contractor's or subcontractor's failure to take good faith efforts to achieve the Plan goals and timetables.

4. The contractor shall implement the specific affirmative action standards provided in paragraphs 7a through 7p of these specifications. The goals set forth in the solicitation from which this contract resulted are expressed as percentages of the total hours of employment and training of minority and female utilization the contractor should reasonably be able to achieve in each construction trade in which it has employees in the covered area. Covered construction contractors performing construction work in a geographical area where they do not have a Federal or federally assisted construction contract shall apply the minority and female goals established for the geographical area where the work is being performed. Goals are published periodically in the Federal Register in notice form, and such notices may be obtained from any Office of Federal Contract Compliance Programs office or from Federal procurement contracting officers. The contractor is expected to make substantially uniform progress in meeting its goals in each craft during the period specified.

5. Neither the provisions of any collective bargaining agreement nor the failure by a union with whom the contractor has a collective bargaining agreement to refer either minorities or women shall excuse the contractor's obligations under these specifications, Executive Order 11246 or the regulations promulgated pursuant thereto.

6. In order for the non-working training hours of apprentices and trainees to be counted in meeting the goals, such apprentices and trainees shall be employed by the contractor during the training period and the contractor shall have made a commitment to employ the apprentices and trainees at the completion of their training, subject to the availability of employment opportunities. Trainees shall be trained pursuant to training programs approved by the U.S. Department of Labor.

7. The contractor shall take specific affirmative actions to ensure equal employment opportunity. The evaluation of the contractor's compliance with these specifications shall be based upon its effort to achieve maximum results from its actions. The contractor shall document these efforts fully and shall implement affirmative action steps at least as extensive as the following:

a. Ensure and maintain a working environment free of harassment, intimidation, and coercion at all sites, and in all facilities at which the contractor's employees are assigned to work. The contractor, where possible, will assign two or more women to each construction project. The contractor shall specifically ensure that all foremen, superintendents, and other onsite supervisory personnel are aware of and carry out the contractor's obligation to maintain such a working environment, with specific attention to minority or female individuals working at such sites or in such facilities.

b. Establish and maintain a current list of minority and female recruitment sources, provide written notification to minority and female recruitment sources and to community organizations when the contractor or its unions have employment opportunities available, and maintain a record of the organizations' responses.

c. Maintain a current file of the names, addresses, and telephone numbers of each minority and female off-the-street applicant and minority or female referral from a union, a recruitment source, or community organization and of what action was taken with respect to each such individual. If such individual was sent to the union hiring hall for referral and was not referred back to the contractor by the union or, if referred, not employed by the contractor, this shall be documented in the file with the reason therefore along with whatever additional actions the contractor may have taken.

d. Provide immediate written notification to the Director when the union or unions with which the contractor has a collective bargaining agreement has not referred to

the contractor a minority person or female sent by the contractor, or when the contractor has other information that the union referral process has impeded the contractor's efforts to meet its obligations.

e. Develop on-the-job training opportunities and/or participate in training programs for the area which expressly include minorities and women, including upgrading programs and apprenticeship and trainee programs relevant to the contractor's employment needs, especially those programs funded or approved by the Department of Labor. The contractor shall provide notice of these programs to the sources compiled under 7b above.

f. Disseminate the contractor's EEO policy by providing notice of the policy to unions and training programs and requesting their cooperation in assisting the contractor in meeting its EEO obligations; by including it in any policy manual and collective bargaining agreement; by publicizing it in the company newspaper, annual report, etc.; by specific review of the policy with all management personnel and with all minority and female employees at least once a year; and by posting the company EEO policy on bulletin boards accessible to all employees at each location where construction work is performed.

g. Review, at least annually, the company's EEO policy and affirmative action obligations under these specifications with all employees having any responsibility for hiring, assignment, layoff, termination, or other employment decisions including specific review of these items with onsite supervisory personnel such as superintendents, general foremen, etc., prior to the initiation of construction work at any job site. A written record shall be made and maintained identifying the time and place of these meetings, persons attending, subject matter discussed, and disposition of the subject matter.

h. Disseminate the contractor's EEO policy externally by including it in any advertising in the news media, specifically including minority and female news media, and providing written notification to and discussing the contractor's EEO policy with other contractors and subcontractors with whom the contractor does or anticipates doing business.

i. Direct its recruitment efforts, both oral and written, to minority, female, and community organizations, to schools with minority and female students; and to minority and female recruitment and training organizations serving the contractor's recruitment area and employment needs. Not later than one month prior to the date for the acceptance of applications for apprenticeship or other training by any recruitment source, the contractor shall send written notification to organizations, such as the above, describing the openings, screening procedures, and tests to be used in the selection process.

j. Encourage present minority and female employees to recruit other minority persons and women and, where reasonable, provide after school, summer, and vacation employment to minority and female youth both on the site and in other areas of a contractor's workforce.

k. Validate all tests and other selection requirements where there is an obligation to do so under 41 CFR Part 60-3.

l. Conduct, at least annually, an inventory and evaluation at least of all minority and female personnel, for promotional opportunities and encourage these employees to seek or to prepare for, through appropriate training, etc., such opportunities.

m. Ensure that seniority practices, job classifications, work assignments, and other personnel practices do not have a discriminatory effect by continually monitoring all personnel and employment related activities to ensure that the EEO policy and the contractor's obligations under these specifications are being carried out.

n. Ensure that all facilities and company activities are non-segregated except that separate or single user toilet and necessary changing facilities shall be provided to assure privacy between the sexes.

o. Document and maintain a record of all solicitations of offers for subcontracts from minority and female construction contractors and suppliers, including circulation of solicitations to minority and female contractor associations and other business associations.

p. Conduct a review, at least annually, of all supervisor's adherence to and performance under the contractor's EEO policies and affirmative action obligations.

8. Contractors are encouraged to participate in voluntary associations, which assist in fulfilling one or more of their affirmative action obligations (7a through 7p). The efforts of a contractor association, joint contractor union, contractor community, or other similar groups of which the contractor is a member and participant, may be asserted as fulfilling any one or more of its obligations under 7a through 7p of these specifications provided that the contractor actively participates in the group, makes every effort to assure that the group has a positive impact on the employment of minorities and women in the industry, ensures that the concrete benefits of the program are reflected in the contractor's minority and female workforce participation, makes a good faith effort to meet its individual goals and timetables, and can provide access to documentation which demonstrates the effectiveness of actions taken on behalf of the contractor. The obligation to comply, however, is the contractor's and failure of such a group to fulfill an obligation shall not be a defense for the contractor's noncompliance.



9. A single goal for minorities and a separate single goal for women have been established. The contractor, however, is required to provide equal employment opportunity and to take affirmative action for all minority groups, both male and female, and all women, both minority and non-minority. Consequently, if the particular group is employed in a substantially disparate manner (for example, even though the contractor has achieved its goals for women generally,) the contractor may be in violation of the Executive Order if a specific minority group of women is underutilized.

10. The contractor shall not use the goals and timetables or affirmative action standards to discriminate against any person because of race, color, religion, sex, or national origin.

11. The contractor shall not enter into any subcontract with any person or firm debarred from Government contracts pursuant to Executive Order 11246.

12. The contractor shall carry out such sanctions and penalties for violation of these specifications and of the Equal Opportunity Clause, including suspension, termination, and cancellation of existing subcontracts as may be imposed or ordered pursuant to Executive Order 11246, as amended, and its implementing regulations, by the Office of Federal Contract Compliance Programs. Any contractor who fails to carry out such sanctions and penalties shall be in violation of these specifications and Executive Order 11246, as amended.

13. The contractor, in fulfilling its obligations under these specifications, shall implement specific affirmative action steps, at least as extensive as those standards prescribed in paragraph 7 of these specifications, so as to achieve maximum results from its efforts to ensure equal employment opportunity. If the contractor fails to comply with the requirements of the Executive Order, the implementing regulations, or these specifications, the Director shall proceed in accordance with 41 CFR 60-4.8.

14. The contractor shall designate a responsible official to monitor all employment related activity to ensure that the company EEO policy is being carried out, to submit reports relating to the provisions hereof as may be required by the Government, and to keep records. Records shall at least include for each employee, the name, address, telephone number, construction trade, union affiliation if any, employee identification number when assigned, social security number, race, sex, status (e.g., mechanic, apprentice, trainee, helper, or laborer), dates of changes in status, hours worked per week in the indicated trade, rate of pay, and locations at which the work was performed. Records shall be maintained in an easily understandable and retrievable form; however, to the degree that existing records satisfy this requirement, contractors shall not be required to maintain separate records.

15. Nothing herein provided shall be construed as a limitation upon the application of other laws which establish different standards of compliance or upon the application of

requirements for the hiring of local or other area residents (e.g., those under the Public Works Employment Act of 1977 and the Community Development Block Grant Program).

**C. PROHIBITION of SEGREGATED FACILITIES** (applicable to contracts and subcontracts exceeding \$10,000 and including AIP-funded construction work. "Construction work" means construction, rehabilitation, alteration, conversion, extension, demolition or repair of buildings, highways, or other changes or improvements to real property, including facilities providing utility services. The term also includes the supervision, inspection, and other onsite functions incidental to the actual construction.)

(a) The Contractor agrees that it does not and will not maintain or provide for its employees any segregated facilities at any of its establishments, and that it does not and will not permit its employees to perform their services at any location under its control where segregated facilities are maintained. The Contractor agrees that a breach of this clause is a violation of the Equal Opportunity clause in this contract.

(b) "Segregated facilities," as used in this clause, means any waiting rooms, work areas, rest rooms and wash rooms, restaurants and other eating areas, time clocks, locker rooms and other storage or dressing areas, parking lots, drinking fountains, recreation or entertainment areas, transportation, and housing facilities provided for employees, that are segregated by explicit directive or are in fact segregated on the basis of race, color, religion, sex, or national origin because of written or oral policies or employee custom. The term does not include separate or single-user rest rooms or necessary dressing or sleeping areas provided to assure privacy between the sexes.

(c) The Contractor shall include this clause in every subcontract and purchase order that is subject to the Equal Opportunity clause of this contract.

**D. PROCUREMENT OF RECOVERED MATERIALS** (applicable if an agreement includes procurement of a product that exceeds \$10,000)

Contractor and subcontractor agree to comply with Section 6002 of the Solid Waste Disposal Act, as amended by the Resource Conservation and Recovery Act, and the regulatory provisions of 40 CFR Part 247. In the performance of this contract and to the extent practicable, the Contractor and subcontractors are to use of products containing the highest percentage of recovered materials for items designated by the Environmental Protection Agency (EPA) under 40 CFR Part 247 whenever:

- a) The contract requires procurement of \$10,000 or more of a designated item during the fiscal year; or,
- b) The contractor has procured \$10,000 or more of a designated item using Federal funding during the previous fiscal year.

The list of EPA-designated items is available at [www.epa.gov/epawaste/conserve/tools/cpg/products/](http://www.epa.gov/epawaste/conserve/tools/cpg/products/). Section 6002(c) establishes exceptions to the preference for recovery of EPA-designated products if the contractor can demonstrate the item is:

- a) Not reasonably available within a timeframe providing for compliance with the contract performance schedule;
- b) Fails to meet reasonable contract performance requirements; or
- c) Is only available at an unreasonable price.

## **E. TERMINATION OF CONTRACT**

### **1. TERMINATION FOR CONVENIENCE**

The Sponsor may, by written notice to the Contractor, terminate this Agreement for its convenience and without cause or default on the part of Contractor. Upon receipt of the notice of termination, except as explicitly directed by the Sponsor, the Contractor must immediately discontinue all services affected.

Upon termination of the Agreement, the Contractor must deliver to the Sponsor all data, surveys, models, drawings, specifications, reports, maps, photographs, estimates, summaries, and other documents and materials prepared by the Engineer under this contract, whether complete or partially complete.

Sponsor agrees to make just and equitable compensation to the Contractor for satisfactory work completed up through the date the Contractor receives the termination notice. Compensation will not include anticipated profit on non-performed services.

Sponsor further agrees to hold Contractor harmless for errors or omissions in documents that are incomplete as a result of the termination action under this clause.

### **2. TERMINATION FOR DEFAULT**

Either party may terminate this Agreement for cause if the other party fails to fulfill its obligations that are essential to the completion of the work per the terms and conditions of the Agreement. The party initiating the termination action must allow the breaching party an opportunity to dispute or cure the breach.

The terminating party must provide the breaching party [7] days advance written notice of its intent to terminate the Agreement. The notice must specify the nature and extent of the breach, the conditions necessary to cure the breach, and the effective date of the termination action. The rights and remedies in this clause are in addition to any other rights and remedies provided by law or under this agreement.

- a) **Termination by Sponsor:** The Sponsor may terminate this Agreement in whole or in part, for the failure of the Contractor to:

- i) Perform the services within the time specified in this contract or by Sponsor approved extension;
- ii) Make adequate progress so as to endanger satisfactory performance of the Project;
- iii) Fulfill the obligations of the Agreement that are essential to the completion of the Project.

Upon receipt of the notice of termination, the Contractor must immediately discontinue all services affected unless the notice directs otherwise. Upon termination of the Agreement, the Contractor must deliver to the Sponsor all data, surveys, models, drawings, specifications, reports, maps, photographs, estimates, summaries, and other documents and materials prepared by the Engineer under this contract, whether complete or partially complete.

Sponsor agrees to make just and equitable compensation to the Contractor for satisfactory work completed up through the date the Contractor receives the termination notice. Compensation will not include anticipated profit on non-performed services.

Sponsor further agrees to hold Contractor harmless for errors or omissions in documents that are incomplete as a result of the termination action under this clause.

If, after finalization of the termination action, the Sponsor determines the Contractor was not in default of the Agreement, the rights and obligations of the parties shall be the same as if the Sponsor issued the termination for the convenience of the Sponsor.

- b) **Termination by Contractor:** The Contractor may terminate this Agreement in whole or in part, if the Sponsor:
- i) Defaults on its obligations under this Agreement;
  - ii) Fails to make payment to the Contractor in accordance with the terms of this Agreement;
  - iii) Suspends the Project for more than [180] days due to reasons beyond the control of the Contractor.

Upon receipt of a notice of termination from the Contractor, Sponsor agrees to cooperate with Contractor for the purpose of terminating the agreement or portion thereof, by mutual consent. If Sponsor and Contractor cannot reach mutual agreement on the termination settlement, the Contractor may, without prejudice to any rights and remedies it may have, proceed with terminating all or parts of this Agreement based upon the Sponsor's breach of the contract.

In the event of termination due to Sponsor breach, the Engineer is entitled to invoice Sponsor and to receive full payment for all services performed or furnished in accordance with this Agreement and all justified reimbursable expenses incurred by the Contractor through the effective date of termination action. Sponsor agrees

to hold Contractor harmless for errors or omissions in documents that are incomplete as a result of the termination action under this clause.

**V. PROVISION APPLICABLE TO LEASES  
\$25,000 AND GREATER**

**A. CERTIFICATIONS REGARDING DEBARMENT AND SUSPENSION**

**1. CERTIFICATE REGARDING DEBARMENT AND SUSPENSION (BIDDER OR OFFEROR)**

By submitting a bid/proposal under this solicitation, the bidder or offeror certifies that at the time the bidder or offeror submits its proposal that neither it nor its principals are presently debarred or suspended by any Federal department or agency from participation in this transaction.

**2. CERTIFICATION REGARDING DEBARMENT AND SUSPENSION  
(SUCCESSFUL BIDDER REGARDING LOWER TIER PARTICIPANTS)**

The successful bidder, by administering each lower tier subcontract that exceeds \$25,000 as a “covered transaction”, must verify each lower tier participant of a “covered transaction” under the project is not presently debarred or otherwise disqualified from participation in this federally assisted project. The successful bidder will accomplish this by:

1. Checking the System for Award Management at website: <http://www.sam.gov>
2. Collecting a certification statement similar to the Certificate Regarding Debarment and Suspension (Bidder or Offeror), above.
3. Inserting a clause or condition in the covered transaction with the lower tier contract

If the FAA later determines that a lower tier participant failed to tell a higher tier that it was excluded or disqualified at the time it entered the covered transaction, the FAA may pursue any available remedy, including suspension and debarment of the non-compliant participant.

**V. PROVISIONS APPLICABLE TO LEASES  
\$100,000 AND GREATER**

**A. CONTRACT WORK HOURS AND SAFETY STANDARDS ACT REQUIREMENTS** (applicable to contracts employing laborers, mechanics, watchmen and guards, or installing equipment onsite)

1. Overtime Requirements.

No contractor or subcontractor contracting for any part of the contract work which may require or involve the employment of laborers or mechanics shall require or permit any such laborer or mechanic, including watchmen and guards, in any workweek in which he or she is employed on such work to work in excess of forty hours in such workweek unless such laborer or mechanic receives compensation at a rate not less than one and one-half times the basic rate of pay for all hours worked in excess of forty hours in such workweek.

2. Violation; Liability for Unpaid Wages; Liquidated Damages.

In the event of any violation of the clause set forth in paragraph (1) of this clause, the contractor and any subcontractor responsible therefor shall be liable for the unpaid wages. In addition, such contractor and subcontractor shall be liable to the United States (in the case of work done under contract for the District of Columbia or a territory, to such District or to such territory), for liquidated damages. Such liquidated damages shall be computed with respect to each individual laborer or mechanic, including watchmen and guards, employed in violation of the clause set forth in paragraph (1) of this clause, in the sum of \$10 for each calendar day on which such individual was required or permitted to work in excess of the standard workweek of forty hours without payment of the overtime wages required by the clause set forth in paragraph (1) of this clause.

3. Withholding for Unpaid Wages and Liquidated Damages.

The Federal Aviation Administration (FAA) or the Owner shall upon its own action or upon written request of an authorized representative of the Department of Labor withhold or cause to be withheld, from any moneys payable on account of work performed by the contractor or subcontractor under any such contract or any other Federal contract with the same prime contractor, or any other Federally-assisted contract subject to the Contract Work Hours and Safety Standards Act, which is held by the same prime contractor, such sums as may be determined to be necessary to satisfy any liabilities of such contractor or subcontractor for unpaid wages and liquidated damages as provided in the clause set forth in paragraph 2 of this clause.

#### 4. Subcontractors.

The contractor or subcontractor shall insert in any subcontracts the clauses set forth in paragraphs (1) through (4) and also a clause requiring the subcontractor to include these clauses in any lower tier subcontracts. The prime contractor shall be responsible for compliance by any subcontractor or lower tier subcontractor with the clauses set forth in paragraphs (1) through (4) of this clause.

#### **B. LOBBYING AND INFLUENCING FEDERAL EMPLOYEES**

The contractor certifies by signing and submitting this bid or proposal, to the best of his or her knowledge and belief, that:

- (1) No Federal appropriated funds have been paid or will be paid, by or on behalf of the contractor, to any person for influencing or attempting to influence an officer or employee of an agency, a Member of Congress, an officer or employee of Congress, or an employee of a Member of Congress in connection with the awarding of any Federal contract, the making of any Federal grant, the making of any Federal loan, the entering into of any cooperative agreement, and the extension, continuation, renewal, amendment, or modification of any Federal contract, grant, loan, or cooperative agreement.
- (2) If any funds other than Federal appropriated funds have been paid or will be paid to any person for influencing or attempting to influence an officer or employee of any agency, a Member of Congress, an officer or employee of Congress, or an employee of a Member of Congress in connection with this Federal contract, grant, loan, or cooperative agreement, the undersigned shall complete and submit Standard Form-LLL, "Disclosure Form to Report Lobbying," in accordance with its instructions.
- (3) The contractor shall require that the language of this certification be included in the award documents for all sub-awards at all tiers (including subcontracts, sub-grants, and contracts under grants, loans, and cooperative agreements) and that all sub-recipients shall certify and disclose accordingly.

This certification is a material representation of fact upon which reliance was placed when this transaction was made or entered into. Submission of this certification is a prerequisite for making or entering into this transaction imposed by section 1352, title 31, U.S. Code. Any person who fails to file the required certification shall be subject to a civil penalty of not less than \$10,000 and not more than \$100,000 for each such failure.



**VI. PROVISIONS APPLICABLE TO LEASES  
\$150,000 AND GREATER**

**A. BREACH OF CONTRACT TERMS**

Any violation or breach of terms of this contract on the part of the contractor or its subcontractors may result in the suspension or termination of this contract or such other action that may be necessary to enforce the rights of the parties of this agreement.

Sponsor will provide the contractor with written notice that describes the nature of the breach and corrective actions the contractor must undertake in order to avoid termination of the contract. Sponsor reserves the right to withhold payments to Contractor until such time the Contractor corrects the breach or the Sponsor elects to terminate the contract. The Sponsor's notice will identify a specific date by which the contractor must correct the breach. Sponsor may proceed with termination of the contract if the contractor fails to correct the breach by deadline indicated in the Sponsor's notice.

The duties and obligations imposed by the Contract Documents and the rights and remedies available thereunder are in addition to, and not a limitation of, any duties, obligations, rights and remedies otherwise imposed or available by law.

**B. CLEAN AIR AND WATER POLLUTION CONTROL**

Contractor agrees to comply with all applicable standards, orders, and regulations issued pursuant to the Clean Air Act (42 U.S.C. § 740-7671q) and the Federal Water Pollution Control Act as amended (33 U.S.C. § 1251-1387). The Contractor agrees to report any violation to the Sponsor immediately upon discovery. The Sponsor assumes responsibility for notifying the Environmental Protection Agency (EPA) and the Federal Aviation Administration.

Contractor must include this requirement in all subcontracts that exceeds \$150,000.

///

///

**Attachment A: CERTIFICATE OF BUY AMERICAN COMPLIANCE FOR  
TOTAL FACILITY**

(Buildings such as Terminal, SRE, ARFF, etc.)

As a matter of bid responsiveness, the bidder or offeror must complete, sign, date, and submit this certification statement with their proposal. The bidder or offeror must indicate how they intend to comply with 49 USC § 50101 by selecting one of the following certification statements. These statements are mutually exclusive. Bidder must select one or the other (i.e. not both) by inserting a checkmark (✓) or the letter "X".

- Bidder or offeror hereby certifies that it will comply with 49 USC. 50101 by:
- a) Only installing steel and manufactured products produced in the United States; or
  - b) Installing manufactured products for which the FAA has issued a waiver as indicated by inclusion on the current FAA Nationwide Buy American Waivers Issued listing; or
  - c) Installing products listed as an Excepted Article, Material or Supply in Federal Acquisition Regulation Subpart 25.108.

By selecting this certification statement, the bidder or offeror agrees:

1. To provide to the Owner evidence that documents the source and origin of the steel and manufactured product.
2. To faithfully comply with providing US domestic products
3. To refrain from seeking a waiver request after establishment of the contract, unless extenuating circumstances emerge that the FAA determines justified.

- The bidder or offeror hereby certifies it cannot comply with the 100% Buy American Preferences of 49 USC § 50101(a) but may qualify for either a Type 3 or Type 4 waiver under 49 USC § 50101(b). By selecting this certification statement, the apparent bidder or offeror with the apparent low bid agrees:

1. To the submit to the Owner within 15 calendar days of the bid opening, a formal waiver request and required documentation that support the type of waiver being requested.
2. That failure to submit the required documentation within the specified timeframe is cause for a non-responsive determination may results in rejection of the proposal.
3. To faithfully comply with providing US domestic products at or above the approved US domestic content percentage as approved by the FAA.
4. To furnish US domestic product for any waiver request that the FAA rejects.
5. To refrain from seeking a waiver request after establishment of the contract, unless extenuating circumstances emerge that the FAA determines justified.

**Required Documentation**

**Type 3 Waiver** - The cost of components and subcomponents produced in the United States is more that 60% of the cost of all components and subcomponents of the “facility”. The required documentation for a type 3 waiver is:

- a) Listing of all manufactured products that are not comprised of 100% US domestic content (Excludes products listed on the FAA Nationwide Buy American Waivers Issued listing and products excluded by Federal Acquisition Regulation Subpart 25.108; products of unknown origin must be considered as non-domestic products in their entirety)
- b) Cost of non-domestic components and subcomponents, excluding labor costs associated with final assembly and installation at project location.
- c) Percentage of non-domestic component and subcomponent cost as compared to total “facility” component and subcomponent costs, excluding labor costs associated with final assembly and installation at project location.

**Type 4 Waiver** – Total cost of project using US domestic source product exceeds the total project cost using non-domestic product by 25%. The required documentation for a type 4 of waiver is:

- a) Detailed cost information for total project using US domestic product
- b) Detailed cost information for total project using non-domestic product

**False Statements:** Per 49 USC § 47126, this certification concerns a matter within the jurisdiction of the Federal Aviation Administration and the making of a false, fictitious or fraudulent certification may render the maker subject to prosecution under Title 18, United States Code.

\_\_\_\_\_  
Date

\_\_\_\_\_  
Signature

\_\_\_\_\_  
Company Name

\_\_\_\_\_  
Title

**Attachment B: CERTIFICATE OF BUY AMERICAN COMPLIANCE FOR  
MANUFACTURED PRODUCTS**

(Non-building construction projects, equipment acquisition projects)

As a matter of bid responsiveness, the bidder or offeror must complete, sign, date, and submit this certification statement with their proposal. The bidder or offeror must indicate how they intend to comply with 49 USC § 50101 by selecting one on the following certification statements. These statements are mutually exclusive. Bidder must select one or the other (not both) by inserting a checkmark (✓) or the letter "X".

- Bidder or offeror hereby certifies that it will comply with 49 USC § 50101 by:
- a) Only installing steel and manufactured products produced in the United States, or;
  - b) Installing manufactured products for which the FAA has issued a waiver as indicated by inclusion on the current FAA Nationwide Buy American Waivers Issued listing, or;
  - c) Installing products listed as an Excepted Article, Material or Supply in Federal Acquisition Regulation Subpart 25.108.

By selecting this certification statement, the bidder or offeror agrees:

1. To provide to the Owner evidence that documents the source and origin of the steel and manufactured product.
  2. To faithfully comply with providing US domestic product
  3. To furnish US domestic product for any waiver request that the FAA rejects
  4. To refrain from seeking a waiver request after establishment of the contract, unless extenuating circumstances emerge that the FAA determines justified.
- The bidder or offeror hereby certifies it cannot comply with the 100% Buy American Preferences of 49 USC § 50101(a) but may qualify for either a Type 3 or Type 4 waiver under 49 USC § 50101(b). By selecting this certification statement, the apparent bidder or offeror with the apparent low bid agrees:

To the submit to the Owner within 15 calendar days of the bid opening, a formal waiver request and required documentation that support the type of waiver being requested.

1. That failure to submit the required documentation within the specified timeframe is cause for a non-responsive determination may result in rejection of the proposal.
2. To faithfully comply with providing US domestic products at or above the approved US domestic content percentage as approved by the FAA.
3. To refrain from seeking a waiver request after establishment of the contract, unless extenuating circumstances emerge that the FAA determines justified.

**Required Documentation**

**Type 3 Waiver** - The cost of the item components and subcomponents produced in the United States is more that 60% of the cost of all components and subcomponents of the "item". The required documentation for a type 3 waiver is:

- a) Listing of all product components and subcomponents that are not comprised of 100% US domestic content (Excludes products listed on the FAA Nationwide Buy American Waivers Issued listing and products excluded by Federal Acquisition Regulation Subpart 25.108; products of unknown origin must be considered as non-domestic products in their entirety)
- b) Cost of non-domestic components and subcomponents, excluding labor costs associated with final assembly at place of manufacture.
- c) Percentage of non-domestic component and subcomponent cost as compared to total "item" component and subcomponent costs, excluding labor costs associated with final assembly at place of manufacture.

**Type 4 Waiver** – Total cost of project using US domestic source product exceeds the total project cost using non-domestic product by 25%. The required documentation for a type 4 of waiver is:

- a) Detailed cost information for total project using US domestic product
- b) Detailed cost information for total project using non-domestic product

**False Statements:** Per 49 USC § 47126, this certification concerns a matter within the jurisdiction of the Federal Aviation Administration and the making of a false, fictitious or fraudulent certification may render the maker subject to prosecution under Title 18, United States Code.

---

Date

---

Signature

---

Company Name

---

Title