

RESOLUTION NO. _____

A RESOLUTION OF THE COUNCIL OF THE CITY OF FRESNO DETERMINING THAT PUBLIC INTEREST AND NECESSITY REQUIRE ACQUISITION OF PERMANENT EASEMENTS AND RIGHTS OF WAY AND TEMPORARY CONSTRUCTION EASEMENTS FOR PUBLIC PURPOSES OVER, UNDER, THROUGH AND ACROSS REAL PROPERTIES FOR THE CONSTRUCTION OF A RAW WATER PIPELINE AND RELATED PURPOSES AND AUTHORIZING EMINENT DOMAIN PROCEEDINGS FOR PUBLIC USE AND PURPOSE

WHEREAS, the City of Fresno proposes to develop a roughly five-mile long, 60-inch diameter raw water pipeline and conveyance system that will bring the City's existing Central Valley Project (CVP) contract supply raw water directly from the Friant-Kern Canal to the Northeast Surface Water Treatment Facility (NESWTF) for treatment and then delivery to the City's water customers (the "Project"); and

WHEREAS, the proposed Project is necessary to provide a more reliable, uninterrupted service to the NESWTF; reduce severe groundwater overdraft; supply an alternative connection to the Friant-Kern Canal to deliver the City's CVP water allocation to the NESWTF so as to fully utilize the water treatment capacity at that facility; enable the new pipeline to be the primary conveyance for the raw water source and the Enterprise Canal to become the backup conveyance; provide improved raw water quality by protecting the conveyance system from both inadvertent contamination and intentional malicious acts; reduce chemical treatment costs by utilizing improved quality supply water; provide onsite hydropower generation for the NESWTF thereby reducing purchased power costs; and reduce previous power consumption and costs by

Date Adopted:
Date Approved:
Effective Date:
City Attorney Approval:

TNP

Resolution No.

eliminating the use of Enterprise Canal raw water pumps when using the primary supply source as well as reducing the need for well pumping throughout the City; and

WHEREAS, the Project was assessed in EA-11-13 under the California Environmental Quality Act (CEQA) and a Mitigated Negative Declaration and mitigation monitoring and reporting plan was adopted by the council on June 14, 2012; and

WHEREAS, the Project is being assessed under the National Environmental Policy Act (NEPA) by the US Bureau of Reclamation and a Finding of No Significant Impact (FONSI) is anticipated pursuant to the NEPA regulations and procedures; and

WHEREAS, the easements are located in the unincorporated area of Fresno County and by action of the County Board of Supervisors on March 8, 2011, a copy of which is attached as Exhibit 6, the County has granted the City permission to acquire easements within its jurisdiction by condemnation; and

WHEREAS, the Project is planned or located in the manner that will be the most compatible with the greatest public good and the least private injury; it is necessary to acquire easements and use temporary construction easements (TCE) from the subject properties for installation and construction of the pipeline and to provide for ongoing maintenance and operation of the pipeline; the design of the project has been reviewed and some changes have been made to minimize the effects on the individual parcels, but the Project cannot be constructed without acquiring the minimal amount of permanent and temporary easements being sought; and

WHEREAS, it appears necessary and desirable for the City to acquire permanent easements and to obtain temporary construction easements over, under, through and across the real properties (hereinafter called the "Subject Properties") for construction of the Project and related purposes; and

WHEREAS, the general location of the Subject Properties and the current ownership of the Subject Properties is shown on the table labelled Exhibit 1.

WHEREAS, the permanent easements to be acquired and the temporary construction easements and their general location and extent are described and illustrated in the corresponding attached Exhibits 2 through 4; and

WHEREAS, the general location of the Project, and its relation to the Subject Properties and the permanent easements and temporary construction easements to be acquired, is illustrated in the Attached Exhibit 5; and

WHEREAS, the City has the power and authority to acquire easements and rights of way by eminent domain in accordance with the California Constitution, California Eminent Domain Law, Section 200 of the Charter of the City of Fresno, and pursuant to Government Code Sections 37350.5; and

WHEREAS, in accordance with Section 7267.2 of the Government Code and 25 C.C.R. 6182(d), an offer to purchase has been made to the owner or owners of record of the Subject Properties; and

WHEREAS, in accordance with Section 1245.235 of the Code of Civil Procedure, notice and reasonable opportunity to appear and be heard on this matter has been given to the persons whose property is to be acquired by eminent domain and whose names and addresses appear on the last equalized county assessment roll; and

WHEREAS, at such time and place, or as soon thereafter as the matter could be heard, the Council received, heard and considered information pertinent to the matters required by Section 1245.230 of the Code of Civil Procedure to be determined herein; and

WHEREAS, the permanent easements and rights of way will be appropriated to a public use and in accordance with Code of Civil Procedure section 1240.510 the proposed use will not unreasonably interfere with or impair the continuance of any public use that may now exist or may reasonably be expected to exist in the future.

NOW, THEREFORE, BE IT RESOLVED the Council of the City of Fresno finds, declares, determines, and orders as follows:

1. The public interest and necessity require the proposed Project.
2. The Project is planned or located in the manner that will be most compatible with the greatest public good and the least private injury.
3. The permanent easements and the temporary construction easements are necessary for the Project.
4. The offer to purchase required by Section 7267.2 of the Government Code and 25 C.C.R. 6182(d) has been made to the owner(s) of record.
5. The permanent easements and the temporary construction easements situated in the County of Fresno, State of California, are more particularly described and illustrated in Exhibits 2 through 5.
6. The City Attorney is authorized and directed to institute and conduct to conclusion, in the name of the City, proceedings in eminent domain in accordance with the provisions of the Constitution of the State of California and the California Eminent Domain Law, to acquire easements in the name of the City for public purposes.
7. Project ID WC00038, Fund 40184, has been established to disburse the necessary funds for the acquisition of the easements and to pay for litigation expenses, including staff time.

8. The Controller of the City is authorized to disburse out of the above trust account, as approved by the City Attorney, such amounts as may be required including costs, witness fees, and attorneys' fees, to acquire possession or title to the permanent and temporary easements.

* * * * *

STATE OF CALIFORNIA)
COUNTY OF FRESNO) ss.
CITY OF FRESNO)

I, YVONNE SPENCE, City Clerk of the City of Fresno, certify that the foregoing resolution was adopted by the Council of the City of Fresno, at a regular meeting held on the _____ day of _____, 2015.

AYES :
NOES :
ABSENT :
ABSTAIN :

Mayor Approval: _____, 2015
Mayor Approval/No Return: _____, 2015
Mayor Veto: _____, 2015
Council Override Vote: _____, 2015

YVONNE SPENCE, CMC
City Clerk

BY: _____
Deputy

APPROVED AS TO FORM:
CITY ATTORNEY'S OFFICE

BY: _____
Tracy N. Parvanian, Date
Deputy City Attorney

Attachments: Exhibits 1 through 6

TNP:pn,prn [66628/reso] Reso 01/07/15

EXHIBIT LIST

- Exhibit 1 - Table of owner, parcel and easement details
- Exhibit 2 - Lichti
 - 2-A legal description/pipeline easement/581-030-02s
 - 2-B diagram/pipeline easement/581-030-02s
 - 2-C legal description/TCE/581-030-02s
 - 2-D diagram/TCE/581-030-02s
- Exhibit 3 - Lesher
 - 3-A legal description/pipeline easement/580-040-07
 - 3-B diagram/pipeline easement/580-040-07
 - 3-C legal description/TCE/580-040-07
 - 3-D diagram/TCE/580-040-07
 - 3-E legal description/pipeline easement/580-040-08
 - 3-F diagram/pipeline easement/580-040-08
 - 3-G legal description/TCE/580-040-08
 - 3-H diagram/TCE/580-040-08
- Exhibit 4 - Herold
 - 4-A legal description/TCE/581-020-05s
 - 4-B diagram/TCE/581-020-05s
- Exhibit 5 - Map of entire project
- Exhibit 6 - County authorization

Exhibit 1 - Table of owner, parcel and easement details

Project Parcel Number	APN of Subject Property	Location	Owner(s)
1 (Pipeline and TCE)	581-030-02s	12389 N. Armstrong Ave, Clovis, CA 93619	Rodric H. Lichti and Kimberly K. Lichti
2 (Pipeline and TCE)	580-040-07 580-040-08	3310 E. Copper Avenue Clovis, CA 93619	Earleen Leshner; the Estate of Velda D. Leshner
3 (TCE)	581-020-05s	West side of N. Armstrong, North of Copper Ave., Clovis, CA 93619	Lilli Herold and Linda E. Cheney, Trustees of the Lilli Herold Living Trust, dated December 18, 1997

Exhibit 2 – Lichti

- 2-A legal description/pipeline easement/581-030-02s
- 2-B diagram/pipeline easement/581-030-02s
- 2-C legal description/TCE/581-030-02s
- 2-D diagram/TCE/581-030-02s

EXHIBIT "A"
Page 1 of 1

APN: 581-030-02S (Portion)
Pipeline Easement

A portion of Lot 55 of Tract No. 2137, Appaloosa Acres, according to the map thereof recorded in Volume 23 of Plats at Pages 66 and 67, Fresno County Records, situated in the southeast quarter of Section 4, Township 12 South, Range 21 East, Mount Diablo Base and Meridian, situated in the County of Fresno, State of California, according to the Official United States Government Township Plat thereof, being more particularly described as follows:

Beginning at the northwest corner of said Lot 55; thence

- 1) South 89° 04' 02" East, along the north line of said Lot 55, a distance of 268.37 feet; thence leaving said north line
- 2) South 72° 28' 48" West, a distance of 142.17 feet to a point 45.00 feet southerly of said north line; thence
- 3) North 89° 04' 02" West, parallel with and 45.00 feet southerly of said north line, a distance of 135.01 feet to the west line of said Lot 55; thence
- 4) North 02° 50' 20" East, along said west line, a distance of 45.02 feet to the Point of Beginning.

Containing an area of 9,076 square feet, more or less.

END OF DESCRIPTION

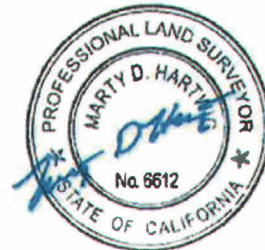

Date
Signed 8/3/2011

2010-069
15-A-8771
WJ No. 5354

REF & REV: 2010-069 PLAT NO. 0002 WJ 5354	CITY OF FRESNO DEPARTMENT OF PUBLIC WORKS PORTION of S.E. 1/4 SEC. 4, T.12 S., R.21 E., M.D.B. & M. To be Deeded for PIPELINE PURPOSES	SHEET NO. 1 OF 1 SHEETS 15-A-8771
PROJ. ID: W000038 FUND NO. 40118 ORG. NO. 411501	DR. BY: BSG CH. BY: 07/21/11 DATE: 07/21/11 SCALE: 1" = 100'	

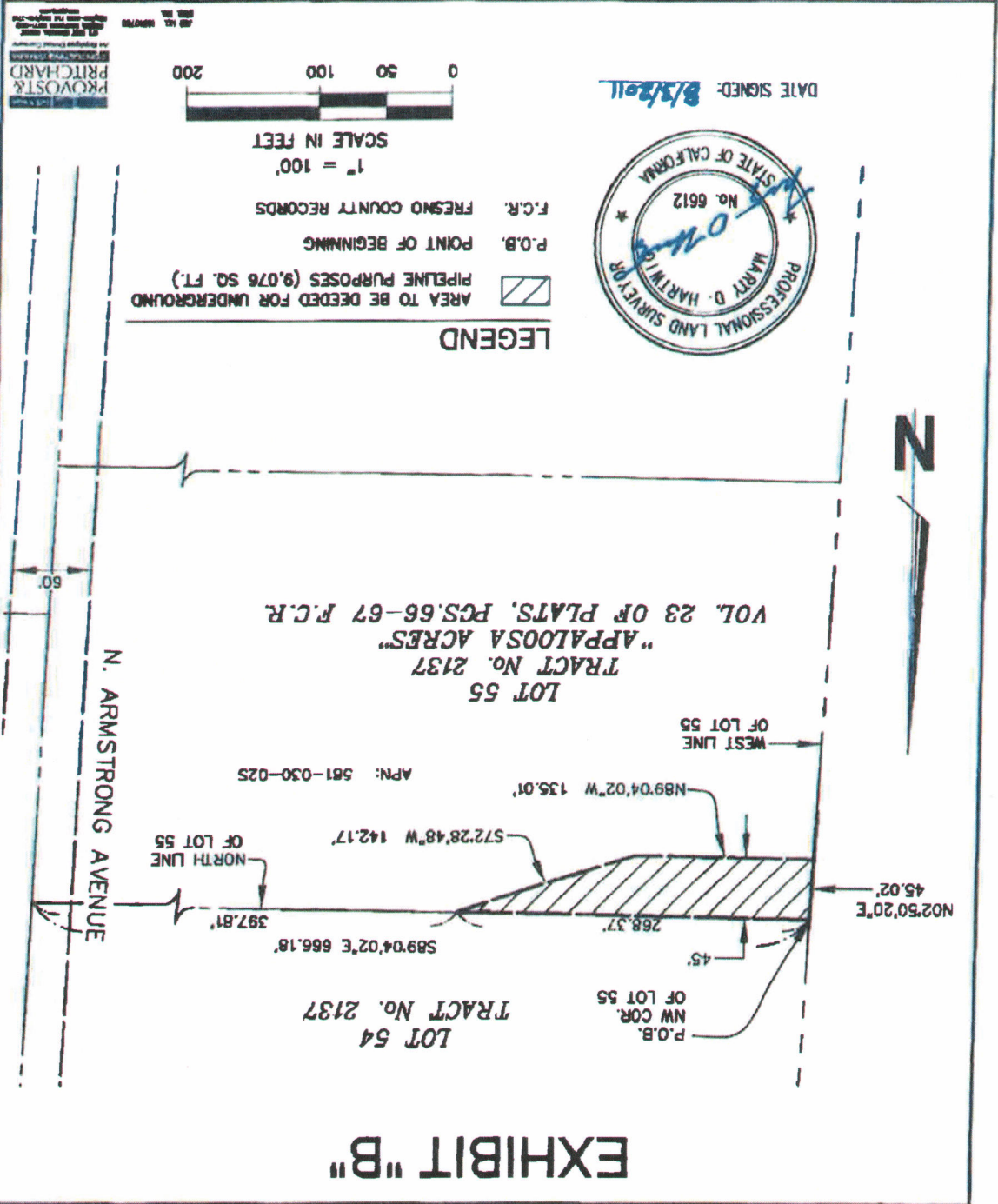

EXHIBIT "C"
Page 1 of 1

APN: 581-030-02S (Portion)
Construction Easement

A portion of Lot 55 of Tract No. 2137, Appaloosa Acres, according to the map thereof recorded in Volume 23 of Plats at Pages 66 and 67, Fresno County Records, situated in the southeast quarter of Section 4, Township 12 South, Range 21 East, Mount Diablo Base and Meridian, situated in the County of Fresno, State of California, according to the Official United States Government Township Plat thereof, being more particularly described as follows:

Commencing at the northwest corner of said Lot 55; thence South 89° 04' 02" East, along the north line of said Lot 55, a distance of 268.37 feet to the True Point of Beginning; thence leaving said north line

- 1) South 72° 28' 48" West, a distance of 142.17 feet, to a point 45.00 feet southerly of said north line; thence
- 2) North 89° 04' 02" West, parallel with and 45.00 feet south of said north line, a distance of 135.01 feet to the west line of said Lot 55; thence
- 3) South 02° 50' 20" West, along said west line, a distance of 35.02 feet; thence
- 4) South 89° 04' 02" East, parallel with and 80.00 feet southerly of said north line, a distance of 110.26 feet; thence leaving said parallel line
- 5) North 72° 28' 48" East, a distance of 252.75 feet to a point on said north line, said point bears South 89° 04' 02" East, a distance of 347.35 feet, from said northwest corner; thence
- 6) North 89° 04' 02" West, along said north line, a distance of 78.98 feet to the True Point of Beginning.

Containing an area of 9,229 square feet, more or less.

END OF DESCRIPTION



Date 2/7/19
Signed

2010-069T
15-A-8771T
WJ No. 5354

EXHIBIT "D"

LOT 54
TRACT No. 2137

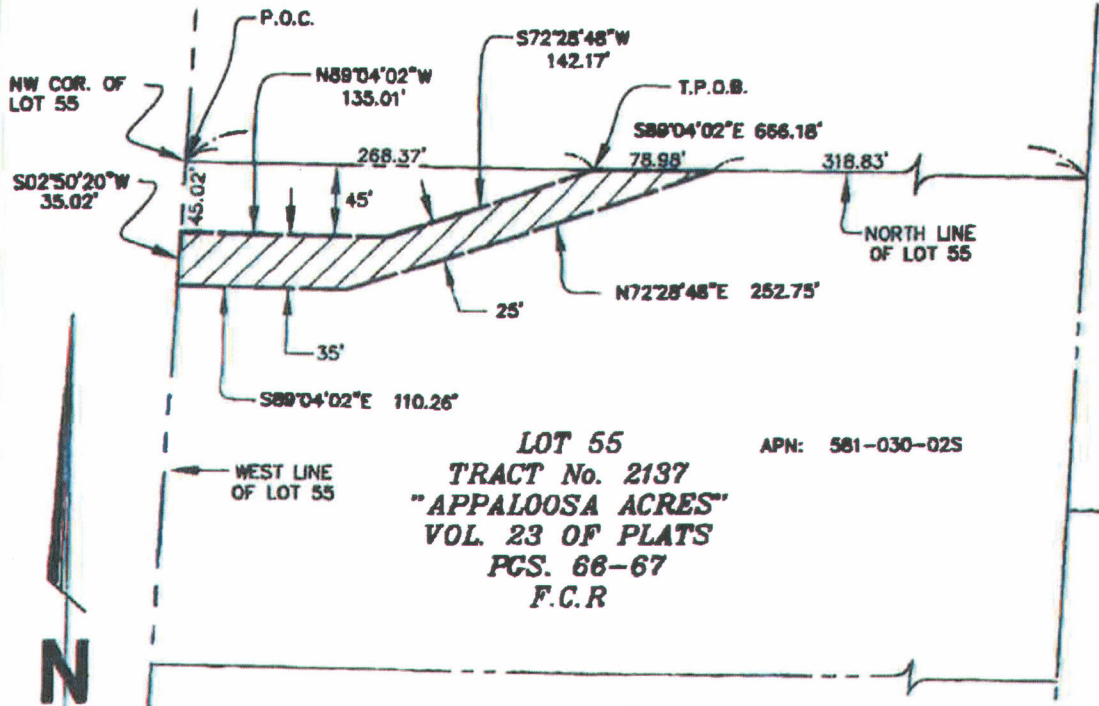

LOT 55
TRACT No. 2137
"APPALOOSA ACRES"
VOL. 23 OF PLATS
PGS. 66-67
F.C.R

APN: 581-030-025

LEGEND

-  AREA FOR TEMPORARY CONSTRUCTION PURPOSES (9,228 SQ. FT.)
- F.C.R. FRESNO COUNTY RECORDS
- P.O.C. POINT OF COMMENCEMENT
- T.P.O.B. TRUE POINT OF BEGINNING



DATE SIGNED: 2/7/14

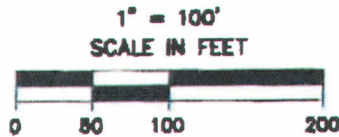

REF. & REV. 2010-0897	CITY OF FRESNO DEPARTMENT OF PUBLIC WORKS	PROJ. ID. <u>W000038</u>	SHEET NO. <u>1</u> OF <u>1</u> SHEETS
		FUND NO. <u>40718</u>	
PLAT NO. 0002 WJ 5354	PORTION of S.E. 1/4, SEC. 4, T.12 S., R.21 E., M.D.B. & M. for TEMPORARY CONSTRUCTION PURPOSES	OR. BY <u>BMC</u>	15-A-8771T
		CH. BY <u>MDH</u>	
		DATE <u>07/21/11</u>	
		SCALE <u>1" = 100'</u>	

Exhibit 3 – Lesher

- 3-A legal description/pipeline easement/580-040-07
- 3-B diagram/pipeline easement/580-040-07
- 3-C legal description/TCE/580-040-07
- 3-D diagram/TCE/580-040-07
- 3-E legal description/pipeline easement/580-040-08
- 3-F diagram/pipeline easement/580-040-08
- 3-G legal description/TCE/580-040-08
- 3-H diagram/TCE/580-040-08

EXHIBIT "A"
Page 1 of 2

APN: 580-040-07 (Portion)
Pipeline Easement

All of that portion of the southwest quarter of Section 7, Township 12 South, Range 21 East, Mount Diablo Base and Meridian, situated in the County of Fresno, State of California, according to the Official United States Government Township Plat thereof, described as follows:

Beginning at the west quarter corner of said Section 7; thence

- 1) South 87° 53' 33" East, along the north line of the southwest quarter of said Section 7, a distance of 2838.86 feet to the northeast corner of said southwest quarter; thence**
- 2) South 00° 09' 20" West, along the east line of said southwest quarter, a distance of 65.04 feet to a line parallel with and 65.00 feet south of, measured at right angles, the north line of said southwest quarter; thence**
- 3) North 87° 53' 33" West, along said parallel line, a distance of 2773.74 feet to a line parallel with and 65.00 feet east of, measured at right angles, the west line of said southwest quarter; thence**
- 4) South 00° 05' 00" West, along the last said parallel line, a distance of 885.44 feet to the point of beginning of a non-tangent curve, concave westerly, with a radius of 1255.00 feet, a radial to said point bears North 81° 49' 46" East; thence**
- 5) southerly, along the arc of said curve, through a central angle of 8° 15' 14", an arc distance of 180.79 feet to a line parallel with and 78.00 feet east of, measured at right angles, the west line of said southwest quarter; thence**
- 6) South 00° 05' 00" West, along said parallel line, a distance of 426.39 feet to the beginning of a tangent curve, concave westerly, with a radius of 515.00 feet; thence**
- 7) southerly, along the arc of said curve, through a central angle of 12° 50' 19", an arc distance of 115.40 feet to the beginning of a reverse curve, concave easterly, with a radius of 485.00 feet; thence**
- 8) southerly, along the arc of said curve, through a central angle of 12° 50' 19", an arc distance of 108.68 feet to a line parallel with and 53.00 feet east of, measured at right angles, the west line of said southwest quarter; thence**
- 9) South 00° 05' 00" West, along said parallel line, a distance of 842.94 feet to the northerly right-of-way line of that portion of Copper Avenue previously acquired by the County of Fresno by that Grant Deed recorded September 29, 1981 in Book 7793 at Page 275, Official Records of Fresno County; thence**

2010-085
15-A-8784
W.J. No. 5354

EXHIBIT "A"
Page 2 of 2

- 10) North 88° 14' 58" West, along said northerly right-of-way line, a distance of 3.01 feet; thence
- 11) North 44° 04' 59" West, continuing along said northerly line, a distance of 28.69 feet to a line parallel with and 30.00 feet east of, measured at right angles, the west line of said southwest quarter; thence
- 12) North 00° 05' 00" East, along said parallel line, a distance of 1489.93 feet to the beginning of a tangent curve, concave westerly, with a radius of 1030.00 feet; thence
- 13) northerly, along the arc of said curve, through a central angle of 6° 25' 00", an arc distance of 115.35 feet; thence
- 14) North 06° 20' 00" West, a distance of 210.70 feet to the west line of said southwest quarter; thence
- 15) North 00° 05' 00" East, along said west line, a distance of 789.40 feet to the Point of Beginning.

Containing an area of 6.81 acres, more or less.

END OF DESCRIPTION



Date
Signed 2/7/19

2010-085
15-A-8784
W.J. No. 5354

EXHIBIT "B"

(PAGE 1 OF 2)



1" = 400'
SCALE IN FEET

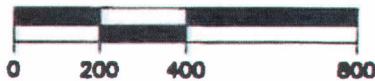

N.W. 1/4
SEC. 7
12/21

C. 1/4 COR.
SEC. 7, 12/21

S00°09'20"W
65.04'

EAST LINE OF THE SW
1/4 OF SECTION 7, 12/21

NORTH LINE OF THE SW
1/4 OF SECTION 7, 12/21

APN: 580-040-07

S.W. 1/4 SEC. 7 12/21

P.O.B.
W. 1/4 COR.
SEC. 7, 12/21

MATCH LINE
SEE SHEET 2

WEST LINE OF THE SW
1/4 OF SECTION 7, 12/21

APN:
579-074-47

WILLOW AVENUE



DATE SIGNED: 2/7/14

LEGEND



AREA TO BE DEEDED FOR UNDERGROUND
PIPELINE PURPOSES (6.81 ACRES)

P.O.B. POINT OF BEGINNING

PROVOST & PRITCHARD
An Employee Owned Company

JOB NO. 1380708

REF. & REV. 2010-085 PLAT NO. 0002 WJ 5354	CITY OF FRESNO DEPARTMENT OF PUBLIC WORKS	PROJ. ID. <u>WC00038</u> FUND NO. <u>40118</u> ORG. NO. <u>411501</u>	SHEET NO. <u>1</u> OF <u>2</u> SHEETS
	PORTION of S.W. 1/4, SEC. 7, T.12 S., R.21 E., M.D.B. & M. To be Deeded for PIPELINE PURPOSES	DR. BY <u>JDL</u> CH. BY <u>MDH</u> DATE <u>02/06/14</u> SCALE <u>1" = 400'</u>	15-A-8784

EXHIBIT "B"

(PAGE 2 OF 2)

LEGEND

 AREA TO BE DEEDED FOR UNDERGROUND PIPELINE PURPOSES (6.81 ACRES)

P.O.B. POINT OF BEGINNING

• PREVIOUSLY GRANTED IN FEE SIMPLE TO THE COUNTY OF FRESNO BY THAT DEED RECORDED 9/29/1981 IN BOOK 7793 AT PAGE 275, O.R.F.C.

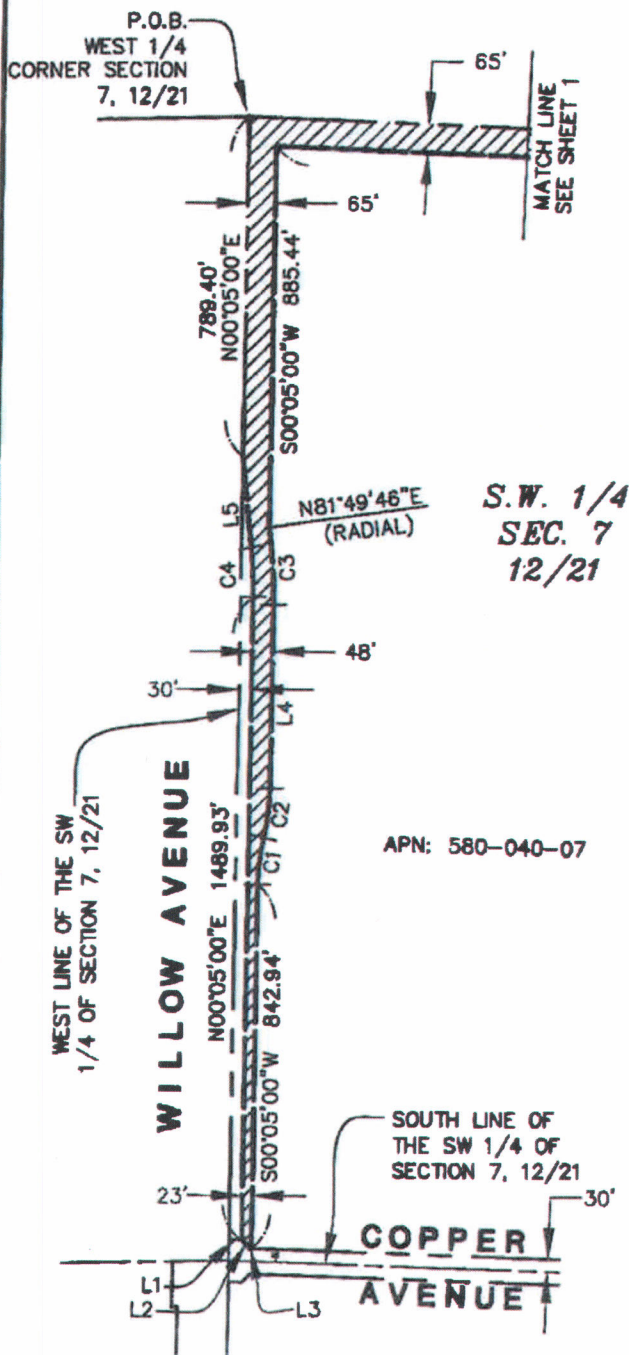

DATE SIGNED: 2/7/14

1" = 400'
SCALE IN FEET

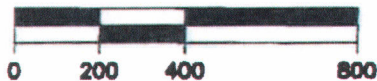

CURVE TABLE			
CURVE	RADIUS	LENGTH	DELTA
C1	485.00	108.68	12°50'19"
C2	515.00	115.40	12°50'19"
C3	1255.00	180.79	8°15'14"
C4	1030.00	115.35	6°25'00"

LINE TABLE		
LINE	BEARING	LENGTH
L1	N88°14'58"W	30.00
L2	N44°04'59"W	28.69
L3	N88°14'58"W	3.01
L4	S00°05'00"W	426.39
L5	N06°20'00"W	210.70

PROVOST & PRITCHARD

An Employee Owned Company
200 WEST BROADWAY, SUITE 200
FRESNO, CALIFORNIA 93701-2000
TEL: 209-442-2200 FAX: 209-442-2201

JOB NO. 18810782

REF. & REV.
2010-085
PLAT NO. 0002
WJ 5354

CITY OF FRESNO
DEPARTMENT OF PUBLIC WORKS

PORTION of
S.W. 1/4, SEC. 7, T.12 S., R.21 E., M.D.B. & M.
To be Deeded for PIPELINE PURPOSES

PROJ. ID. WC00038
FUND NO. 40118
ORG. NO. 411501

DR. BY JDL
CH. BY MDH
DATE 02/06/14
SCALE 1" = 400'

SHEET NO. 2
OF 2 SHEETS
15-A-8784

EXHIBIT "C"

Page 1 of 2

APN: 580-040-07 (Portion)
Construction Easement

All of that portion of the southwest quarter of Section 7, Township 12 South, Range 21 East, Mount Diablo Base and Meridian, situated in the County of Fresno, State of California, according to the Official United States Government Township Plat thereof, described as follows:

Commencing at the west quarter corner of said Section 7; thence South $00^{\circ} 05' 00''$ West, along the west line of the southwest quarter of said Section 7, a distance of 65.04 feet to a line parallel with and 65.00 feet south of, measured at right angles, the north line of said southwest quarter; thence South $87^{\circ} 53' 33''$ East, along said parallel line, a distance of 65.04 feet to the True Point of Beginning of this description; thence

- 1) South $87^{\circ} 53' 33''$ East, continuing along said parallel line, a distance of 2773.74 feet to the east line of said southwest quarter; thence
- 2) South $00^{\circ} 09' 20''$ West, along the east line of said southwest quarter, a distance of 135.08 feet to a line parallel with and 200.00 feet south of, measured at right angles, the north line of said southwest quarter; thence
- 3) North $87^{\circ} 53' 33''$ West, along said parallel line, a distance of 1325.79 feet; thence
- 4) North $02^{\circ} 06' 27''$ East, a distance of 110.00 feet to a line parallel with and 90.00 feet south of, measured at right angles, the north line of said southwest quarter; thence
- 5) North $87^{\circ} 53' 33''$ West, along the last said parallel line, a distance of 1426.65 feet to a line parallel with and 90.00 feet east of, measured at right angles, the west line of said southwest quarter; thence
- 6) South $00^{\circ} 05' 00''$ West, along the last said parallel line, a distance of 781.72 feet to the point of beginning of a non-tangent curve, concave westerly, with a radius of 1293.00 feet, a radial to said point bears North $78^{\circ} 34' 26''$ East; thence
- 7) southerly, along the arc of said curve, through a central angle of $11^{\circ} 30' 34''$, an arc distance of 259.74 feet to a line parallel with and 116.00 feet east of, measured at right angles, the west line of said southwest quarter; thence
- 8) South $00^{\circ} 05' 00''$ West, along said parallel line, a distance of 426.39 feet to the beginning of a tangent curve, concave westerly, with a radius of 553.00 feet; thence
- 9) southerly, along the arc of said curve, through a central angle of $12^{\circ} 50' 19''$, an arc distance of 123.91 feet to the beginning of a reverse curve, concave easterly, with a radius of 447.00 feet; thence

2010-085T
15-A-8784T
W.J. No. 5354

EXHIBIT "C"

Page 2 of 2

- 10) southerly, along the arc of said curve, through a central angle of $12^{\circ} 50' 19''$, an arc distance of 100.16 feet to a line parallel with and 91.00 feet east of, measured at right angles, the west line of said southwest quarter; thence
- 11) South $00^{\circ} 05' 00''$ West, along said parallel line, a distance of 844.04 feet to the northerly right-of-way line of that portion of Copper Avenue previously acquired by the County of Fresno by that Grant Deed recorded September 29, 1981 in Book 7793 at Page 275, Official Records of Fresno County; thence
- 12) North $88^{\circ} 14' 58''$ West, along said northerly right-of-way line, a distance of 38.02 feet to a line parallel with and 53.00 feet east of, measured at right angles, the west line of said southwest quarter; thence
- 13) North $00^{\circ} 05' 00''$ East, along said parallel line, a distance of 842.94 feet to the beginning of a tangent curve, concave easterly, with a radius of 485.00 feet; thence
- 14) northerly, along the arc of said curve, through a central angle of $12^{\circ} 50' 19''$, an arc distance of 108.68 feet to the beginning of a reverse curve, concave westerly, with a radius of 515.00 feet; thence
- 15) northerly, along the arc of said curve, through a central angle of $12^{\circ} 50' 19''$, an arc distance of 115.40 feet to a line parallel with and 78.00 feet east of, measured at right angles, the west line of said southwest quarter; thence
- 16) North $00^{\circ} 05' 00''$ East, a distance of 426.39 feet to the beginning of a tangent curve, concave westerly, with a radius of 1255.00 feet; thence
- 17) northerly, along the arc of said curve, through a central angle of $8^{\circ} 15' 14''$, an arc distance of 180.79 feet to a line parallel with and 65.00 feet east of, measured at right angles, the west line of said southwest quarter; thence
- 18) North $00^{\circ} 05' 00''$ East, along said parallel line and non-tangent to the last said curve, a distance of 885.44 feet to the True Point of Beginning.

Containing an area of 6.90 acres, more or less.

END OF DESCRIPTION



2010-085T
15-A-8784T
W.J. No. 5354

Date
Signed 2/7/14

EXHIBIT "D"

(PAGE 1 OF 2)



DATE SIGNED: 2/7/14

N.W. 1/4
SEC. 7
12/21

S.W. 1/4
SEC. 7
12/21

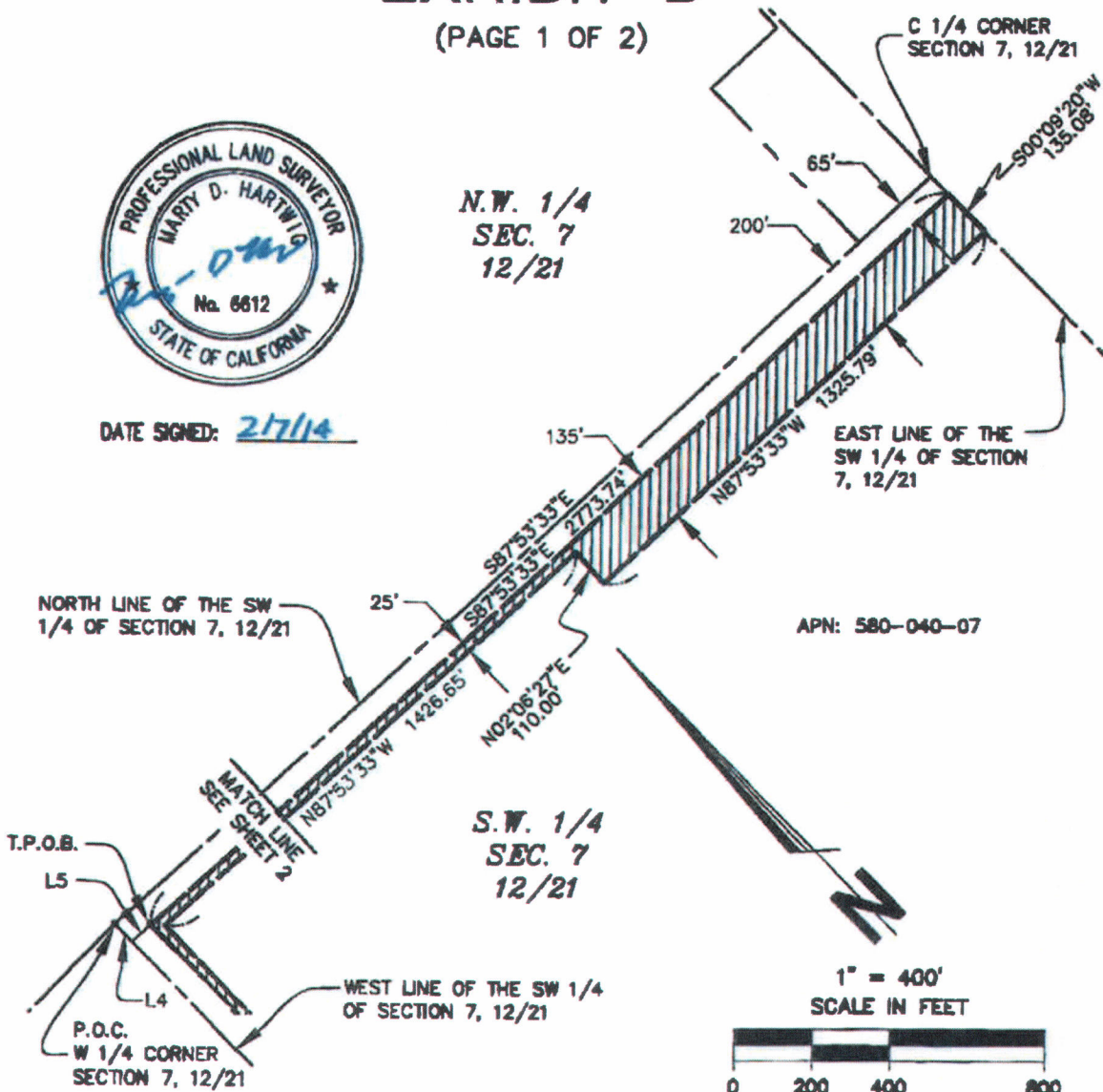

LEGEND



AREA FOR TEMPORARY CONSTRUCTION PURPOSES (6.90 ACRES)

P.O.C. POINT OF COMMENCEMENT

T.P.O.B. TRUE POINT OF BEGINNING

LINE TABLE		
LINE	BEARING	LENGTH
L4	S00°05'00"W	65.04
L5	S87°53'33"E	65.04

PROVOST & PRITCHARD

An American Correal Company
10000 N. GARDEN ST. SUITE 100
DALLAS, TEXAS 75243-2100
TEL: 972-242-8800 FAX: 972-242-8801

REF. & REV.
2010-085T
PLAT NO. 0384
WJ 5354

CITY OF FRESNO
DEPARTMENT OF PUBLIC WORKS

PORTION of
S.W. 1/4, SEC. 7, T.12 S., R.21 E., M.D.B. & M.
for TEMPORARY CONSTRUCTION PURPOSES

PROJ. ID. W000038
FUND NO. 40118
ORG. NO. 411501

DR. BY JDL
CH. BY MDH
DATE 06/29/12
SCALE 1" = 400'

SHEET NO. 1
OF 2 SHEETS
15-A-8784T

EXHIBIT "D"

(PAGE 2 OF 2)

LEGEND

-  AREA FOR TEMPORARY CONSTRUCTION PURPOSES (6.90 ACRES)
- P.O.C. POINT OF COMMENCEMENT
- T.P.O.B. TRUE POINT OF BEGINNING
- PREVIOUSLY GRANTED IN FEE SIMPLE TO THE COUNTY OF FRESNO BY THAT DEED RECORDED 9/29/1981 IN BOOK 7793 AT PAGE 275, O.R.F.C.

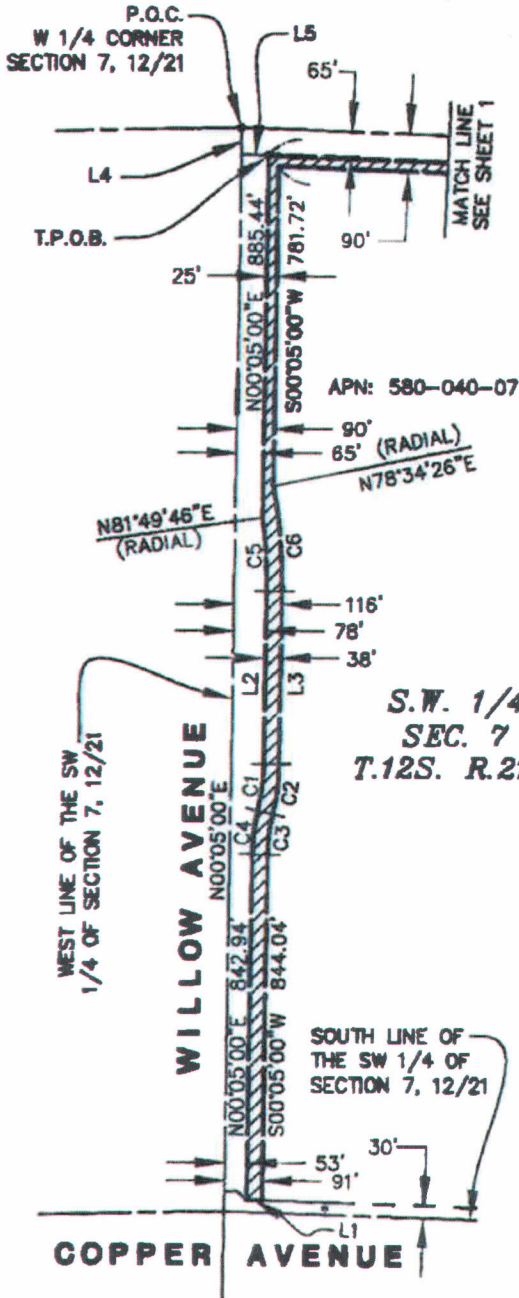

DATE SIGNED: 2/1/14
1" = 400'
SCALE IN FEET



CURVE TABLE			
CURVE	RADIUS	LENGTH	DELTA
C1	515.00	115.40	12°50'19"
C2	553.00	123.91	12°50'19"
C3	447.00	100.18	12°50'19"
C4	485.00	108.68	12°50'19"
C5	1255.00	180.79	8°15'14"
C6	1293.00	259.74	11°30'34"

LINE TABLE		
LINE	BEARING	LENGTH
L1	N88°14'58"W	38.02
L2	N00°05'00"E	426.39
L3	S00°05'00"W	426.39
L4	S00°05'00"W	65.04
L5	S87°53'33"E	85.04

PROVOST & PRITCHARD
REGISTERED PROFESSIONAL SURVEYORS
1000 W. MARKET STREET
FRESNO, CALIFORNIA 93701-4401
STATE OF CALIFORNIA LICENSE NO. 10000

REF. & REV. 2010-DBST PLAT NO. 0364 WJ 5354	CITY OF FRESNO DEPARTMENT OF PUBLIC WORKS	PROJ. ID. <u>WC00038</u> FUND NO. <u>4018</u> ORG. NO. <u>411501</u>	SHEET NO. <u>2</u> OF <u>2</u> SHEETS
	PORTION of S.W. 1/4, SEC. 7, T.12 S., R.21 E., M.D.B. & M. for TEMPORARY CONSTRUCTION PURPOSES	DR. BY <u>JDL</u> CH. BY <u>MDH</u> DATE <u>06/29/12</u> SCALE <u>1" = 400'</u>	15-A-8784T

EXHIBIT "E"

Page 1 of 1

**APN: 580-040-08 (Portion)
Pipeline Easement**

All of that portion of the southeast quarter of Section 7, Township 12 South, Range 21 East, Mount Diablo Base and Meridian, situate in the County of Fresno, State of California, according to the Official United States Government Township Plat thereof, being more particularly described as follows:

An easment for pipeline purposes 65.00 feet wide more particularly described as follows:

The northerly 65.00 feet of the westerly 47.00 feet of said southeast quarter.

Containing an area of 3,057 square feet, more or less.

END OF DESCRIPTION



Date
Signed 2/7/14

2010-084
15-A-8783
W.J. No. 5354

EXHIBIT "F"

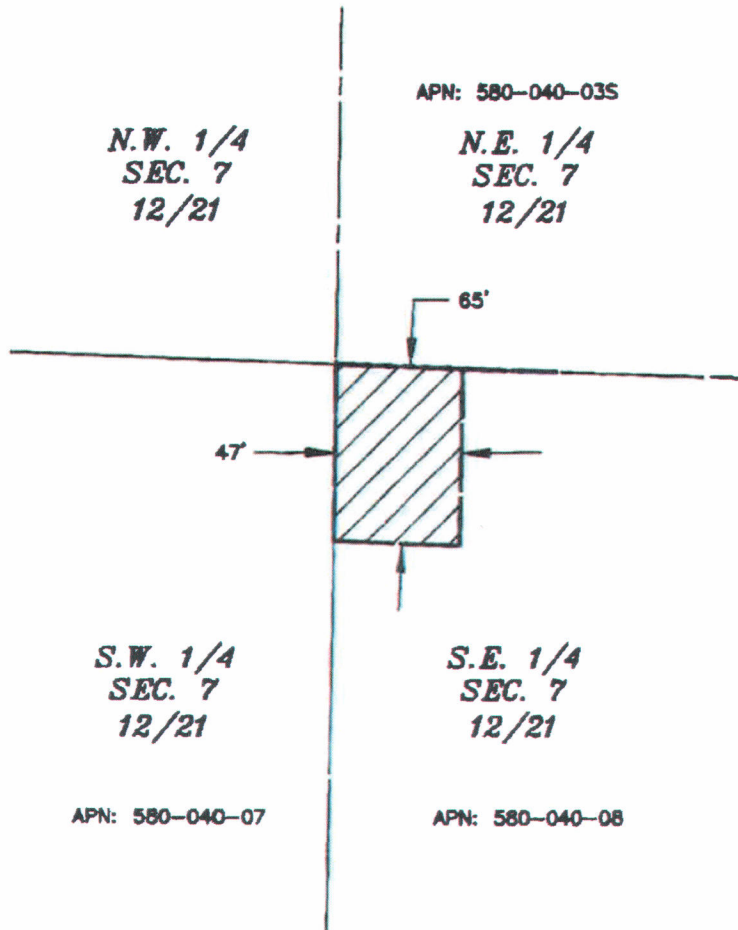

DATE SIGNED: 2/7/14



1" = 60'
SCALE IN FEET

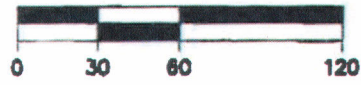

LEGEND

 AREA TO BE DEEDED FOR UNDERGROUND PIPELINE PURPOSES (3,057 SQ. FT.)

PROVOST & PRITCHARD
An Employee Owned Company

REF. & REV
2010-084
PLAT NO. 0002
WJ 5354

CITY OF FRESNO
DEPARTMENT OF PUBLIC WORKS

PROJ. ID. WC00038
FUND NO. 4011R
ORG. NO. 411501

PORTION of
S.E. 1/4, SEC. 7, T.12 S., R.21 E., M.D.B. & M.
To be Deeded for PIPELINE PURPOSES

DR. BY BMG
CHK. BY MDH
DATE 07/21/11
SCALE 1" = 60'

SHEET NO. 1
OF 1 SHEETS
15-A-8783

EXHIBIT "G"

Page 1 of 1

APN: 580-040-08 (Portion)
Construction Easement

All that portion of the Southeast quarter of Section 7, Township 12 South, Range 21 East, Mount Diablo Base and Meridian, situate in the County of Fresno, State of California, according to the Official United States Government Township Plat thereof, being more particularly described as follows:

An easement for construction purposes described as follows:

The northerly 200.00 feet of the westerly 72.00 feet of said southeast quarter.

EXCEPTING THEREFROM:

The northerly 65.00 feet of the westerly 47.00 feet of said southeast quarter.

Containing an area of 11,338 square feet, more or less.

END OF DESCRIPTION



Date
Signed 2/17/19

2010-084T
15-A-8783T
W.J. No. 5354

EXHIBIT "H"

APN: 580-040-03S

N.W. 1/4
SEC. 7
12/21

N.E. 1/4
SEC. 7.
12/21



DATE SIGNED: 2/7/14

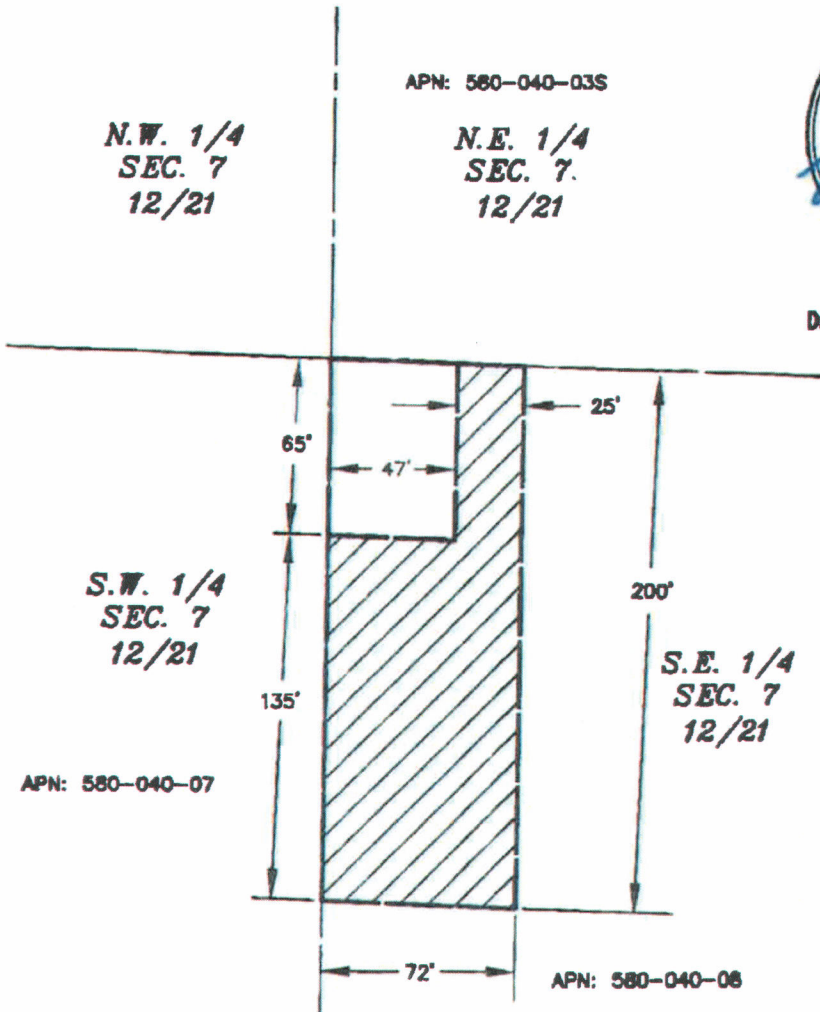

LEGEND

 AREA FOR TEMPORARY CONSTRUCTION PURPOSES (11,338 SQ. FT.)

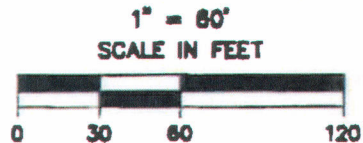

PROVOST & PRITCHARD
An Employee Owned Company

WE ARE QUALITY PEOPLE
PROVOST & PRITCHARD
SURVEYING & ENGINEERING
1500 N. G STREET, SUITE 100
FRESNO, CA 93703
(559) 233-1100

REF. & REV.
2010-084T

PLAT NO. 0002
WJ 5354

CITY OF FRESNO
DEPARTMENT OF PUBLIC WORKS

PORTION of
S.E. 1/4, SEC. 7, T.12 S., R.21 E., M.D.B. & M.
for TEMPORARY CONSTRUCTION PURPOSES

PROJ. ID. W000038
FUND NO. 40118
ORG. NO. 411501

DR. BY BMG
CH. BY MDH
DATE 07/21/11
SCALE 1" = 60'

SHEET NO. 1
OF 1 SHEETS
15-A-8783T

Exhibit 4 - Herold

- 4-A legal description/TCE/581-020-05s
- 4-B diagram/TCE/581-020-05s

EXHIBIT "A"

Page 1 of 1

APN: 581-020-05 (Portion)

Construction Easement

A portion of Lot 52 of Tract No. 2137 "Appaloosa Acres", recorded in Volume 23 of Plats, at Pages 66-67, Fresno County Records, situated in the northwest quarter of Section 4, Township 12 South, Range 21 East, Mount Diablo Base and Meridian, situate in the County of Fresno, State of California, according to the official United States Government Township Plat thereof, being more particularly described as follows:

An easement for construction purposes more particularly described as follows:

The northerly 150.00 feet of said Lot 52.

Containing an area of 2.19 acres, more or less.

END OF DESCRIPTION



Date
Signed 2/7/14

2010-115T
15-A-8787T
WJ NO. 5354

EXHIBIT "B"



DATE SIGNED: 2/7/14



1" = 150'
SCALE IN FEET

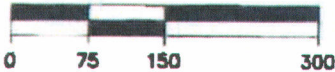

LOT 51
TRACT No. 2137
"APPALOOSA ACRES"
VOL. 23 OF PLATS
PGS. 66-67 F.C.R.

NORTH LINE OF LOT 52

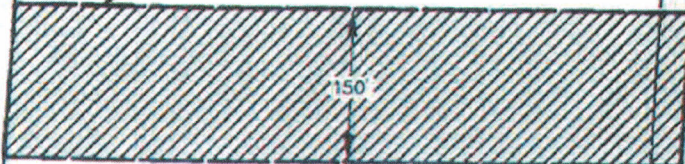

APN: 581-020-05

LOT 52
TRACT No. 2137

EAST LINE OF LOT 52

30'

SOUTH LINE OF LOT 52

LOT 53
TRACT No. 2137



LEGEND



AREA FOR TEMPORARY CONSTRUCTION PURPOSES (2.19 ACRES)

PROVOST & PRITCHARD

Professional Land Surveyors

DATE: 02/06/14

REF. & REV. 2010-115T PLAT NO. 0002 WJ 5354	CITY OF FRESNO DEPARTMENT OF PUBLIC WORKS	PROJ. ID: <u>WC00038</u> FLND NO. <u>40118</u> ORG. NO. <u>411301</u>	SHEET NO. <u>1</u> OF <u>1</u> SHEETS 15-A-87B7T
	PORTION of SEC. 4, T.12 S., R.21 E., M.D.B. & M. for TEMPORARY CONSTRUCTION PURPOSES	DR. BY: <u>BMG</u> CH. BY: <u>NOH</u> DATE: <u>02/06/14</u> SCALE: <u>1" = 150'</u>	

Exhibit 5 - Project Map

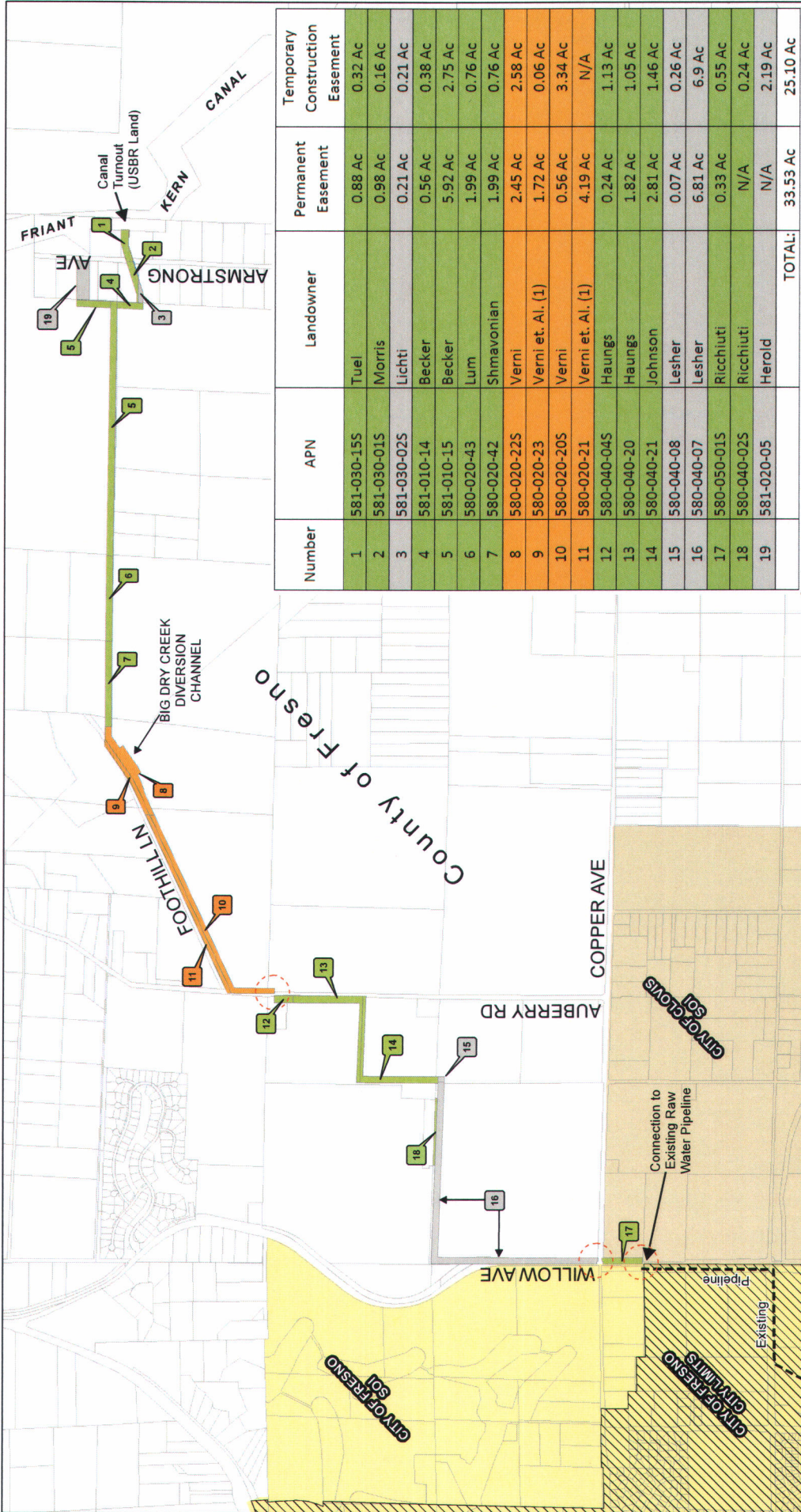

Raw Water Pipeline
City of Fresno

County RW Crossing

0 750 1,500 Feet

PROVOST & PRITCHARD
CONSULTING GROUP
An Employee-Owned Company

286 W. Crownwell Ave.
Fresno, CA 93711-6162
(559) 449-2700

Connection to Existing Raw Water Pipeline

Existing SWTF

Easements

- Currently in Escrow
- Reached Preliminary Agreement with Landowner
- Ongoing Negotiations with Landowners; RON Hearing Scheduled for 4/30/15
- Motion for Possession Filing Imminent
- Reached agreement with 5 owners. Ongoing negotiations with Vernis.

City of Fresno

Raw Water Pipeline
City of Fresno

Easement Status

Revised 4/01/15

Exhibit 6 - Fresno County authorization letter



Agenda Item

DATE: March 8, 2011

TO: Board of Supervisors

FROM: Alan Weaver, Director
Department of Public Works and Planning

SUBJECT: Request by the City of Fresno to Obtain Easements in the County along Auberry Road and Willow Avenue for Installation of a Raw Water Pipeline

RECOMMENDED ACTION:

Approve the City of Fresno's request to acquire variable width easements adjacent to existing road right-of-way in unincorporated areas of the County along both sides of Auberry Road and along the east side of Willow Avenue for installation of a raw water pipeline.

Approval of the recommended action will facilitate the City of Fresno's request to acquire easements in unincorporated areas for installation of public improvements in County areas. The City needs to increase the availability of domestic water to residents by installation of the pipeline from the Friant-Kern Canal to the City's surface water treatment facility located within the City of Fresno.

ALTERNATIVE ACTION:

There is no immediate alternative that is viable for this action. Denial of this action would result in the delay of easement acquisition for the project or necessitate that the City of Fresno pursue alternative alignments through the City of Clovis or pursue a widespread annexation of the area where improvements are proposed within the County.

FISCAL IMPACT:

There will be no net County cost for this recommended action. The City of Fresno has paid \$288.00 for processing of the request in accordance with the Master Schedule of Fees. The City of Fresno will acquire easements for construction of these improvements with no fiscal impact to the County.

ADMINISTRATIVE OFFICE REVIEW Bonnie O'Neil Page 1 of 8
BOARD ACTION: DATE March 8, 2011 APPROVED AS RECOMMENDED X OTHER _____



Official Action of Board of Supervisors

UNANIMOUS ANDERSON _____ CASE _____ LARSON _____ PEREA _____ POOCHIGIAN _____

The City of Fresno has indicated in their request (Exhibit "A") that they will maintain the improvements within these easement areas as required under applicable ordinance and code.

IMPACTS ON JOB CREATION:

Construction of the proposed raw water pipeline construction project will provide jobs and procurement of construction related materials within the metropolitan Fresno/Clovis area.

DISCUSSION:

The City of Fresno has requested, per Exhibit "A" attached, to acquire easements within the County. A proposed raw water pipeline project is to be constructed partially within Auberry Road north of Copper Avenue and along the east side of Willow Avenue both north and south of Copper Avenue adjacent to existing road rights-of-way and in areas reserved for future public improvement. The proposed pipeline will provide the community with a more reliable, secure and uninterrupted raw water conveyance system with improved water quality.

Section 1240 of the Code of Civil Procedure states that "... a local public entity may acquire by eminent domain only property within its territorial limits except where the power to acquire by eminent domain property outside its limits is expressly granted by statute or necessarily implied as an incident of one of its other statutory powers..." and "...except as otherwise expressly provided by statute and subject to any limitations imposed by statute, a local public entity may acquire property by eminent domain outside its territorial limits for water, gas, or electric supply purposes or for airports, drainage or sewer purposes if it is authorized to acquire property by eminent domain for the purposes for which the property is to be acquired...".

This action will require acquisition of easements within the County's jurisdiction, as indicated on Exhibits "B" & "C" and is consistent with the project improvement plans provided by the City. The City of Fresno will pay all associated costs for the pipeline construction and they will provide the required engineering and construction administration for the project. Acquisition of private property, outside of the future right-of-way, by the City to accommodate other easements where deemed necessary by their consultant are not part of this action.

The alignments of the raw water pipe proposed along Auberry Road and Willow Avenue are designed such that no adverse impacts will result if the County determines a need to widen these roads. Further, the depth of the proposed pipe has been set to be of sufficient depth to avoid possible conflict with any road related construction or maintenance operations.

Attached as Exhibit "D" is a letter from the City indicating their commitment to maintain the pipeline and its appurtenances. Any work needed to facilitate the installation of the pipeline within the County's existing right-of-way will be processed through an encroachment permit.

OTHER REVIEWING AGENCIES:

This item has been initiated at the written request of the City of Fresno. A copy of this Agenda Item has been provided to the City of Fresno.

EXHIBIT "A"



Department of Public Utilities

Water Division
1910 East University Avenue
Fresno, California 93703-2927
559-621-5300 – FAX 559-488-1024
www.fresno.gov

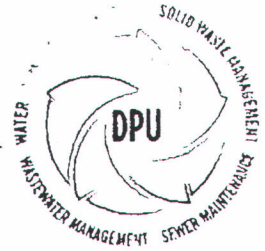

Providing Life's Essential Services

October 18, 2010

Mr. Dan Gibbs, P.E.
Supervising Eng/Asst. Div. Mgr.
County of Fresno
2220 Tulare St
Fresno, CA 93721

RE: Notification of Acquiring Right of Way for the City of Fresno Raw Water Pipeline Project

This letter is to serve as notification of acquiring right of way within County of Fresno areas on behalf of the City of Fresno for the City's Raw Water Pipeline Project. Enclosed is a check in the amount of \$288.00 for processing this notification, as required by Exhibit B of the Fresno County Master Schedule of Fees, Charges, and Recovered Costs, Section 2205. Miscellaneous Fees, Item I. Right of Way/ Traffic Control Permission Fee.

Project Summary

The City of Fresno plans to construct a pipeline that will deliver water from the Friant-Kern Canal (FKC) to the City's Surface Water Treatment Facility (SWTF) located in northeast Fresno near the corner of Chestnut and Behymer Avenues. The City completed an alignment alternative analysis and identified the preferred alignment for the project. The project vicinity is shown in the attached exhibit.

Water is currently conveyed to the SWTF from the Friant Kern Canal via the Enterprise Canal which is operated and maintained by Fresno Irrigation District. The Enterprise Canal route meanders through approximately 26 miles of various agricultural and urban land uses before reaching the SWTF. The proposed pipeline will reduce the travel distance from the Friant Kern Canal to the SWTF to approximately 5 miles. Approximately 1 mile of this pipeline was previously constructed within City limits during construction of the Clovis Unified School District and SCCCDCD campuses in 2006. The remaining length of pipeline (approx. 4 miles) will be constructed as part of the Raw Water Pipeline project. The pipeline will be 60-inches in diameter. Where the pipeline crosses private property, a permanent pipeline easement width of 65 feet is required. Along with this permanent easement, a temporary construction easement of 35 feet will be necessary. In areas along road rights-of-way, the pipeline will be constructed within the ultimate planned right-of-way, or landscape area. The easement locations, property owners, and other data are delineated in the attached exhibit.

Project Background

The City of Fresno completed construction of its Surface Water Treatment Facility (SWTF) located in the northeast portion of Fresno in 2004. The SWTF began treating surface water in June 2004 and currently delivers between 15 and 30 percent of the water supply to the City's water distribution system. The City had previously relied solely on groundwater for potable water supply. The SWTF is currently supplied with Kings River and Central Valley Project (CVP) water conveyed by the Fresno Irrigation District's Enterprise Canal.

There are capacity limitations and water quality vulnerability concerns along the Enterprise Canal that require significant improvements for long-term use. The Enterprise Canal is also taken out of operation for approximately one month each year for maintenance, so the SWTF cannot be operated during that time. The proposed pipeline will provide the City with a more secure, uninterrupted conveyance system with improved water quality, and bring supply directly from the FKC to the SWTF.

The pipeline is being constructed to:

- Provide a more reliable supply to the City's SWTF, 365-days per year
- Provide redundancy of supply, by making the new pipeline the primary supply source and the Enterprise Canal the backup supply source
- Provide improved water quality protection, including protection from malicious acts
- Reduce treatment chemical costs utilizing improved quality water
- Reduce power consumption by taking advantage of gravity flow from the FKC to the SWTF, eliminating the use of raw water pumps at the SWTF

Project Schedule and Closing

In regards to project schedule, the project environmental document (CEQA/NEPA) is well underway and we hope to make it available for public review and comment shortly. The easement exhibits are still in the process of being prepared by our consultant and reviewed by City Staff, therefore, they are not yet ready to be made public. We understand there is a lead time for this type of notification to be processed through the County of Fresno; however, we would appreciate the County's prompt consideration and response to this matter.

As you are aware, the County has reviewed the preliminary plans and provided comments. The City's consultants are revising the project plans, and the City of Fresno is planning to submit initial offer letters to landowners to initiate the acquisition process in the next few weeks. If there is anything further needed to process this request, please contact me at (559) 621-5484.

Sincerely,



Cesar Romero, PE
City of Fresno
Department of Public Utilities – Water Division

Attachment – Exhibit: Easement Locations

CC: Brock Buche, P.E., City of Fresno Water Division
Ron Samuelian, P.E., Provost & Pritchard

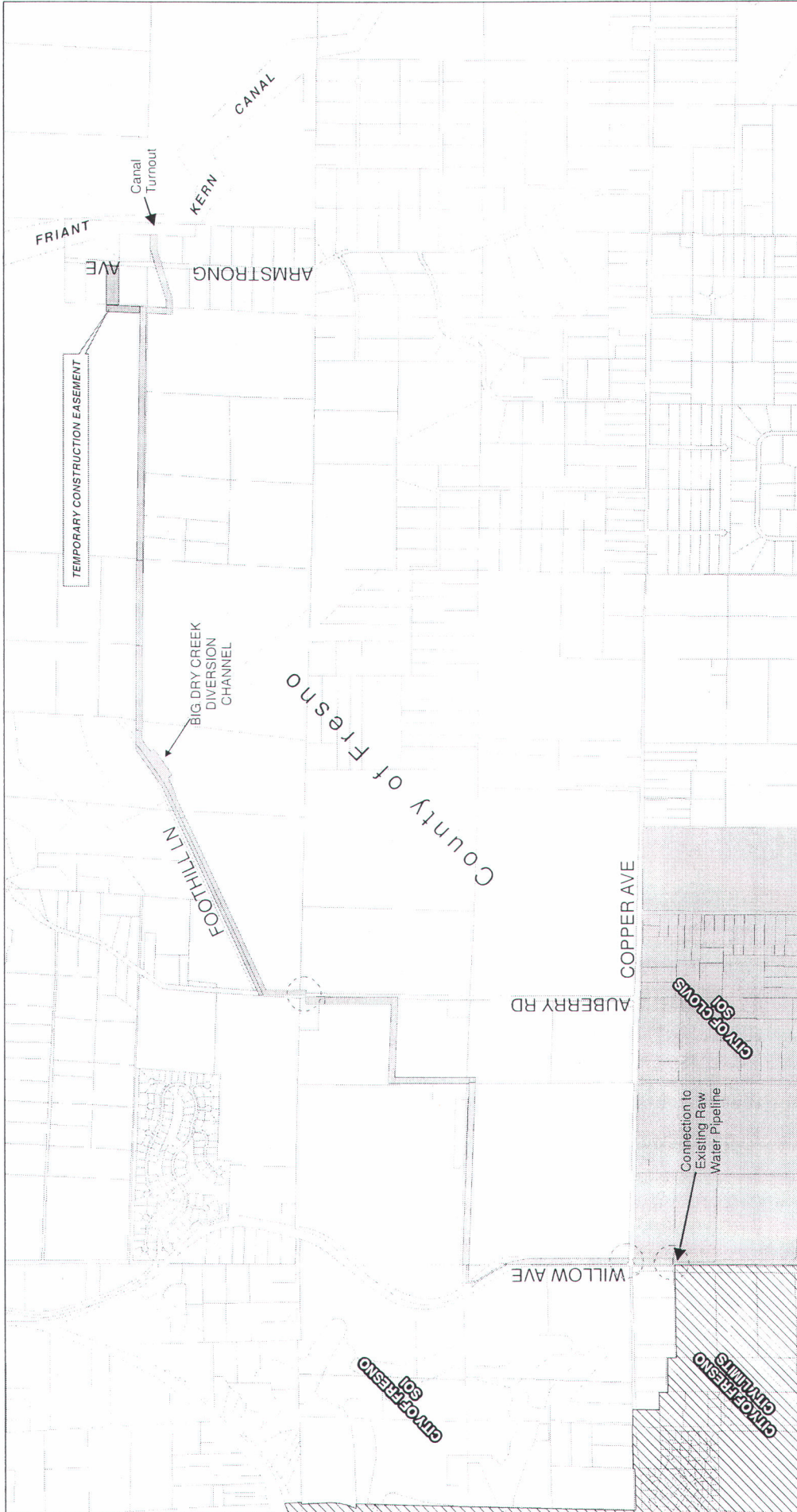

**Raw Water Pipeline
City of Fresno**

Easement Locations

Revised 01-25-2011

Legend

- Fresno Co. Parcel
- Pipeline Alignment
- County RW Crossing



0 750 1,500 Feet

PROVOST & PRITCHARD
 286 W. Cromwell Ave.
 Fresno, CA 93711-6162
 (559) 449-2700

2-4-2011 \p09nell\dwg_dgn\Clients\UCP_Tierra Del Rey.LLC - 2047\Tract 5753_Tierra Del Rey_WSA\WSGIS\Mapsurvey_easement_algn.mxd

EXHIBIT "B"

LEGEND

-  AREA TO BE DEEDED FOR UNDERGROUND PIPELINE PURPOSES
-  AREA FOR TEMPORARY CONSTRUCTION PURPOSES

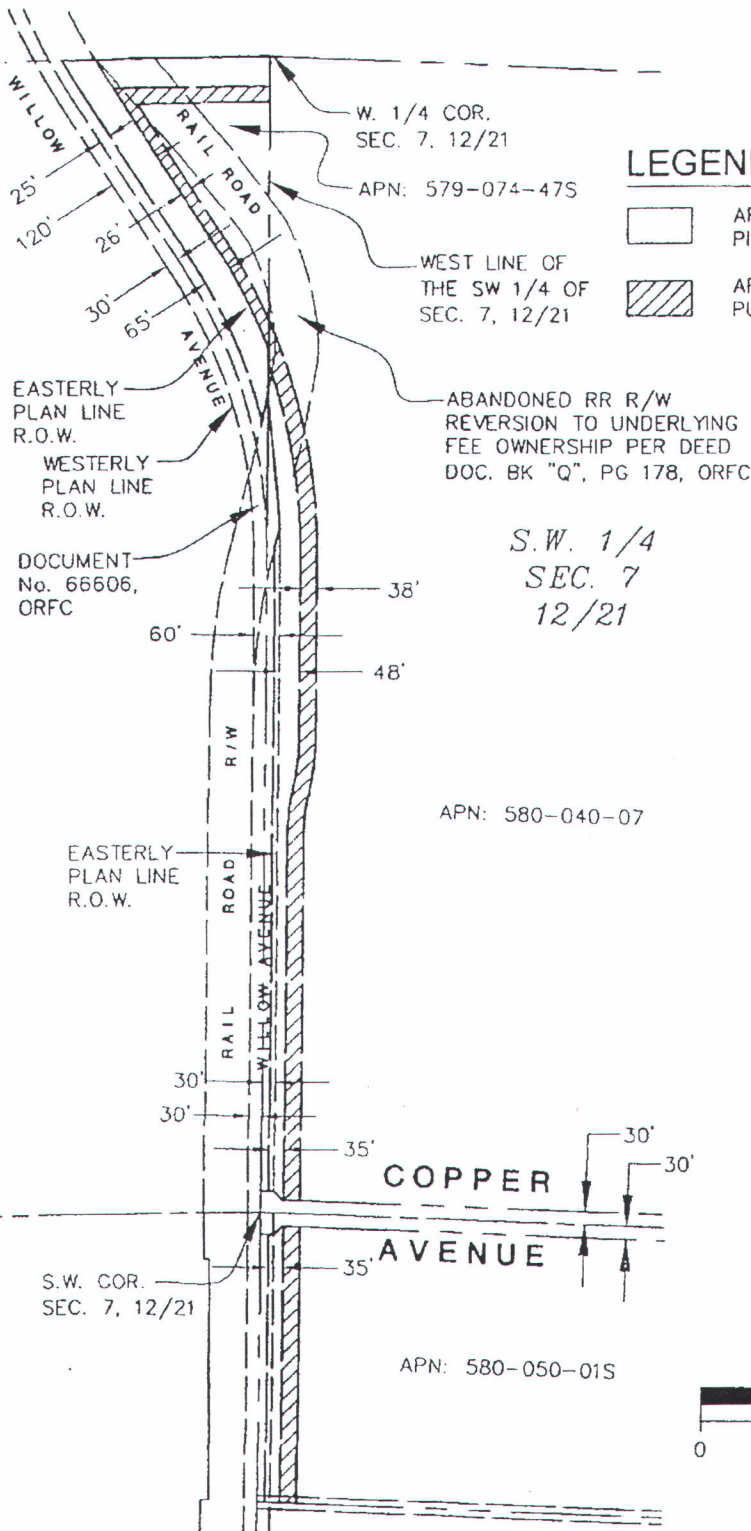

1" = 400'
SCALE IN FEET



PROVOST & PRITCHARD
CAMPBELL, THOMAS & COMPANY
An Estimating Owned Company
200 N. G STREET, SUITE 100
FRESNO, CALIFORNIA 93701-4242
208/448-7200 FAX 208/448-4700
www.provost.com

CITY OF FRESNO
DEPARTMENT OF PUBLIC WORKS

PORTION
ALONG WILLOW AVENUE
To be Deeded for PIPELINE PURPOSES

PROJ. ID. WC00038
FUND NO. 40118
ORG. NO. 411501



DR. BY SJO
CH. BY SFR
DATE 01/25/11
SCALE 1" = 400'

SHEET NO. 1
OF 1 SHEETS

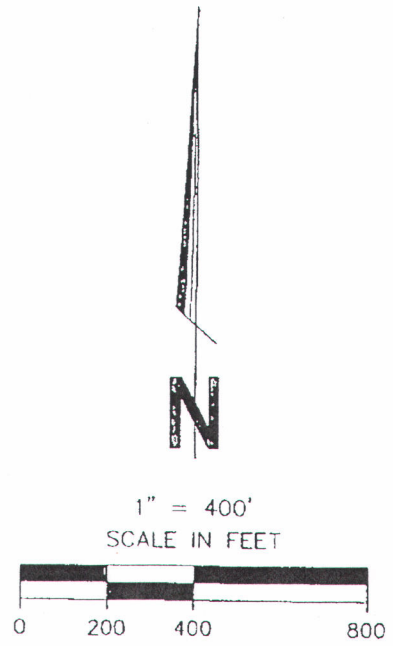
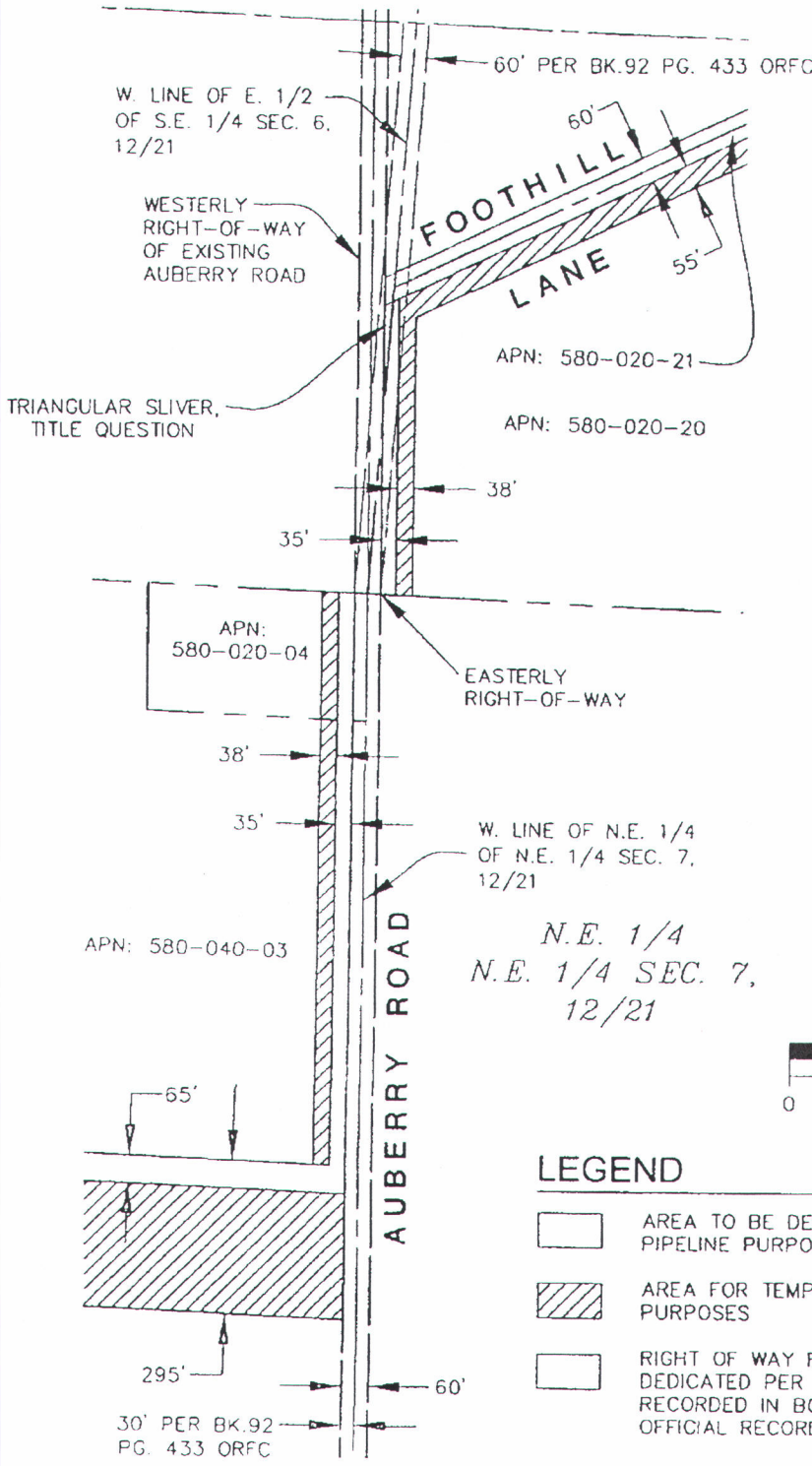
EXHIBIT "C"



LEGEND

-  AREA TO BE DEEDED FOR UNDERGROUND PIPELINE PURPOSES
-  AREA FOR TEMPORARY CONSTRUCTION PURPOSES
-  RIGHT OF WAY FOR PUBLIC ROAD DEDICATED PER DEED DOCUMENT RECORDED IN BOOK 92, PAGE 433, OFFICIAL RECORDS FRESNO COUNTY

Provost & Pritchard
 CIVIL ENGINEERS
 An Employee Owned Company
 200 WEST OGDEN STREET
 FRESNO, CALIFORNIA 93704-1012
 204/180-7700 FAX 204/180-7703
 www.ppeng.com

CITY OF FRESNO DEPARTMENT OF PUBLIC WORKS	PORTION ALONG AUBERRY ROAD To be Deeded for PIPELINE PURPOSES	PROJ. ID. <u>WC00038</u> FUND NO. <u>4018</u> ORG. NO. <u>411501</u>	SHEET NO. <u>1</u> OF <u>1</u> SHEETS
	DR. BY <u>SJD</u> CH. BY <u>SFR</u> DATE <u>01/25/11</u> SCALE <u>1" = 400'</u>		

EXHIBIT "D"



Department of Public Utilities

Water Division
1910 East University Avenue
Fresno, California 93703-2927
559-621-5300 – FAX 559-488-1024
www.fresno.gov

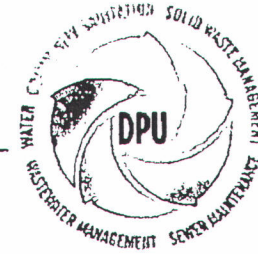

Providing Life's Essential Services

January 26, 2011

Mr. Dan Gibbs, P.E.
Supervising Eng/Asst. Div. Mgr.
County of Fresno, Public Works and Planning Department
2220 Tulare St, Annex B
Fresno, CA 93721

**SUBJECT: EXHIBIT D - PIPELINE MAINTENANCE LETTER
CITY OF FRESNO RAW WATER PIPELINE PROJECT**

The City of Fresno Department of Public Utilities – Water Division (City) previously submitted a notification letter to County of Fresno staff (dated October 18, 2010) regarding right of way acquisition within County of Fresno areas on behalf of the City for the Raw Water Pipeline Project (PROJECT). That notification included exhibits requested by County of Fresno staff as well as payment in the amount of \$288.00 for processing the notification.

During preparation of the County Board of Supervisors Agenda Item report, County staff requested that the City provide a letter indicating the City's commitment to maintain the proposed pipeline and its related appurtenances.

The City agrees that maintenance of the PROJECT improvements can best be performed by one agency, and the City agrees to perform all maintenance for the PROJECT improvements installed along the PROJECT alignment within the PROJECT easements. The City also requests that they be granted sole reviewing and approval authority for improvement projects which occur within the PROJECT easements. The City also requests that all street and utility work permits be issued by the City for work to be done within the area of the PROJECT easements.

It should be noted, the pipeline will be designed, constructed, operated, maintained, and inspected to meet and/or exceed the current industry standard of practice and appropriate factors of safety will be incorporated into the pipeline design to ensure the reliability and service life of the pipeline and its appurtenances.

Please contact Brock Buche, P.E., at 559-621-5325 if you need additional information.

Sincerely,

A handwritten signature in black ink, appearing to read "Cesar Romero".

Cesar Romero, PE
City of Fresno
Department of Public Utilities – Water Division