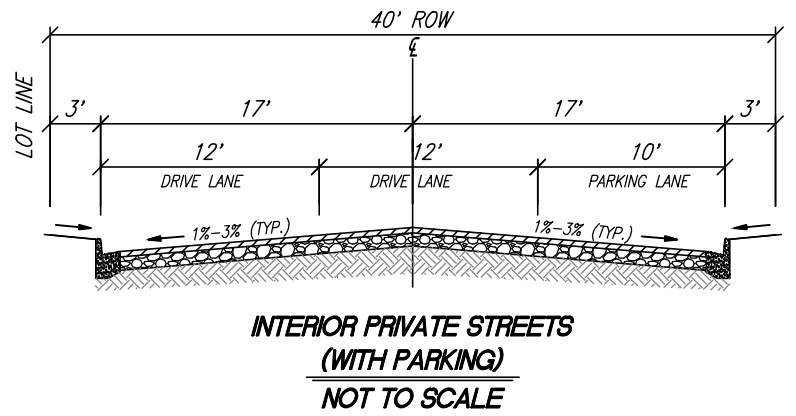
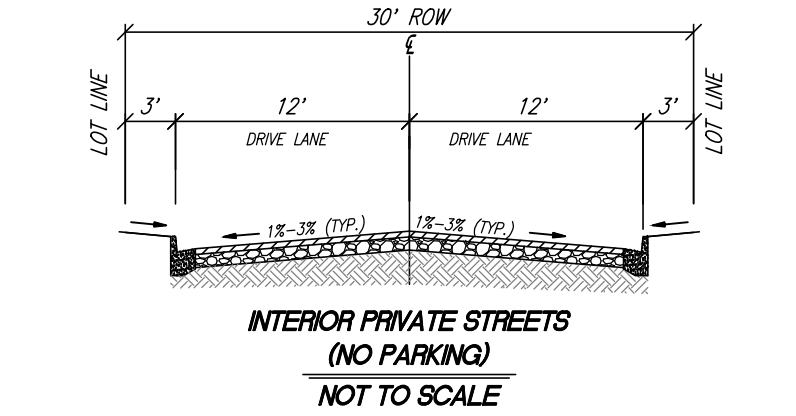
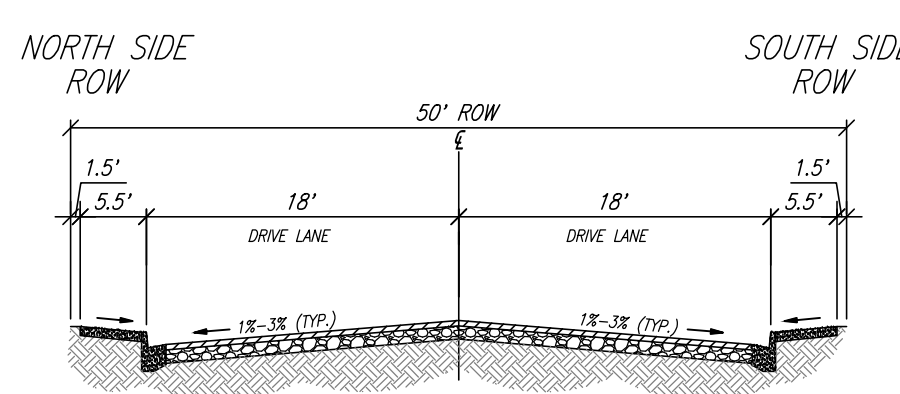
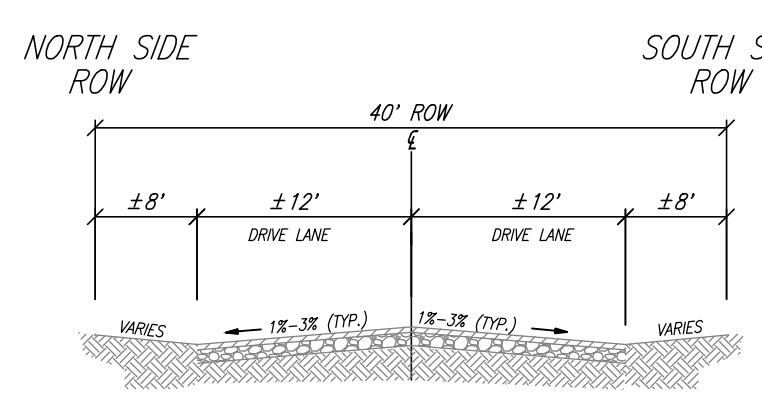
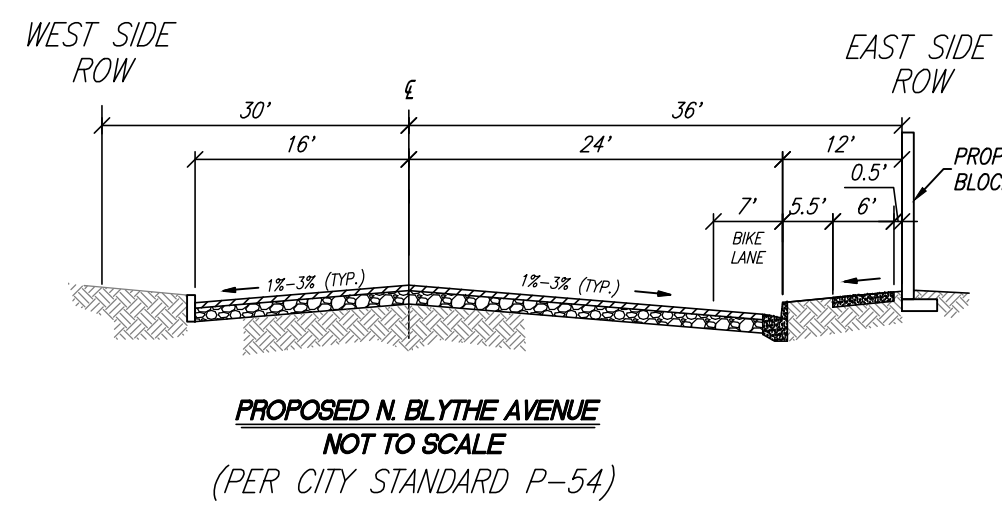
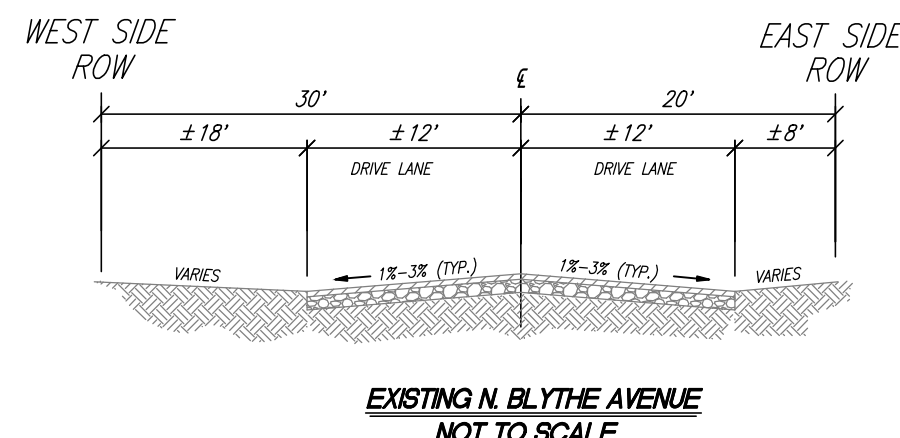
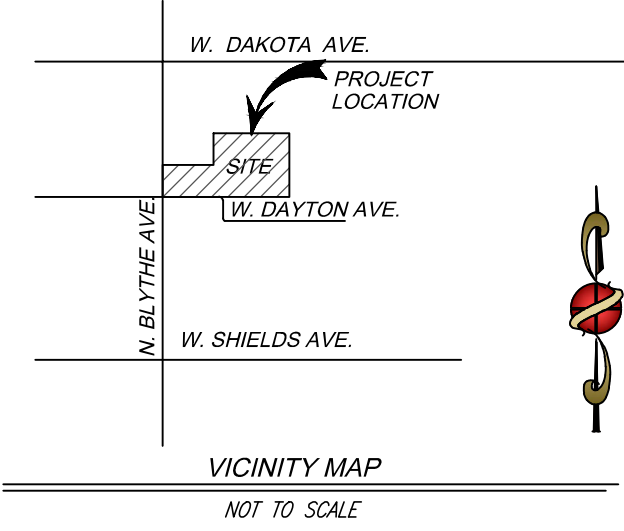

Exhibit A

VESTING TENTATIVE SUBDIVISION MAP TRACT MAP NO. 6192

IN THE CITY OF FRESNO
FRESNO COUNTY, CALIFORNIA
PREPARED ON SEPTEMBER 7, 2023
REVISED ON JUNE 19, 2024
SHEET 1 OF 1



LEGEND	
PUE	PUBLIC UTILITY EASEMENT
LE	LANDSCAPE EASEMENT
ROW	RIGHT OF WAY
△	INDICATES EXISTING PRESCRIPTIVE RIGHT-OF-WAY
▲	INDICATES EXISTING RIGHT-OF-WAY PREVIOUSLY DEDICATED PER DEED RECORDED IN BOOK 6397, PAGE 453, O.R.F.C.
▲▲▲▲▲	WAIVER OF DIRECT ACCESS
⊗	EXISTING WATER VALVE
⊙	EXISTING CONCRETE IRRIGATION STANDPIPE
⊕	EXISTING POWER POLE
⊖	EXISTING TRANSFORMER POLE
⊗	EXISTING TELEPHONE POLE
⊗	EXISTING BOLLARD (TO BE REMOVED)
⊗	EXISTING MAILBOX (TO REMAIN)
⊗	EXISTING SIGN
---	SECTION LINE
---	EXISTING RIGHT OF WAY
---	SUBJECT PROPERTY BOUNDARY
---	EXISTING EDGE OF PAVEMENT (TO BE REMOVED)
---	EXISTING OVERHEAD ELECTRICAL LINE
---	EXISTING CHAIN LINK FENCE
---	EXISTING WROUGHT-IRON FENCE
---	EXISTING BARBED WIRE FENCE
---	PROPOSED LOT LINE
---	PROPOSED CENTERLINE
---	PROPOSED SIX-FOOT MASONRY WALL

SITE INFORMATION

GENERAL PLAN LAND USE DESIGNATION: MEDIUM DENSITY RESIDENTIAL

EXISTING USE: VACANT PARCEL

EXISTING ZONING: RS-5/UGM (RESIDENTIAL-SINGLE FAMILY/ URBAN GROWTH MANAGEMENT)

SITE ACREAGE: GROSS: ± 16.05 AC
NET: ± 15.82 AC

NUMBER OF LOTS: 128

AVERAGE LOT AREA: 4,060 SQ. FT.

DENSITY: 8.1 UNITS PER ACRE

ASSASSOR'S PARCEL NUMBER: 511-031-425

SITE LOCATION: NORTHEAST CORNER OF N. BLYTHE AVENUE AND W. DAYTON AVENUE, FRESNO, CA 93722

OWNER/SUBDIVIDER: DR. HORTON, 7825 N. PALM AVE, FRESNO, CA 93711, PH: 559-436-4467

ENGINEER: PRECISION CIVIL ENGINEERING, INC, 1234 'O' ST., FRESNO, CA 93727, PH: 559-449-4500

APPL. NO. T-6192 EXHIBIT A DATE 06/20/2024

PLANNING REVIEW BY _____ DATE _____

TRAFFIC ENG. _____ DATE _____

APPROVED BY _____ DATE _____

CITY OF FRESNO DARM DEPT

- NOTES**
- THERE ARE NO EXISTING TREES OR STRUCTURES UNSITE.
 - MEDIUM DENSITY RESIDENTIAL USE IS INTENDED ON ALL PARCELS OF THE PROPOSED TRACT MAP.
 - ALL BUILDING SETBACKS SHALL BE IN ACCORDANCE WITH CITY OF FRESNO ZONING CODES.
 - ALL UTILITY SERVICES ARE PROPOSED TO BE PROVIDED BY THE FOLLOWING AGENCIES:
 - SANITARY SEWER: CITY OF FRESNO
 - STORM DRAINAGE: FIMCO
 - DOMESTIC WATER: CITY OF FRESNO
 - FIRE PROTECTION: CITY OF FRESNO
 - ELECTRICITY: PG&E
 - PHONE: AT&T
 - TELEPHONE: AT&T
 - CABLE: COMCAST
 - WASTE DISPOSAL: CITY OF FRESNO
 - NO GRADE DIFFERENCES OF 6" OR MORE EXIST ADJACENT TO THE PROPERTY.
 - SOURCE OF DATA: PARCEL MAP NO. 1528 BK 7, PG 69, FRESNO COUNTY RECORDS.
 - TRACT MAP PROVIDES FOR BUILDINGS WITH SOUTHERN EXPOSURE FOR NATURAL HEATING DURING THE WINTER MONTHS, WITH AMPLE SPACE FOR DECIDUOUS SHADE TREES FOR NATURAL COOLING DURING THE SUMMER MONTHS.
 - PROPOSED STREET IMPROVEMENTS SHALL BE INSTALLED IN CONFORMANCE WITH LOCAL AGENCY STANDARDS AND/OR ANY MINOR MODIFICATIONS APPROVED BY THE LOCAL AGENCY.
 - ALL PUBLIC UTILITIES (PO&E, SBC, COMCAST, WATER AND SEWER) SHALL BE INSTALLED.
 - ALL IMPROVEMENTS PROPOSED (SEWER, WATER, STORM DRAIN, CURB, GUTTER, STREETS/LIGHTS, SIDEWALK, AND PERMANENT PAVEMENT) SHALL BE CONSTRUCTED TO CITY STANDARDS.
 - THIS TRACT IS NOT WITHIN 200 FEET OF ANY RAILROAD, FREEWAY OR EXPRESSWAY.
 - NO CANALS OR PRIVATE DITCHES PRESENT ON SITE.
 - 8,332 SF (0.24 ACRES) OPEN SPACE PROVIDED (OPEN SPACE REQUIRED: 0.001884 ACRE X 128 UNITS = 0.24 ACRES, PER ORDINANCE NO. 2016-57)
 - NO UNDERGROUND FEATURES SUCH AS PRIVATE WELLS, CESSPOOLS, SEPTIC SYSTEMS, DUMP SITES, OR OTHER UNDERGROUND STRUCTURES ARE PRESENT.
 - FOR LOTS WHERE THE STREET SIDE YARD FACES THE FRONT YARD A MINIMUM LANDSCAPE EASEMENT OF FIVE FEET IS REQUIRED, UNLESS A FOUR FOOT PARK STRIP IS PROVIDED BETWEEN THE CURB AND SIDEWALK. A MINIMUM SIX-FOOT MASONRY WALL SHALL BE PLACED AT THE REAR OF THE LANDSCAPE EASEMENT. AN OPENING IN THE MASONRY WALL MAY BE PERMITTED TO PROVIDE A GATE FOR ACCESS IF APPROVED BY THE PUBLIC WORKS DIRECTOR. THIS NOTE PERTAINS TO LOTS 1, 13, 14, 26, 38, AND 39.

LEGAL DESCRIPTION

THE LAND REFERRED TO HEREIN BELOW IS SITUATED IN THE CITY OF FRESNO, COUNTY OF FRESNO, STATE OF CALIFORNIA AND IS DESCRIBED AS FOLLOWS:

THE SOUTH HALF OF THE NORTHWEST QUARTER OF THE SOUTHWEST QUARTER OF SECTION 23, TOWNSHIP 13 SOUTH, RANGE 19 EAST, MOUNT Diablo BASE AND MERIDIAN, ACCORDING TO THE OFFICIAL PLAT THEREOF.

EXCEPTING THEREFROM THE NORTH 330 FEET OF THE WEST 528 FEET THEREOF.

APN : 511-031-425

AREA : 16.05 ACRES (MORE OR LESS)

OUTLOT NOTES

OUTLOT 'A' TO BE DEDICATED FOR OPEN SPACE PURPOSES.

SCALE 1" = 60'

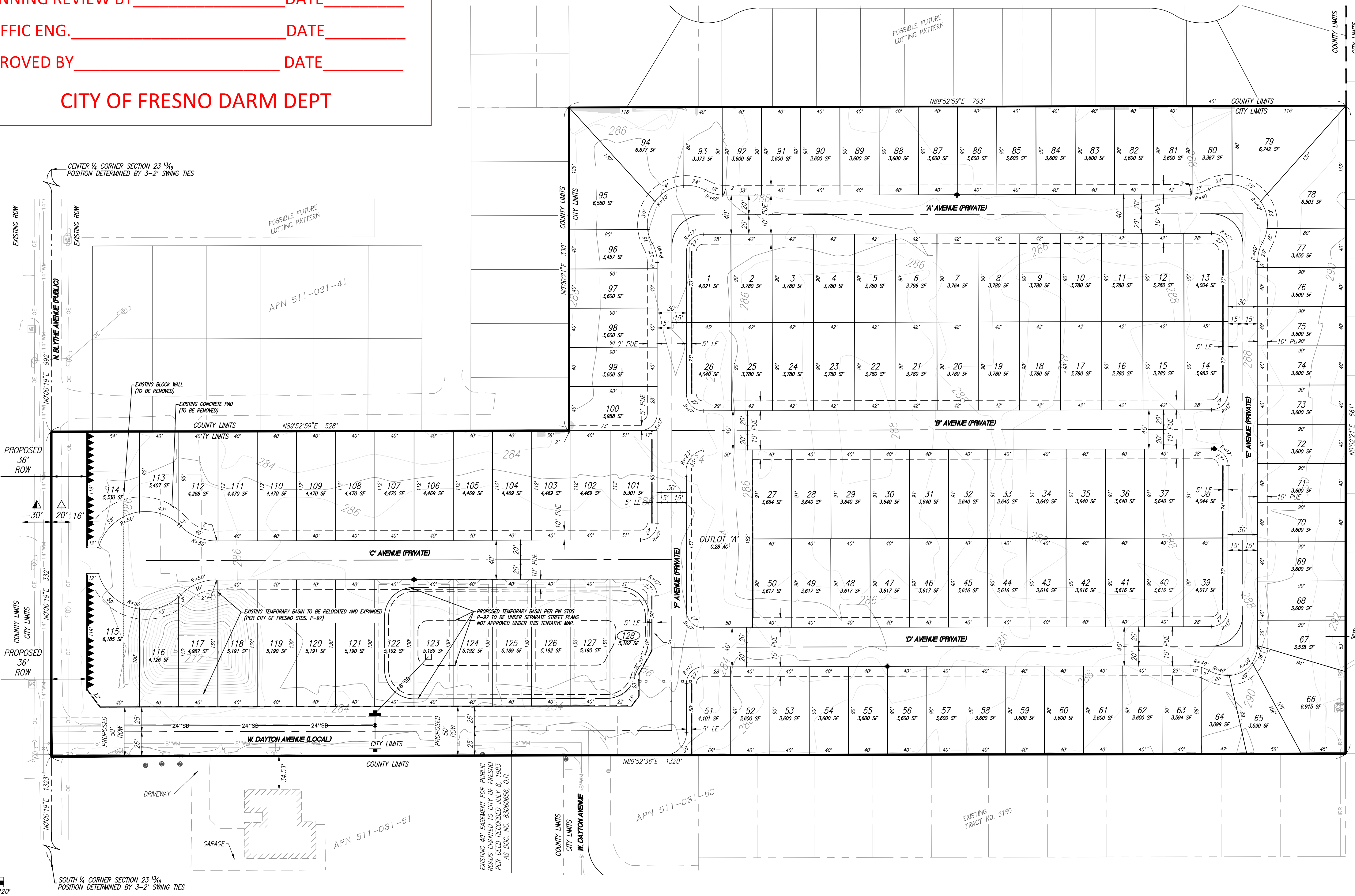

PRECISION CIVIL ENGINEERING, INC.

PLANNING SURVEYING CIVIL ENGINEERING
1234 O STREET, FRESNO, CALIFORNIA 93721
TEL: 559-449-4500 FAX: 559-449-4515
WWW.PRECISIONENG.COM

PROJECT TITLE: N. BLYTHE AVE. AND W. DAYTON AVE.

SHEET DESCRIPTION: TENTATIVE TRACT MAP 6192

CITY OF: FRESNO

PREPARED FOR: DR. HORTON, 7825 N. PALM AVE, FRESNO, CA 93711, (559) 436-4467

REVISIONS:

DRAWN BY: LC
CHECKED BY: JL
DATE: 6/20/2024

SHEET NUMBER: 1 OF 1

JOB NUMBER: 23-111