

**AGREEMENT FOR PURCHASE AND SALE OF EASEMENTS
AND ESCROW INSTRUCTIONS
Fresno Area Express Project
Easements Fresno Street and Van Ness Avenue - Courthouse Park
City Project No.: FC00049**

COUNTY OF FRESNO, a political subdivision of the State of California ("County"), hereby agrees to sell to the CITY OF FRESNO, a municipal corporation ("City"), the hereinafter described permanent easements and temporary construction easements on the following terms and conditions:

1. The real property easements which are the subject of this Agreement are situated in the City of Fresno, County of Fresno, State of California and may hereinafter for convenience be referred to as the "Subject Property," being permanent easements (11,947 square feet) and temporary construction easements (4,257 square feet) for a total of approximately 16,204 square feet in size and located on Fresno Street and Van Ness Avenue in the County of Fresno Courthouse Park, contained within Assessor's Parcel Number 466-160-01T and more particularly described in the Deed of Easement, attached hereto as Exhibit "1" and the Temporary Construction Easement attached hereto as Exhibit "2", both of which are incorporated herein by reference and made a part hereof.

2. The total purchase price for the Subject Property shall be the sum of ONE HUNDRED THIRTY-ONE THOUSAND, ONE HUNDRED AND 00/100 DOLLARS (\$131,100).

3. It is understood and agreed by and between the parties hereto that the easements described in Exhibit "1" are permanent easements, and the easements described in Exhibit "2" are one year temporary easements for construction purposes. All such easements are necessary for the City to reconstruct the existing bus shelters located at Fresno Courthouse Park.

4. County represents and warrants that it holds fee title to the real property from which said easements shall issue and can convey the Subject Property.

5. City shall indemnify, hold harmless and defend County and each of its officers, officials, employees, agents and volunteers from any and all loss, liability, fines, penalties, forfeitures, costs and damages (whether in contract, tort or strict liability, including but not limited to personal injury, death at any time and property damage) incurred by County, City or any other person, and from any and all claims, demands and actions in law or equity (including attorney's fees and litigation expenses), arising or alleged to have arisen directly or indirectly from the negligent or intentional acts or omissions, or willful misconduct of City or any of its officers, officials, employees, agents or volunteers in the performance of this Agreement; provided nothing herein shall constitute a waiver by City of governmental immunities including California Government Code section 810 et seq.

County shall indemnify, hold harmless and defend City and each of its officers, officials, employees, agents and volunteers from any and all loss, liability, fines, penalties, forfeitures, costs and damages (whether in contract, tort or strict liability, including but not

limited to personal injury, death at any time and property damage) incurred by the City, County or any other person, and from any and all claims, demands and actions in law or equity (including attorney's fees and litigation expenses), arising or alleged to have arisen directly or indirectly from the negligent or intentional acts or omissions, or willful misconduct of County or any of its officers, officials, employees, agents or volunteers in the performance of this Agreement; provided nothing herein shall constitute a waiver by County of governmental immunities including California Government Code section 810 et seq.

In the event of concurrent negligence on the part of City or any of its officers, officials, employees, agents or volunteers, and County or any of its officers, officials, employees, agents or volunteers, the liability for any and all such claims, demands and actions in law or equity for such losses, fines, penalties, forfeitures, costs and damages shall be apportioned under the State of California's theory of comparative negligence as presently established or as may be modified hereafter.

This section shall survive termination or expiration of this Agreement.

6. Upon completion of construction, City will restore the real property to the original condition, subject to the permanent easements described herein.

7. The sale shall be completed through an escrow to be opened at Fidelity National Title Company, 7485 North Palm Avenue, Suite 106, Fresno, California 93711 ("Escrow Holder") under Escrow Number 2011603225-BW. Said escrow shall be opened upon the following terms and conditions, and the County and City by executing this Agreement make this paragraph their escrow instructions:

- a. City shall deposit the sum specified in Paragraph 2 of this Agreement and all closing costs in escrow, upon receipt of a demand and statement from said title company therefor.
- b. Payment of said sum will be made to County only when Escrow Holder possesses and is in a position to deliver to the City a fully executed and acknowledged and recorded Deed of Easement in the form of Exhibit "1", as regards the permanent easements.
- c. The escrow fee, recording fees (if any), and all other closing costs shall be paid 100% by the City.

8. Miscellaneous Provisions:

- a. Waiver. The waiver by either party of a breach by the other of any provision of this Agreement shall not constitute waiver or a waiver of any subsequent breach of either the same or a different provision of this Agreement. No provision of this Agreement may be waived unless in writing and signed by all parties to this Agreement. Waiver of any one provision herein shall not be deemed to be a waiver of any other provision herein.
- b. Governing Law and Venue. This Agreement shall be governed by, and construed and enforced in accordance with, the laws of the State of California. Venue for purposes of the filing of any action regarding the enforcement or interpretation of this Agreement any rights and duties hereunder shall be in the County of Fresno, California.

- c. Headings. The section headings in this Agreement are for convenience and reference only and shall not be construed or held in any way to explain, modify or add to the interpretation or meaning of the provisions of this Agreement.
- d. Severability. The provisions of this Agreement are severable. The invalidity or unenforceability of any one provision in this Agreement shall not affect the other provisions.
- e. Interpretation. The parties acknowledge that this Agreement in its final form is the result of the combined efforts of the parties and that, should any provision of this Agreement be found to be ambiguous in any way, such ambiguity shall not be resolved by construing this Agreement in favor of or against any party, but rather by construing the terms in accordance with their generally accepted meaning.
- f. Attorney's Fees. If either party is required to commence any proceeding or legal action to enforce or interpret any term, covenant or condition of this Agreement, the prevailing party in such proceeding or action shall be entitled to recover from the other party its reasonable attorney's fees and legal expenses.
- g. Precedence of Documents. In the event of any conflict between the body of this Agreement and any Exhibit or attachment hereto, the terms and conditions of the body of this Agreement shall control and take precedence over the terms and conditions expressed within the Exhibit or attachment.
- h. Cumulative Remedies. No remedy or election hereunder shall be deemed exclusive but shall, wherever possible, be cumulative with all other remedies at law or in equity.
- i. Exhibits and Attachments. Each Exhibit and Attachment referenced herein is by such reference incorporated into and made a part of this Agreement for all purposes.
- j. Extent of Agreement. Each party acknowledges that they have read and fully understand the contents of this Agreement. This Agreement represents the entire and integrated agreement between the parties with respect to the subject matter hereof and supersedes all prior negotiations, representations or agreements, either written or oral. This Agreement may be modified only by written instrument executed by duly authorized representatives of both the City and the County.

9. Time is of the essence of each and every term, condition, and covenant hereof.

10. The County consents to the entry onto County's remaining land adjacent to the work area by City or any contractor of City, for purposes relating to the City's reconstruction work described in Paragraph 3 herein above.

11. It is understood and agreed that as a condition precedent hereto, this Agreement shall have no force and effect until approved by the Fresno County Board of Supervisors and Council for the City of Fresno. This Agreement shall first be executed by County and upon duly authorized execution by the City, this Agreement shall then become a contract for the

purchase and sale of Subject Property, binding upon County and City, their heirs, executors, administrators, successors in interest, and assigns.

Signature Page

This Agreement is executed by the City of Fresno by and through its Public Works Director or his designee, pursuant to authority granted by the Council of the City of Fresno on

COUNTY OF FRESNO

BY: _____
Ernest Buddy Mendes, Chairman
Board of Supervisors

Date _____

REVIEWED AND RECOMMENDED
FOR APPROVAL

BY: _____
STEVEN E. WHITE, Director
Department of Public Works and Planning

ATTEST:
Bernice E. Seidel, Clerk
Board of Supervisors

BY: _____
Deputy

APPROVED AS TO LEGAL FORM
Daniel C. Cederborg, County Counsel

BY: _____
Deputy

APPROVED AS TO ACCOUNTING FORM
Oscar J. Garcia C.P.A., Auditor-Controller/
Treasurer-Tax Collector

BY: _____
Deputy

FOR ACCOUNTING USE ONLY

Fund: 0001
Subclass: 10000
Org. No.: 7910
Account: 5039

CITY OF FRESNO

RECOMMENDED FOR APPROVAL

BY: _____
J. A. "Pete" Caldwell
Senior Real Estate Agent

APPROVED AS TO FORM
Douglas T. Sloan
City Attorney

BY: _____
Deputy City Attorney

FOR APPROVAL

BY: _____
Andrew J. Benelli, Assistant Director
Public Works Department

ATTEST:
Yvonne Spence, CMC
City Clerk

BY: _____
Deputy City Clerk

Recording Requested By:
Public Works Department
City of Fresno
No Fee-Government Code Sections
G6103 and 27383

Exhibit "1"

When Recorded, Mail To:
Public Works Department
City of Fresno
2600 Fresno Street, Room 4019
Fresno, CA 93721-3623
Attention: Right-of-way Section

SPACE ABOVE THIS LINE FOR RECORDER'S USE

APN 466-160-01T (portions)

DEED OF EASEMENT

The County of Fresno, a political subdivision of the State of California, GRANTOR, hereby GRANTS to the City of Fresno, a municipal corporation, GRANTEE, the following parcels situated in the City of Fresno, County of Fresno, State of California:

- 1) Easements and right-of-way for pedestrian walkway purposes and for the purposes of public bus stop facilities and appurtenances thereto, including but not limited to underground utility lines appurtenant to said facilities, over, under, through and across all that real property, designated as Parcels 1 through 4 and more particularly described in Exhibit "A" and shown on Exhibit "B" which are attached and incorporated herein.
- 2) An easement and right-of-way for public utility purposes appurtenant to said bus stop facilities, over, under, through, and across that Real Property, designated as Parcel 5 and 6, more particularly described in Exhibit "C" and shown on Exhibit "D" which are attached and incorporated herein.
- 3) Easements and rights-of-way for public landscape irrigation purposes over, under, through and across that certain Real Property designated as Parcels 7 and 8, more particularly described in Exhibit "E" and shown on Exhibit "F" which are attached and incorporated herein.

TOGETHER WITH the right to enter upon said Real Property and to use equipment and materials thereon by said City, its agents and employees, whenever necessary for the purpose of maintaining or replacing landscaping and appurtenances thereto.

The County of Fresno, a political subdivision of the State of California

By: _____
Ernest Buddy Mendes, Chairman
Board of Supervisors

Dated: _____

By: _____

Dated: _____

EXHIBIT "A"

Page 1 of 4

APN 466-160-01T (portion)

Bus stop easement

PARCEL 1

A portion of that certain Court House Block as shown on the map of the Town (now City) of Fresno recorded in Volume 1 of Plats at Page 2, Fresno County Records, more particularly described as follows:

COMMENCING at the westerly corner of said block; thence S 40°59'03" E, along the southwesterly line of said block, a distance of 35.00 feet to a line parallel with and 35.00 feet southeasterly of the northwesterly line of said block; thence N 48°59'57" E, along said parallel line, a distance of 31.00 feet to the northeasterly right-of-way line of that portion of Van Ness Avenue previously dedicated for public street purposes by that Grant of Easement recorded June 22, 1953, as Document No. 35387 in Book 3321 at Page 666, Official Records of Fresno County; thence N 48°59'57" E, along the southeasterly right-of-way line of that portion of Fresno Street previously dedicated for public street purposes by that Grant of Easement recorded September 11, 1952, as Document No. 46385 in Book 3208 at Page 376, Official Records of Fresno County, parallel with and 35.00 feet southeasterly of the northwesterly line of said block, a distance of 151.54 feet to the TRUE POINT OF BEGINNING of this description; thence continuing N 48°59'57" E, along said southeasterly right-of-way line, a distance of 6.41 feet to the southwesterly line of a parcel designated as Parcel 2 and described in an unrecorded agreement dated June 20, 1989, between the City of Fresno and the County of Fresno to install and maintain a bus stop facility; thence along said southwesterly line, S 41°02'32" E, a distance of 24.00 feet; thence S 48°59'57" W, parallel with and 59.00 feet southeasterly of the northwesterly line of said block, a distance of 6.41 feet; thence N 41°02'32" W, parallel to said southwesterly line, a distance of 24.00 feet to the TRUE POINT OF BEGINNING.

Contains an area of 154 square feet, more or less.

EXHIBIT "A"

Page 2 of 4

APN 466-160-01T (portion)
Bus stop easement

PARCEL 2

A portion of that certain Court House Block as shown on the map of the Town (now City) of Fresno recorded in Volume 1 of Plats at Page 2, Fresno County Records, more particularly described as follows:

COMMENCING at the westerly corner of said block; thence S 40°59'03" E, along the southwesterly line of said block, a distance of 35.00 feet to a line parallel with and 35.00 feet southeasterly of the northwesterly line of said block; thence N 48°59'57" E, along said parallel line, a distance of 31.00 feet to the northeasterly right-of-way line of that portion of Van Ness Avenue previously dedicated for public street purposes by that Grant of Easement recorded June 22, 1953, as Document No. 35387 in Book 3321 at Page 666, Official Records of Fresno County; thence N 48°59'57" E, along the southeasterly right-of-way line of that portion of Fresno Street previously dedicated for public street purposes by that Grant of Easement recorded September 11, 1952, as Document No. 46385 in Book 3208 at Page 376, Official Records of Fresno County, parallel with and 35.00 feet southeasterly of the northwesterly line of said block, a distance of 297.45 feet to the north corner of a parcel designated as Parcel 2 and described in an unrecorded agreement dated June 20, 1989, between the City of Fresno and the County of Fresno to install and maintain a bus stop facility, said north corner being the TRUE POINT OF BEGINNING of this description; thence S 41°02'32" E, along the northeasterly line of said Parcel 2, a distance of 20.10 feet; thence N 48°59'57" E, parallel with the northwesterly line of said block, a distance of 14.55 feet; thence N 41°02'32" W, parallel with last said northeasterly line, a distance of 11.20 feet; thence N 48°59'57" E, parallel with the northwesterly line of said block, a distance of 19.29 feet to a point of cusp of a tangent curve concave northeasterly and having a radius of 4.05 feet; thence northwesterly and northerly, along the arc of said curve, through a central angle of 157°00'10", an arc distance of 11.09 feet; thence N 63°59'52" W, non-tangent to last said curve, a distance of 1.22 feet to said southeasterly right-of-way line of Fresno Street; thence S 49°01'51" W, along said southeasterly right-of-way line of Fresno Street, parallel with and 35.00 feet southeasterly of the northwesterly line of said block, a distance of 0.78 feet to an angle point in said southeasterly right-of-way line; thence S 48°59'57" W, along said southeasterly right-of-way line, parallel with and 35.00 feet southeasterly of the northwesterly line of said block, a distance of 31.01 feet to the TRUE POINT OF BEGINNING.

Contains an area of 436 square feet, more or less.

EXHIBIT "A"

Page 3 of 4

APN 466-160-01T (portion)
Bus stop easement

PARCEL 3

A portion of that certain Court House Block as shown on the map of the Town (now City) of Fresno recorded in Volume 1 of Plats at Page 2, Fresno County Records, more particularly described as follows:

COMMENCING at the westerly corner of said block; thence N 48°59'57" E, along the northwesterly line of said block, a distance of 31.00 feet to a line parallel with and 31.00 feet northeasterly of the southwesterly line of said block; thence S 40°59'03" E, along said parallel line, a distance of 35.00 feet to the southeasterly right-of-way line of that portion of Fresno Street previously dedicated for public street purposes by that Grant of Easement recorded September 11, 1952, as Document No. 46385 in Book 3208 at Page 376, Official Records of Fresno County; thence S 40°59'03" E, along the northeasterly right-of-way line of that portion of Van Ness Avenue previously dedicated for public street purposes by that Grant of Easement recorded June 22, 1953, as Document No. 35387 in Book 3321 at Page 666, Official Records of Fresno County, parallel with and 31.00 feet northeasterly of the southwesterly line of said block, a distance of 175.01 feet to the TRUE POINT OF BEGINNING of this description; thence leaving said northeasterly right-of-way line, N 49°00'57" E, a distance of 2.77 feet; thence N 18°41'47" E, a distance of 8.97 feet; thence N 34°55'32" W, a distance of 2.27 feet; thence N 48°05'15" E, a distance of 11.72 feet; thence S 40°59'03" E, parallel with and 53.47 feet northeasterly of the southwesterly line of said block, a distance of 198.22 feet to a point on the northwesterly boundary of that previously dedicated easement for entrance to and exit from a public underpass designated and described as Parcel "A" in that Grant of Easements recorded August 18, 1965, as Document No. 66668 in Book 5206 at Page 300, Official Records of Fresno County, said point being the beginning of a non-tangent curve concave southerly and having a radius of 16.00 feet, a radial to said beginning bears N 0°06'37" W; thence westerly, along said northwesterly boundary and along the arc of said non-tangent curve, through a central angle of 40°52'26", an arc distance of 11.41 feet; thence N 40°59'03" W, continuing along said northwesterly boundary, parallel with and 43.00 feet northeasterly of the southwesterly line of said block and non-tangent to last said curve, a distance of 15.00 feet to the beginning of a tangent curve concave southerly and having a radius of 18.00 feet; thence westerly, continuing along said northwesterly boundary and along the arc of said curve, through a central angle of 70°31'44", an arc distance of 22.16 feet to said northeasterly right-of-way line; thence N 40°59'03" W, along said northeasterly right-of-way line, parallel with and 31.00 feet northeasterly of the southwesterly line of said block and non-tangent to last said curve, a distance of 155.37 feet to the TRUE POINT OF BEGINNING.

Contains an area of 3,994 square feet, more or less.

EXHIBIT "A"

Page 4 of 4

APN 466-160-01T (portion)
Bus stop easement

PARCEL 4

A portion of that certain Court House Block as shown on the map of the Town (now City) of Fresno recorded in Volume 1 of Plats at Page 2, Fresno County Records, more particularly described as follows:

COMMENCING at the westerly corner of said block; thence N 48°59'57" E, along the northwesterly line of said block, a distance of 31.00 feet to a line parallel with and 31.00 feet northeasterly of the southwesterly line of said block; thence S 40°59'03" E, along said parallel line, a distance of 35.00 feet to the southeasterly right-of-way line of that portion of Fresno Street previously dedicated for public street purposes by that Grant of Easement recorded September 11, 1952, as Document No. 46385 in Book 3208 at Page 376, Official Records of Fresno County; thence S 40°59'03" E, along the northeasterly right-of-way line of that portion of Van Ness Avenue previously dedicated for public street purposes by that Grant of Easement recorded June 22, 1953, as Document No. 35387 in Book 3321 at Page 666, Official Records of Fresno County, parallel with and 31.00 feet northeasterly of the southwesterly line of said block, a distance of 480.32 feet to the TRUE POINT OF BEGINNING of this description; thence S 40°59'03" E, continuing along said northeasterly right-of-way line, a distance of 154.97 feet; thence leaving said northeasterly right-of-way line, N 49°00'57" E, a distance of 2.50 feet; thence N 78°55'00" E, a distance of 9.40 feet; thence S 40°59'03" E, parallel with the southwesterly line of said block, a distance of 2.80 feet; thence N 49°00'57" E, a distance of 11.96 feet; thence N 40°59'03" W, parallel with and 53.61 feet northeasterly of the southwesterly line of said block, a distance of 198.45 feet to a point on the southeasterly boundary of that previously dedicated easement for entrance to and exit from a public underpass designated and described as Parcel "A" in that Grant of Easements recorded August 18, 1965, as Document No. 66668 in Book 5206 at Page 300, Official Records of Fresno County, said point being the beginning of a non-tangent curve concave northwesterly and having a radius of 16.00 feet, a radial to said beginning bears S 82°31'02" E; thence southwesterly, along said southeasterly boundary and along the arc of said curve, through a central angle of 41°31'59", an arc distance of 11.60 feet; thence S 40°59'03" E, continuing along said southeasterly boundary, non-tangent to last said curve, a distance of 15.00 feet to the beginning of a tangent curve concave westerly and having a radius of 18.00 feet; thence southerly, continuing along said southeasterly boundary and along the arc of said curve, through a central angle of 70°31'44", an arc distance of 22.16 feet to the TRUE POINT OF BEGINNING.

Contains an area of 4,020 square feet, more or less.

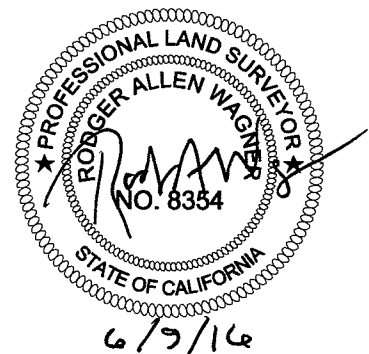

EXHIBIT "B"

SHEET 1 OF 4

LINE TABLE
BEARING LENGTH

LI	BEARING	LENGTH
L1	S 40°59'03" E	35.00'
L2	N 48°59'57" E	31.00'

WESTERLY CORNER OF COURT HOUSE BLOCK
POINT OF COMMENCEMENT
FOR ALL PARCELS



- ① = PREVIOUSLY DEDICATED FOR PUBLIC STREET PURPOSES BY GRANT OF EASEMENT RECORDED 9/11/1952 AS DOCUMENT NO. 46385 IN BOOK 3208 AT PAGE 376, O.R.F.C.
- ② = PREVIOUSLY DEDICATED FOR PUBLIC STREET PURPOSES BY GRANT OF EASEMENT RECORDED 6/22/1953 AS DOCUMENT NO. 35387 IN BOOK 3321 AT PAGE 666, O.R.F.C.
- ③ = PREVIOUSLY DEDICATED FOR THE PURPOSE OF AN ENTRANCE TO AND EXIT FROM A PUBLIC UNDERPASS BY GRANT OF EASEMENTS (PARCEL "A") RECORDED 8/18/1965 AS DOCUMENT NO. 66668 IN BOOK 5206 AT PAGE 300, O.R.F.C.
- ④ = PUBLIC STREET VACATED BY CITY OF FRESNO RESOLUTION NO. 8576 RECORDED 8/12/1965 AS DOCUMENT NO. 69677 IN BOOK 5210 AT PAGE 614, O.R.F.C.
- ⑤ = UNRECORDED AGREEMENT DATED 6/20/1989 BETWEEN THE CITY AND COUNTY OF FRESNO TO RECONSTRUCT, MODIFY, EXPAND AND MAINTAIN A BUS STOP FACILITY (PARCELS 1 & 2)

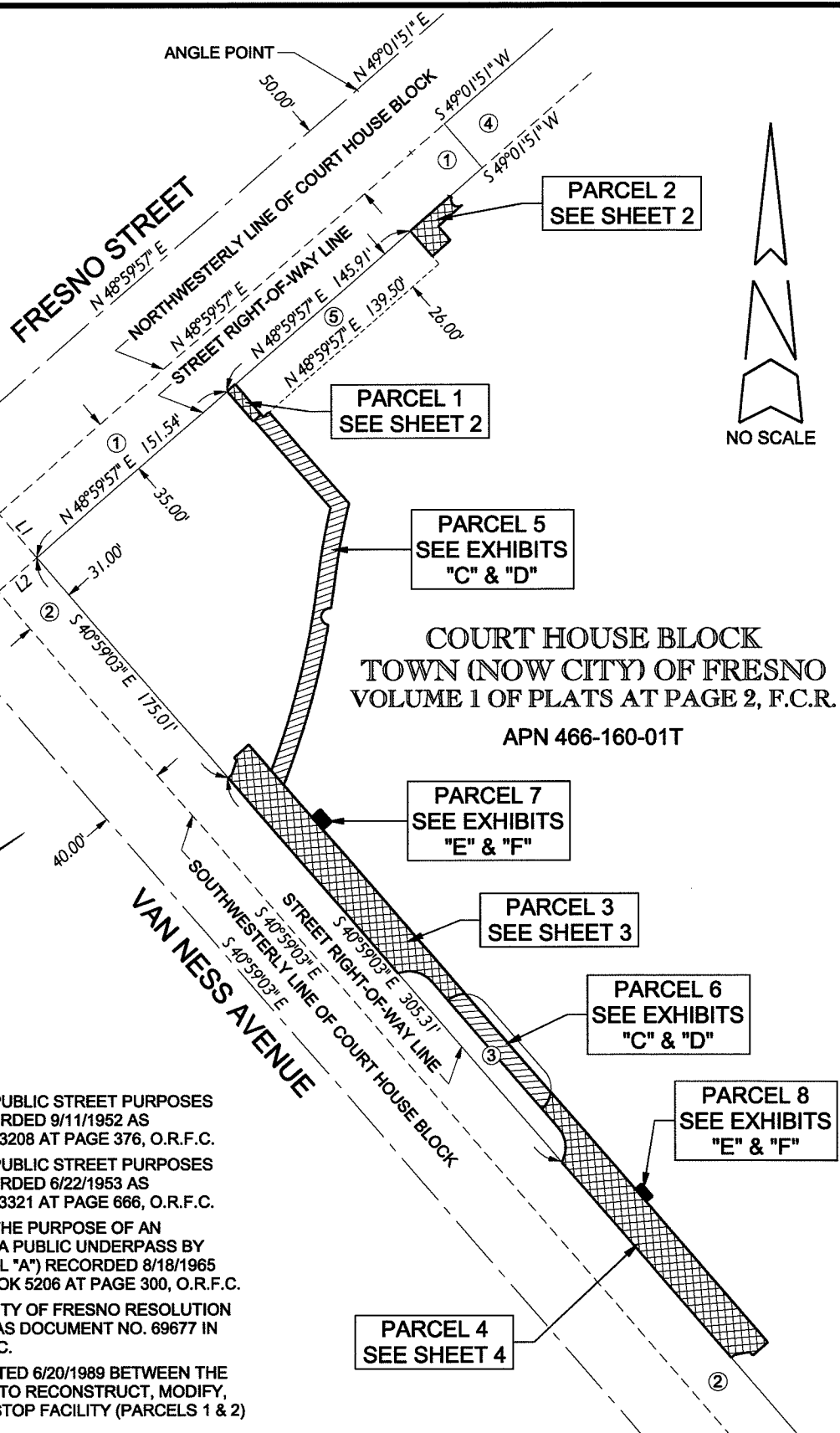

COURT HOUSE BLOCK
TOWN (NOW CITY) OF FRESNO
VOLUME 1 OF PLATS AT PAGE 2, F.C.R.
APN 466-160-01T

REF. & REV. 2016-047 PLATS 2656 & 2756	CITY OF FRESNO DEPARTMENT OF PUBLIC WORKS	PROJ. ID. FC00049	PCBU	FAX
		FUND NO. 43532	ACT. ID	PLANNING
PARCELS TO BE DEDICATED TO THE CITY OF FRESNO FOR BUS STOP PURPOSES		DR. BY AJ	SHEET NO. 1	
		CH. BY R.A.W.	OF 8 SHEETS	
		DATE MAY 31, 2016	15-A-9260	
		SCALE NO SCALE		

EXHIBIT "B"

SHEET 2 OF 4

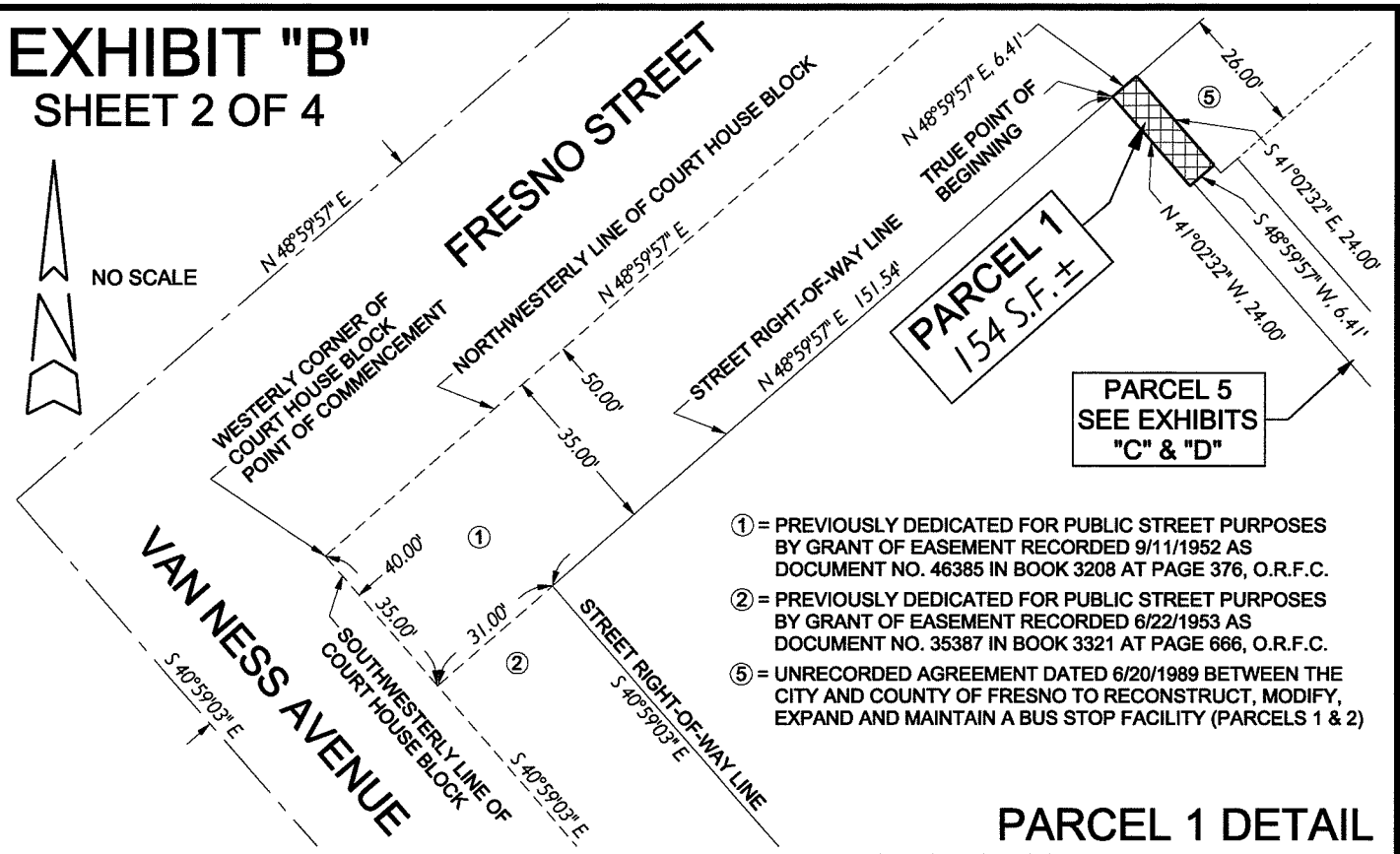

- ① = PREVIOUSLY DEDICATED FOR PUBLIC STREET PURPOSES BY GRANT OF EASEMENT RECORDED 9/11/1952 AS DOCUMENT NO. 46385 IN BOOK 3208 AT PAGE 376, O.R.F.C.
- ② = PREVIOUSLY DEDICATED FOR PUBLIC STREET PURPOSES BY GRANT OF EASEMENT RECORDED 6/22/1953 AS DOCUMENT NO. 35387 IN BOOK 3321 AT PAGE 666, O.R.F.C.
- ⑤ = UNRECORDED AGREEMENT DATED 6/20/1989 BETWEEN THE CITY AND COUNTY OF FRESNO TO RECONSTRUCT, MODIFY, EXPAND AND MAINTAIN A BUS STOP FACILITY (PARCELS 1 & 2)

PARCEL 1 DETAIL

PARCEL 2 DETAIL

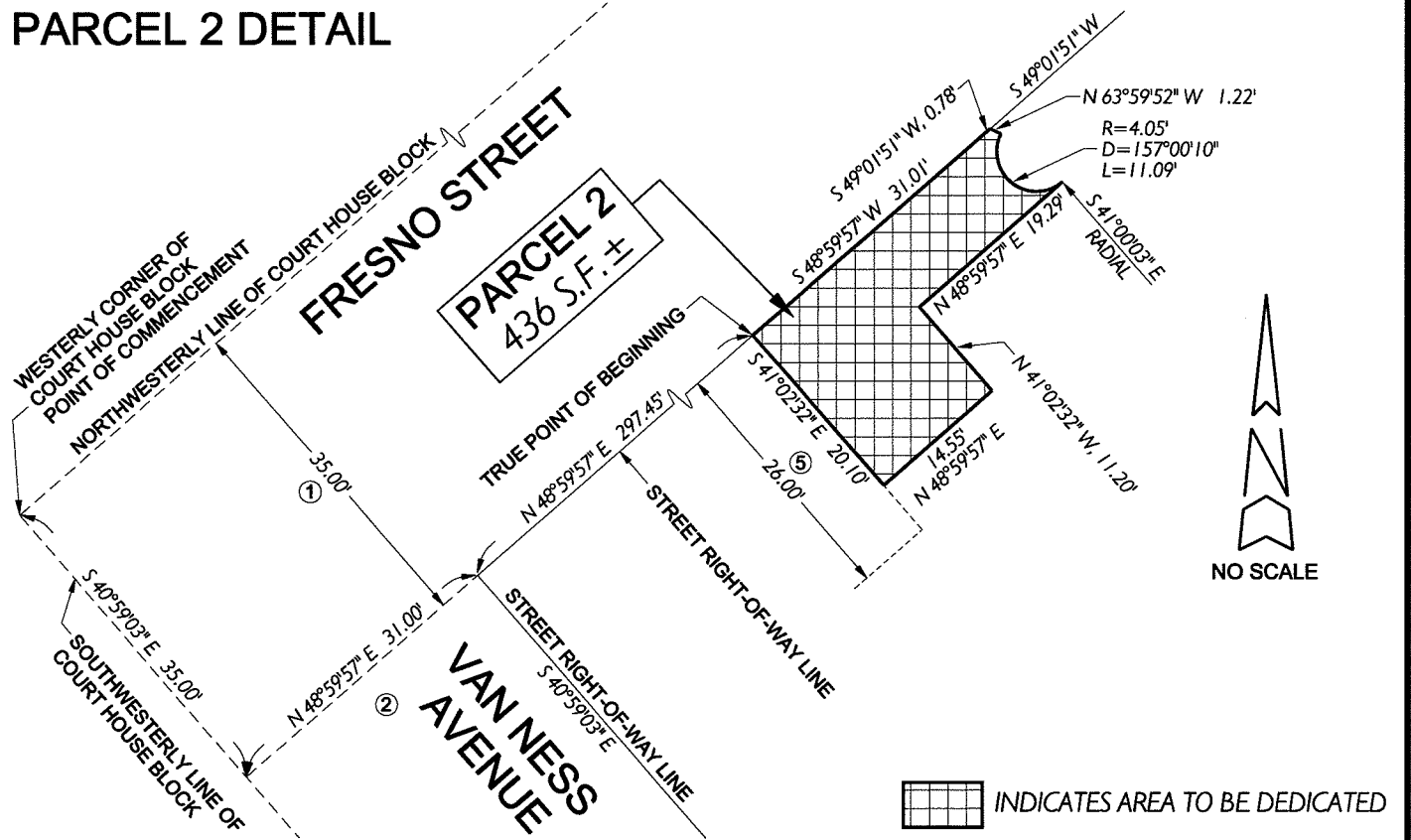

INDICATES AREA TO BE DEDICATED

REF. & REV.
2016-047
PLATS 2656 & 2756

CITY OF FRESNO
DEPARTMENT OF PUBLIC WORKS

**PARCELS TO BE DEDICATED TO
THE CITY OF FRESNO
FOR BUS STOP PURPOSES**

PROJ. ID. FC00049	PCBU	FAX
FUND NO. 43532	ACT. ID	PLANNING
ORG. NO. 459901		
DR. BY AJ	SHEET NO. 2	
CH. BY R.A.W.	OF 8 SHEETS	
DATE MAY 25, 2016	15-A-9260	
SCALE NO SCALE		

EXHIBIT "B"

SHEET 3 OF 4

COURT HOUSE BLOCK
 TOWN (NOW CITY) OF FRESNO
 VOLUME 1 OF PLATS AT PAGE 2, F.C.R.
 APN 466-160-01T

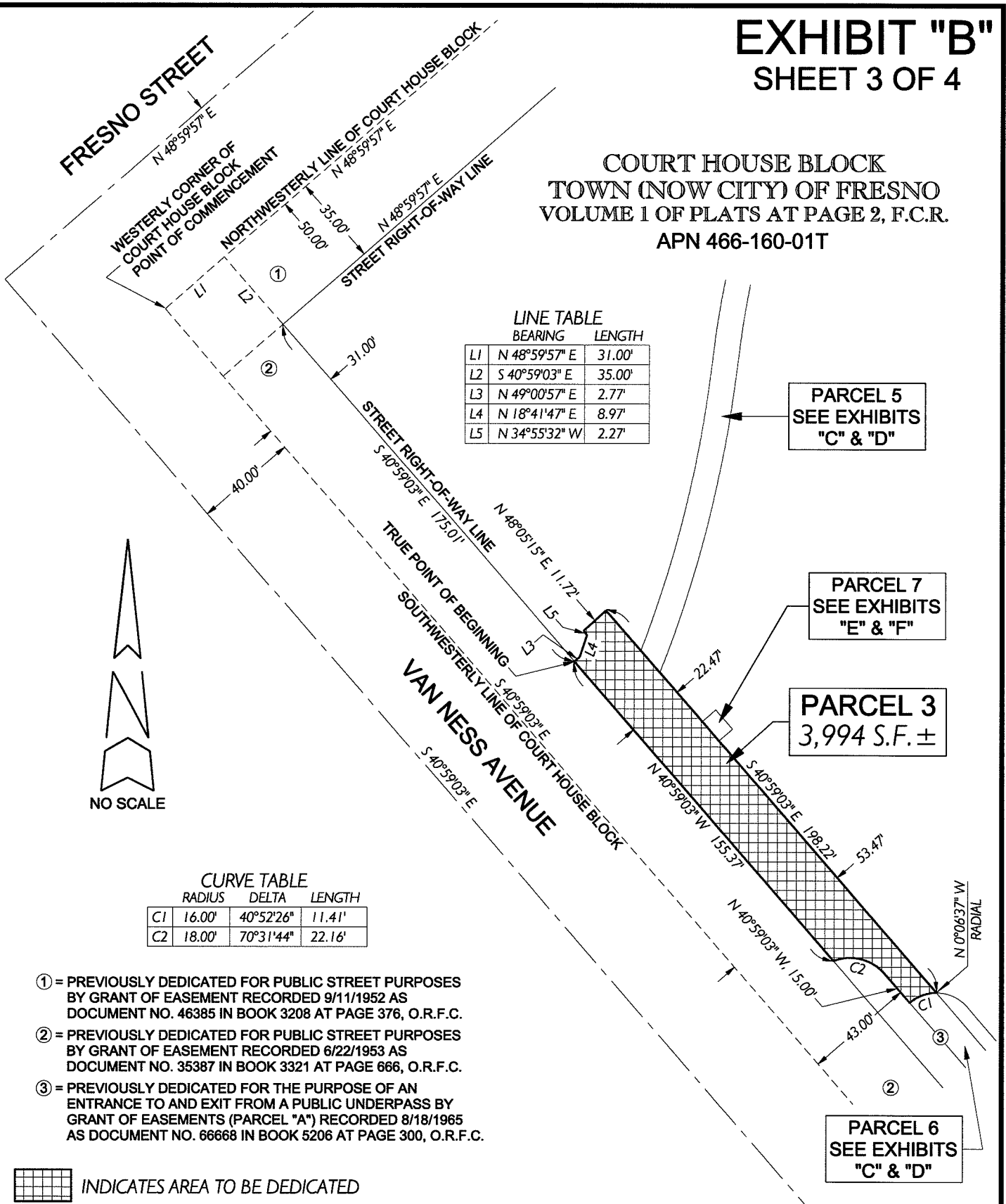

LINE TABLE

	BEARING	LENGTH
L1	$N 48^{\circ}59'57'' E$	31.00'
L2	$S 40^{\circ}59'03'' E$	35.00'
L3	$N 49^{\circ}00'57'' E$	2.77'
L4	$N 18^{\circ}41'47'' E$	8.97'
L5	$N 34^{\circ}55'32'' W$	2.27'

CURVE TABLE

	RADIUS	DELTA	LENGTH
C1	16.00'	$40^{\circ}52'26''$	11.41'
C2	18.00'	$70^{\circ}31'44''$	22.16'

- ① = PREVIOUSLY DEDICATED FOR PUBLIC STREET PURPOSES BY GRANT OF EASEMENT RECORDED 9/11/1952 AS DOCUMENT NO. 46385 IN BOOK 3208 AT PAGE 376, O.R.F.C.
- ② = PREVIOUSLY DEDICATED FOR PUBLIC STREET PURPOSES BY GRANT OF EASEMENT RECORDED 6/22/1953 AS DOCUMENT NO. 35387 IN BOOK 3321 AT PAGE 666, O.R.F.C.
- ③ = PREVIOUSLY DEDICATED FOR THE PURPOSE OF AN ENTRANCE TO AND EXIT FROM A PUBLIC UNDERPASS BY GRANT OF EASEMENTS (PARCEL "A") RECORDED 8/18/1965 AS DOCUMENT NO. 66668 IN BOOK 5206 AT PAGE 300, O.R.F.C.

 INDICATES AREA TO BE DEDICATED

REF. & REV. 2016-047 PLATS 2656 & 2756	CITY OF FRESNO DEPARTMENT OF PUBLIC WORKS PARCELS TO BE DEDICATED TO THE CITY OF FRESNO FOR BUS STOP PURPOSES	PROJ. ID. FC00049 PCBU FAX FUND NO. 43532 ACT. ID PLANNING ORG. NO. 459901	DR. BY AJ CH. BY R.A.W. DATE MAY 26, 2016 SCALE NO SCALE
		SHEET NO. 3 OF 8 SHEETS 15-A-9260	

EXHIBIT "B"

SHEET 4 OF 4

COURT HOUSE BLOCK
 TOWN (NOW CITY) OF FRESNO
 VOLUME 1 OF PLATS AT PAGE 2, F.C.R.
 APN 466-160-01T

LINE TABLE

	BEARING	LENGTH
L1	N 48°59'57" E	31.00'
L2	S 40°59'03" E	35.00'
L3	N 49°00'57" E	2.50'
L4	N 78°55'00" E	9.40'
L5	S 40°59'03" E	2.80'

PARCEL 6
 SEE EXHIBITS
 "C" & "D"

PARCEL 4
 4,020 S.F. ±

PARCEL 8
 SEE EXHIBITS
 "E" & "F"

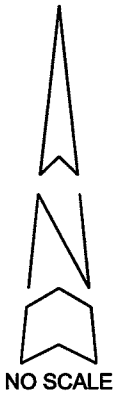

CURVE TABLE

	RADIUS	DELTA	LENGTH
C1	16.00'	41°31'59"	11.60'
C2	18.00'	70°31'44"	22.16'

- ① = PREVIOUSLY DEDICATED FOR PUBLIC STREET PURPOSES BY GRANT OF EASEMENT RECORDED 9/11/1952 AS DOCUMENT NO. 46385 IN BOOK 3208 AT PAGE 376, O.R.F.C.
- ② = PREVIOUSLY DEDICATED FOR PUBLIC STREET PURPOSES BY GRANT OF EASEMENT RECORDED 8/22/1953 AS DOCUMENT NO. 35387 IN BOOK 3321 AT PAGE 666, O.R.F.C.
- ③ = PREVIOUSLY DEDICATED FOR THE PURPOSE OF AN ENTRANCE TO AND EXIT FROM A PUBLIC UNDERPASS BY GRANT OF EASEMENTS (PARCEL "A") RECORDED 8/18/1965 AS DOCUMENT NO. 66668 IN BOOK 5206 AT PAGE 300, O.R.F.C.

INDICATES AREA TO BE DEDICATED

REF. & REV. 2016-047 PLATS 2656 & 2756	CITY OF FRESNO DEPARTMENT OF PUBLIC WORKS PARCELS TO BE DEDICATED TO THE CITY OF FRESNO FOR BUS STOP PURPOSES	PROJ. ID. FC00049 PCBU FAX FUND NO. 43532 ACT. ID. PLANNING ORG. NO. 459901	DR. BY. AJ CH. BY. R.A.W. DATE. MAY 26, 2016 SCALE. NO SCALE
		SHEET NO. 4 OF 8 SHEETS 15-A-9260	

EXHIBIT "C"

Page 1 of 2

APN 466-160-01T (portion)
Public utility easement

PARCEL 5

A portion of that certain Court House Block as shown on the map of the Town (now City) of Fresno recorded in Volume 1 of Plats at Page 2, Fresno County Records, more particularly described as follows:

COMMENCING at the westerly corner of said block; thence S 40°59'03" E, along the southwesterly line of said block, a distance of 35.00 feet to a line parallel with and 35.00 feet southeasterly of the northwesterly line of said block; thence N 48°59'57" E, along said parallel line, a distance of 31.00 feet to the northeasterly right-of-way line of that portion of Van Ness Avenue previously dedicated for public street purposes by that Grant of Easement recorded June 22, 1953, as Document No. 35387 in Book 3321 at Page 666, Official Records of Fresno County; thence N 48°59'57" E, along the southeasterly right-of-way line of that portion of Fresno Street previously dedicated for public street purposes by that Grant of Easement recorded September 11, 1952, as Document No. 46385 in Book 3208 at Page 376, Official Records of Fresno County, parallel with and 35.00 feet southeasterly of the northwesterly line of said block, a distance of 151.54 feet; thence S 41°02'32" E, a distance of 24.00 feet; thence N 48°59'57" E, parallel with and 59.00 feet southeasterly of the northwesterly line of said block, a distance of 0.87 feet to the TRUE POINT OF BEGINNING of this description; thence continuing N 48°59'57" E, parallel with and 59.00 feet southeasterly of the northwesterly line of said block, a distance of 5.54 feet to the southwesterly line of a parcel designated as Parcel 2 and described in an unrecorded agreement dated June 20, 1989, between the City of Fresno and the County of Fresno to install and maintain a bus stop facility; thence S 41°02'32" E, along said southwesterly line, a distance of 2.00 feet to the southerly corner of said Parcel 2; thence N 48°59'57" E, along the southeasterly line of said Parcel 2, parallel with and 61.00 feet southeasterly of the northwesterly line of said block, a distance of 4.46 feet; thence S 41°02'31" E, a distance of 72.61 feet to the beginning of a non-tangent curve concave easterly and having a radius of 375.00 feet, a radial to said beginning bears N 76°01'48" W; thence southerly, along the arc of said non-tangent curve, through a central angle of 6°23'43", an arc distance of 41.86 feet; thence S 7°34'29" W, a distance of 13.94 feet to the beginning of a tangent curve concave westerly and having a radius of 485.00 feet; thence southerly, along the arc of said curve, through a central angle of 0°56'51", an arc distance of 8.02 feet to the beginning of a non-tangent curve concave easterly and having a radius of 5.00 feet, a radial to said beginning bears N 8°49'03" E; thence westerly, southerly and easterly, along the arc of said curve, through a central angle of 179°24'34", an arc distance of 15.66 feet to the beginning of a non-tangent curve concave westerly and having a radius of 485.00 feet, a radial to said beginning bears S 80°17'47" E; thence southerly, along the arc of said curve, through a central angle of 11°46'16", an arc distance of 99.64 feet to a line parallel with and 53.47 feet northeasterly of the southwesterly line of said block; thence N 40°59'03" W, along said parallel line and non-tangent to last said curve, a distance of 11.31 feet to the beginning of a non-tangent curve concave westerly and having a radius of 475.00 feet, a radial to said beginning bears S 69°09'22" E; thence northerly, along the arc of last said non-tangent curve, through a central angle of 13°16'09", an arc distance of 110.00 feet; thence N 7°34'29" E, a distance of 13.94 feet to the beginning of a tangent curve concave easterly and having a radius of 385.00 feet; thence northerly, along the arc of last said curve, through a central angle of 5°37'00", an arc distance of 37.74 feet; thence N 41°02'31" W, non-tangent to last said curve, a distance of 69.46 feet to the TRUE POINT OF BEGINNING.

Contains an area of 2,348 square feet, more or less.

EXHIBIT "C"

Page 2 of 2

APN 466-160-01T (portion)

Public utility easement

PARCEL 6

A portion of that certain previously dedicated easement for entrance to and exit from a public underpass designated and described as Parcel "A" in that Grant of Easements recorded August 18, 1965, as Document No. 66668 in Book 5206 at Page 300, Official Records of Fresno County, said Parcel "A" being a portion of Court House Block as shown on the map of the Town (now City) of Fresno recorded in Volume 1 of Plats at Page 2, Fresno County Records, more particularly described as follows:

COMMENCING at the westerly corner of said block; thence N 48°59'57" E, along the northwesterly line of said block, a distance of 31.00 feet to a line parallel with and 31.00 feet northeasterly of the southwesterly line of said block; thence S 40°59'03" E, along said parallel line, a distance of 35.00 feet to the southeasterly right-of-way line of that portion of Fresno Street previously dedicated for public street purposes by that Grant of Easement recorded September 11, 1952, as Document No. 46385 in Book 3208 at Page 376, Official Records of Fresno County; thence S 40°59'03" E, along the northeasterly right-of-way line of that portion of Van Ness Avenue previously dedicated for public street purposes by that Grant of Easement recorded June 22, 1953, as Document No. 35387 in Book 3321 at Page 666, Official Records of Fresno County, parallel with and 31.00 feet northeasterly of the southwesterly line of said block, a distance of 330.38 feet; thence N 49°00'57" E, a distance of 12.00 feet to a point on the northwesterly boundary of said Parcel "A", said point being the beginning of a tangent curve concave southerly and having a radius of 16.00 feet, said point also being the TRUE POINT OF BEGINNING of this description; thence easterly, along said northwesterly boundary and along the arc of said curve, through a central angle of 40°52'26", an arc distance of 11.41 feet; thence leaving said northwesterly boundary S 40°59'03" E, parallel with and 53.47 feet northeasterly of the southwesterly line of said block, non-tangent to last said curve, a distance of 78.20 feet to a point on the southeasterly boundary of said Parcel "A", said point being the beginning of a non-tangent curve concave northwesterly and having a radius of 16.00 feet, a radial to said beginning bears S 81°51'29" E; thence southwesterly, along said southeasterly boundary and along the arc of said curve, through a central angle of 40°52'26", an arc distance of 11.41 feet; thence N 40°59'03" W, parallel with and 43.00 feet northeasterly of the southwesterly line of said block and non-tangent to last said curve, a distance of 86.00 feet to the TRUE POINT OF BEGINNING.

Contains an area of 875 square feet, more or less.

2016-047
15-A-9260

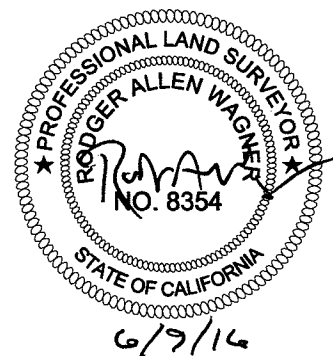
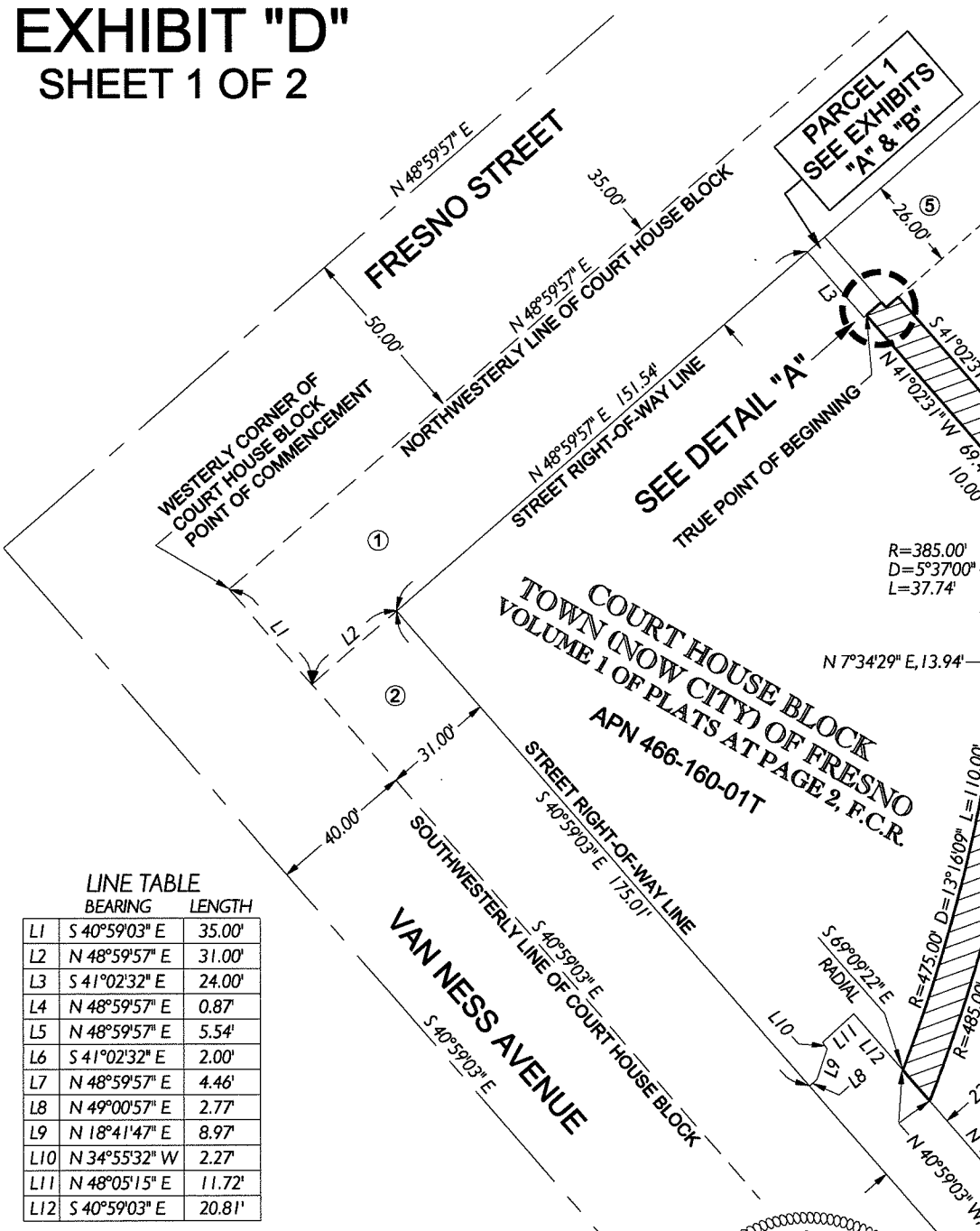
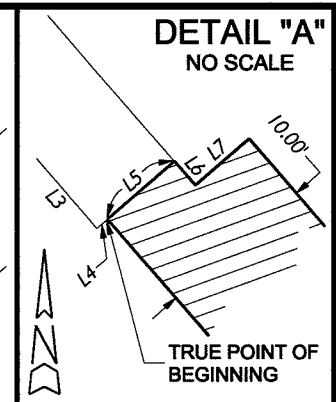

EXHIBIT "D"

SHEET 1 OF 2



PARCEL 5
2,348 S.F. ±

PARCEL 3
SEE EXHIBITS "A" & "B"

LINE TABLE
BEARING LENGTH

LINE	BEARING	LENGTH
L1	S 40°59'03" E	35.00'
L2	N 48°59'57" E	31.00'
L3	S 41°02'32" E	24.00'
L4	N 48°59'57" E	0.87'
L5	N 48°59'57" E	5.54'
L6	S 41°02'32" E	2.00'
L7	N 48°59'57" E	4.46'
L8	N 49°00'57" E	2.77'
L9	N 18°41'47" E	8.97'
L10	N 34°55'32" W	2.27'
L11	N 48°05'15" E	11.72'
L12	S 40°59'03" E	20.81'

- ① = PREVIOUSLY DEDICATED FOR PUBLIC STREET PURPOSES BY GRANT OF EASEMENT RECORDED 9/11/1952 AS DOCUMENT NO. 46385 IN BOOK 3208 AT PAGE 376, O.R.F.C.
- ② = PREVIOUSLY DEDICATED FOR PUBLIC STREET PURPOSES BY GRANT OF EASEMENT RECORDED 6/22/1953 AS DOCUMENT NO. 35387 IN BOOK 3321 AT PAGE 666, O.R.F.C.
- ⑤ = UNRECORDED AGREEMENT DATED 6/20/1989 BETWEEN THE CITY AND COUNTY OF FRESNO TO RECONSTRUCT, MODIFY, EXPAND AND MAINTAIN A BUS STOP FACILITY (PARCELS 1 & 2)

INDICATES AREA TO BE DEDICATED

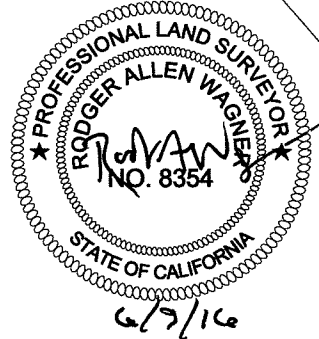

CURVE TABLE

	RADIUS	DELTA	LENGTH
C1	485.00'	0°56'51"	8.02'
C2	5.00'	179°24'34"	15.66'

REF. & REV.
2016-047
PLATS 2656 & 2756

CITY OF FRESNO
DEPARTMENT OF PUBLIC WORKS

**PARCELS TO BE DEDICATED TO
THE CITY OF FRESNO
FOR BUS STOP UTILITY PURPOSES**

PROJ. ID.	FC00049	PCBU	FAX
FUND NO.	43532	ACT. ID	PLANNING
ORG. NO.	459901		
DR. BY	AJ	SHEET NO.	5
CH. BY	RA.W.	OF	8 SHEETS
DATE	MAY 31, 2016	15-A-9260	
SCALE	NO SCALE		

EXHIBIT "D"

SHEET 2 OF 2

COURT HOUSE BLOCK
 TOWN (NOW CITY) OF FRESNO
 VOLUME 1 OF PLATS AT PAGE 2, F.C.R.
 APN 466-160-01T

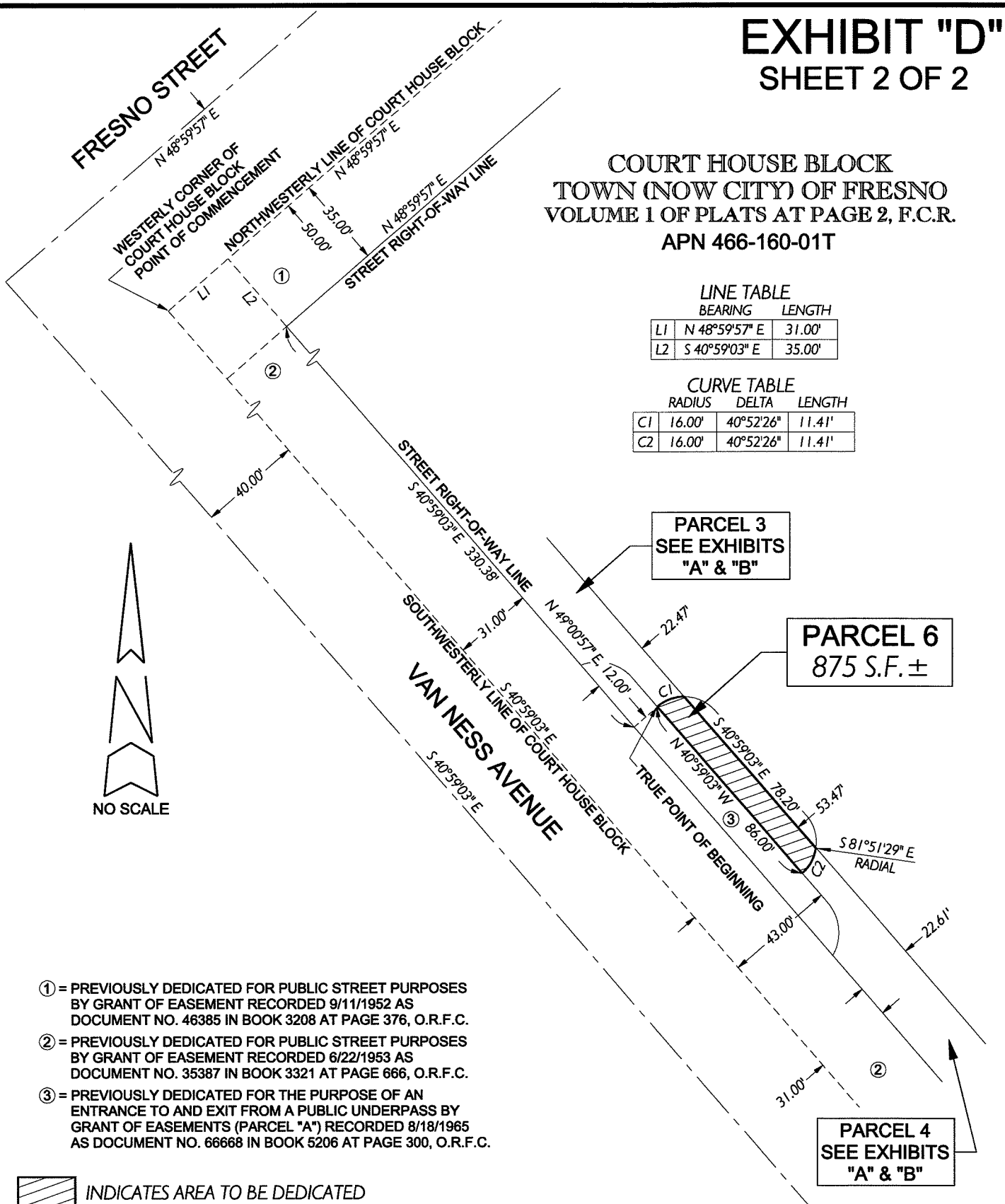

LINE TABLE

	BEARING	LENGTH
L1	N 48°59'57" E	31.00'
L2	S 40°59'03" E	35.00'

CURVE TABLE

	RADIUS	DELTA	LENGTH
C1	16.00'	40°52'26"	11.41'
C2	16.00'	40°52'26"	11.41'

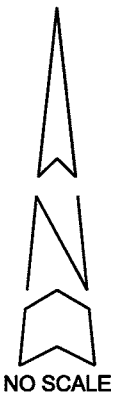

PARCEL 3
 SEE EXHIBITS
 "A" & "B"

PARCEL 6
 875 S.F. ±

PARCEL 4
 SEE EXHIBITS
 "A" & "B"

- ① = PREVIOUSLY DEDICATED FOR PUBLIC STREET PURPOSES BY GRANT OF EASEMENT RECORDED 9/11/1952 AS DOCUMENT NO. 46385 IN BOOK 3208 AT PAGE 376, O.R.F.C.
- ② = PREVIOUSLY DEDICATED FOR PUBLIC STREET PURPOSES BY GRANT OF EASEMENT RECORDED 6/22/1953 AS DOCUMENT NO. 35387 IN BOOK 3321 AT PAGE 666, O.R.F.C.
- ③ = PREVIOUSLY DEDICATED FOR THE PURPOSE OF AN ENTRANCE TO AND EXIT FROM A PUBLIC UNDERPASS BY GRANT OF EASEMENTS (PARCEL "A") RECORDED 8/18/1965 AS DOCUMENT NO. 66668 IN BOOK 5206 AT PAGE 300, O.R.F.C.

INDICATES AREA TO BE DEDICATED

REF. & REV. 2016-047 PLATS 2656 & 2756	CITY OF FRESNO DEPARTMENT OF PUBLIC WORKS	PROJ. ID. FC00049 PCBU FAX FUND NO. 43532 ACT. ID. PLANNING ORG. NO. 459901	DR. BY A.J. CH. BY R.A.W. DATE MAY 31, 2016 SCALE NO SCALE
PARCELS TO BE DEDICATED TO THE CITY OF FRESNO FOR BUS STOP UTILITY PURPOSES		SHEET NO. 6 OF 8 SHEETS 15-A-9260	

EXHIBIT "E"

Page 1 of 2

APN 466-160-01T (portion)
Public landscape irrigation easement

PARCEL 7

A portion of that certain Court House Block as shown on the map of the Town (now City) of Fresno recorded in Volume 1 of Plats at Page 2, Fresno County Records, more particularly described as follows:

COMMENCING at the westerly corner of said block; thence N 48°59'57" E, along the northwesterly line of said block, a distance of 31.00 feet to a line parallel with and 31.00 feet northeasterly of the southwesterly line of said block; thence S 40°59'03" E, along said parallel line, a distance of 35.00 feet to the southeasterly right-of-way line of that portion of Fresno Street previously dedicated for public street purposes by that Grant of Easement recorded September 11, 1952, as Document No. 46385 in Book 3208 at Page 376, Official Records of Fresno County; thence S 40°59'03" E, along the northeasterly right-of-way line of that portion of Van Ness Avenue previously dedicated for public street purposes by that Grant of Easement recorded June 22, 1953, as Document No. 35387 in Book 3321 at Page 666, Official Records of Fresno County, parallel with and 31.00 feet northeasterly of the southwesterly line of said block, a distance of 225.61 feet; thence N 49°00'57" E, a distance of 22.47 feet to a point on a line parallel with and 53.47 feet northeasterly of the southwesterly line of said block, said point being the TRUE POINT OF BEGINNING of this description; thence S 40°59'03" E, along last said parallel line, a distance of 10.00 feet; thence N 49°00'57" E, a distance of 7.00 feet; thence N 40°59'03" W, parallel with and 60.47 feet northeasterly of the southwesterly line of said block, a distance of 10.00 feet; thence S 49°00'57" W, a distance of 7.00 feet to the TRUE POINT OF BEGINNING.

Contains an area of 70 square feet, more or less.

EXHIBIT "E"

Page 2 of 2

APN 466-160-01T (portion)
Public landscape irrigation easement

PARCEL 8

A portion of that certain Court House Block as shown on the map of the Town (now City) of Fresno recorded in Volume 1 of Plats at Page 2, Fresno County Records, more particularly described as follows:

COMMENCING at the westerly corner of said block; thence N 48°59'57" E, along the northwesterly line of said block, a distance of 31.00 feet to a line parallel with and 31.00 feet northeasterly of the southwesterly line of said block; thence S 40°59'03" E, along said parallel line, a distance of 35.00 feet to the southeasterly right-of-way line of that portion of Fresno Street previously dedicated for public street purposes by that Grant of Easement recorded September 11, 1952, as Document No. 46385 in Book 3208 at Page 376, Official Records of Fresno County; thence S 40°59'03" E, along the northeasterly right-of-way line of that portion of Van Ness Avenue previously dedicated for public street purposes by that Grant of Easement recorded June 22, 1953, as Document No. 35387 in Book 3321 at Page 666, Official Records of Fresno County, parallel with and 31.00 feet northeasterly of the southwesterly line of said block, a distance of 521.35 feet; thence N 49°00'57" E, a distance of 22.61 feet to a point on a line parallel with and 53.61 feet northeasterly of the southwesterly line of said block, said point being the TRUE POINT OF BEGINNING of this description; thence S 40°59'03" E, along last said parallel line, a distance of 10.00 feet; thence N 49°00'57" E, a distance of 5.00 feet; thence N 40°59'03" W, parallel with and 58.61 feet northeasterly of the southwesterly line of said block, a distance of 10.00 feet; thence S 49°00'57" W, a distance of 5.00 feet to the TRUE POINT OF BEGINNING.

Contains an area of 50 square feet, more or less.

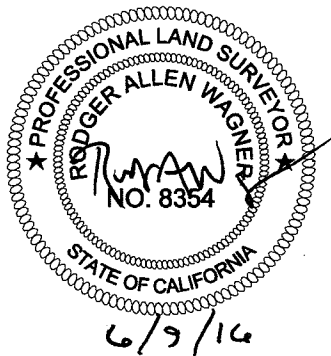
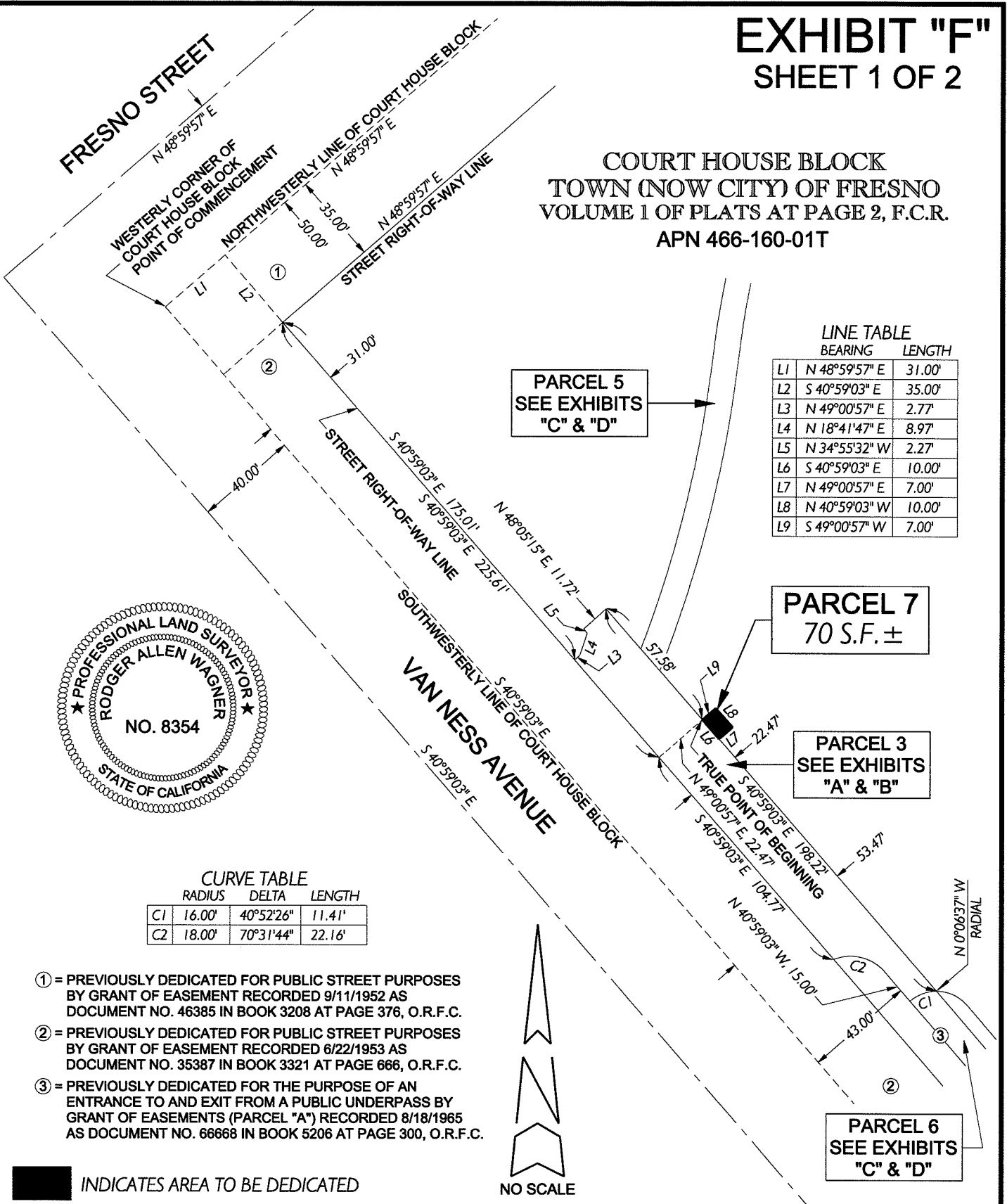

EXHIBIT "F"

SHEET 1 OF 2

COURT HOUSE BLOCK
TOWN (NOW CITY) OF FRESNO
VOLUME 1 OF PLATS AT PAGE 2, F.C.R.
APN 466-160-01T



LINE TABLE

	BEARING	LENGTH
L1	N 48°59'57" E	31.00'
L2	S 40°59'03" E	35.00'
L3	N 49°00'57" E	2.77'
L4	N 18°41'47" E	8.97'
L5	N 34°55'32" W	2.27'
L6	S 40°59'03" E	10.00'
L7	N 49°00'57" E	7.00'
L8	N 40°59'03" W	10.00'
L9	S 49°00'57" W	7.00'

CURVE TABLE

	RADIUS	DELTA	LENGTH
C1	16.00'	40°52'26"	11.41'
C2	18.00'	70°31'44"	22.16'

- ① = PREVIOUSLY DEDICATED FOR PUBLIC STREET PURPOSES BY GRANT OF EASEMENT RECORDED 9/11/1952 AS DOCUMENT NO. 46385 IN BOOK 3208 AT PAGE 376, O.R.F.C.
- ② = PREVIOUSLY DEDICATED FOR PUBLIC STREET PURPOSES BY GRANT OF EASEMENT RECORDED 6/22/1953 AS DOCUMENT NO. 35387 IN BOOK 3321 AT PAGE 666, O.R.F.C.
- ③ = PREVIOUSLY DEDICATED FOR THE PURPOSE OF AN ENTRANCE TO AND EXIT FROM A PUBLIC UNDERPASS BY GRANT OF EASEMENTS (PARCEL "A") RECORDED 8/18/1965 AS DOCUMENT NO. 66668 IN BOOK 5206 AT PAGE 300, O.R.F.C.

■ INDICATES AREA TO BE DEDICATED



REF. & REV. 2016-047 PLATS 2656 & 2756	CITY OF FRESNO DEPARTMENT OF PUBLIC WORKS	PROJ. ID. <u>FC00049</u> PCBU <u> </u> FAX <u> </u> FUND NO. <u>43532</u> ACT. ID <u> </u> PLANNING <u> </u> ORG. NO. <u>459901</u>	DR. BY <u>A.J.</u> CH. BY <u>R.A.W.</u> DATE <u>MAY 31, 2016</u> SCALE <u>NO SCALE</u>
PARCELS TO BE DEDICATED TO THE CITY OF FRESNO FOR LANDSCAPE IRRIGATION PURPOSES		SHEET NO. <u>7</u> OF <u>8</u> SHEETS 15-A-9260	

EXHIBIT "F"

SHEET 2 OF 2

COURT HOUSE BLOCK
 TOWN (NOW CITY) OF FRESNO
 VOLUME 1 OF PLATS AT PAGE 2, F.C.R.
 APN 466-160-01T

LINE TABLE
 BEARING LENGTH

LINE	BEARING	LENGTH
L1	N 48°59'57" E	31.00'
L2	S 40°59'03" E	35.00'
L3	N 49°00'57" E	2.50'
L4	N 78°55'00" E	9.40'
L5	S 40°59'03" E	2.80'
L6	S 40°59'03" E	10.00'
L7	N 49°00'57" E	5.00'
L8	N 40°59'03" W	10.00'
L9	S 49°00'57" W	5.00'

PARCEL 6
 SEE EXHIBITS
 "C" & "D"

PARCEL 4
 SEE EXHIBITS
 "A" & "B"

PARCEL 8
 50 S.F. ±



CURVE TABLE

	RADIUS	DELTA	LENGTH
C1	16.00'	41°31'59"	11.60'
C2	18.00'	70°31'44"	22.16'

- ① = PREVIOUSLY DEDICATED FOR PUBLIC STREET PURPOSES BY GRANT OF EASEMENT RECORDED 9/11/1952 AS DOCUMENT NO. 46385 IN BOOK 3208 AT PAGE 376, O.R.F.C.
- ② = PREVIOUSLY DEDICATED FOR PUBLIC STREET PURPOSES BY GRANT OF EASEMENT RECORDED 6/22/1953 AS DOCUMENT NO. 35387 IN BOOK 3321 AT PAGE 666, O.R.F.C.
- ③ = PREVIOUSLY DEDICATED FOR THE PURPOSE OF AN ENTRANCE TO AND EXIT FROM A PUBLIC UNDERPASS BY GRANT OF EASEMENTS (PARCEL "A") RECORDED 8/18/1965 AS DOCUMENT NO. 66668 IN BOOK 5206 AT PAGE 300, O.R.F.C.

INDICATES AREA TO BE DEDICATED

REF. & REV. 2016-047 PLATS 2656 & 2756	CITY OF FRESNO DEPARTMENT OF PUBLIC WORKS PARCELS TO BE DEDICATED TO THE CITY OF FRESNO FOR LANDSCAPE IRRIGATION PURPOSES	PROJ. ID. FC00049 PCBU FAX FUND NO. 43532 ACT. ID PLANNING ORG. NO. 459901	DR. BY AJ CH. BY R.A.W. DATE MAY 31, 2016 SCALE NO SCALE
		SHEET NO. 8 OF 8 SHEETS 15-A-9260	

Recording Requested By:
Public Works Department
City of Fresno
No Fee-Government Code Sections
G6103 and 27383

When Recorded, Mail To:
Public Works Department
City of Fresno
2600 Fresno Street, Room 4019
Fresno, CA 93721-3623
Attention: Right-of-way Section

Exhibit "2"

SPACE ABOVE THIS LINE FOR RECORDER'S USE

APN 466-160-01T (portions)

TEMPORARY CONSTRUCTION EASEMENT

The County of Fresno, a political subdivision of the State of California, GRANTOR, hereby GRANTS to the City of Fresno, a municipal corporation, GRANTEE, a one-year temporary easement and right-of-way for the construction of utilities and public bus stop improvements, including, but not limited to, concrete curbs, gutters, sidewalks, and driveway approaches, and appurtenant utilities in the public right-of-way adjacent to said temporary easement and right-of-way, on-site transitions to said improvements, and relocation or reconstruction of affected on-site facilities, hereinafter called "Construction", over, under, through and across that real property situated in the City of Fresno, County of Fresno, State of California, described and shown as follows:

See Exhibits "A" and "B", which are attached and incorporated herein

Grantee, its agents, employees, contractors and subcontractors and their employees shall have the right to enter upon and pass and re-pass over and along said real property and to deposit, store and use tools, implements and materials thereon whenever and where necessary for the purpose of performing said Construction. The term of this Temporary Construction Easement shall commence when Construction begins and shall terminate one year thereafter. Upon completion of Construction, the City of Fresno will restore the subject property to the original condition.

The County of Fresno, a political subdivision of the State of California

By: _____
Ernest Buddy Mendes, Chairman
Board of Supervisors

Dated: _____

EXHIBIT "A"

Page 1 of 2

APN 466-160-01T (portion)
Temporary construction easement

A portion of that certain Court House Block as shown on the map of the Town (now City) of Fresno recorded in Volume 1 of Plats at Page 2, Fresno County Records, more particularly described as follows:

COMMENCING at the westerly corner of said block; thence S 40°59'03" E, along the southwesterly line of said block, a distance of 35.00 feet to a line parallel with and 35.00 feet southeasterly of the northwesterly line of said block; thence N 48°59'57" E, along said parallel line, a distance of 31.00 feet to the northeasterly right-of-way line of that portion of Van Ness Avenue previously dedicated for public street purposes by that Grant of Easement recorded June 22, 1953, as Document No. 35387 in Book 3321 at Page 666, Official Records of Fresno County; thence N 48°59'57" E, along the southeasterly right-of-way line of that portion of Fresno Street previously dedicated for public street purposes by that Grant of Easement recorded September 11, 1952, as Document No. 46385 in Book 3208 at Page 376, Official Records of Fresno County, parallel with and 35.00 feet southeasterly of the northwesterly line of said block, a distance of 146.54 feet to the TRUE POINT OF BEGINNING of this description; thence continuing N 48°59'57" E, along said southeasterly right-of-way line, a distance of 5.00 feet; thence S 41°02'32" E, a distance of 24.00 feet; thence N 48°59'57" E, parallel with and 59.00 feet southeasterly of the northwesterly line of said block, a distance of 6.41 feet to the southwesterly line of a parcel designated as Parcel 2 and described in an unrecorded agreement dated June 20, 1989, between the City of Fresno and the County of Fresno to install and maintain a bus stop facility; thence S 41°02'32" E, along said southwesterly line, a distance of 2.00 feet to the south corner of said Parcel 2; thence N 48°59'57" E, along the southeasterly line of said Parcel 2, parallel with and 61.00 feet southeasterly of the northwesterly line of said block, a distance of 139.50 feet to the east corner of said Parcel 2; thence N 41°02'32" W, along the northeasterly line of said Parcel 2, a distance of 5.91 feet; thence N 48°59'57" E, parallel with the northwesterly line of said block, a distance of 14.55 feet; thence N 41°02'32" W, parallel with said northeasterly line of Parcel 2, a distance of 11.20 feet; thence N 48°59'57" E, parallel with the northwesterly line of said block, a distance of 19.29 feet to a point of cusp of a tangent curve concave northeasterly and having a radius of 4.05 feet; thence northwesterly and northerly, along the arc of said curve, through a central angle of 157°00'10", an arc distance of 11.09 feet; thence N 63°59'52" W, non-tangent to last said curve, a distance of 1.22 feet to said southeasterly right-of-way line of Fresno Street; thence N 49°01'51" E, along said southeasterly right-of-way line, a distance of 7.06 feet; thence S 40°58'09" E, a distance of 11.76 feet; thence S 18°51'30" W, a distance of 38.30 feet; thence S 48°59'57" W, parallel with and 66.00 feet southeasterly of the northwesterly line of said block, a distance of 156.62 feet; thence N 41°02'32" W, parallel with and 5.00 feet southwesterly of said southwesterly line of Parcel 2, a distance of 31.00 feet to the TRUE POINT OF BEGINNING.

Contains an area of 1,347 square feet, more or less.

EXHIBIT "A"

Page 2 of 2

APN 466-160-01T (portion)
Temporary construction easement

A portion of that certain Court House Block as shown on the map of the Town (now City) of Fresno recorded in Volume 1 of Plats at Page 2, Fresno County Records, more particularly described as follows:

COMMENCING at the westerly corner of said block; thence N 48°59'57" E, along the northwesterly line of said block, a distance of 31.00 feet to a line parallel with and 31.00 feet northeasterly of the southwesterly line of said block; thence S 40°59'03" E, along said parallel line, a distance of 35.00 feet to the southeasterly right-of-way line of that portion of Fresno Street previously dedicated for public street purposes by that Grant of Easement recorded September 11, 1952, as Document No. 46385 in Book 3208 at Page 376, Official Records of Fresno County; thence S 40°59'03" E, along the northeasterly right-of-way line of that portion of Van Ness Avenue previously dedicated for public street purposes by that Grant of Easement recorded June 22, 1953, as Document No. 35387 in Book 3321 at Page 666, Official Records of Fresno County, parallel with and 31.00 feet northeasterly of the southwesterly line of said block, a distance of 163.40 feet to the TRUE POINT OF BEGINNING of this description; thence continuing S 40°59'03" E, along said northeasterly right-of-way line, parallel with and 31.00 feet northeasterly of the southwesterly line of said block, a distance of 11.61 feet; thence N 49°00'57" E, a distance of 2.77 feet; thence N 18°41'47" E, a distance of 8.97 feet; thence N 34°55'32" W, a distance of 2.27 feet; thence N 48°05'15" E, a distance of 11.72 feet; thence S 40°59'03" E, parallel with and 53.47 feet northeasterly of the southwesterly line of said block, a distance of 57.58 feet; thence N 49°00'57" E, a distance of 7.00 feet; thence S 40°59'03" E, parallel with and 60.47 feet northeasterly of the southwesterly line of said block, a distance of 10.00 feet; thence S 49°00'57" W, a distance of 7.00 feet; thence S 40°59'03" E, parallel with and 53.47 feet northeasterly of the southwesterly line of said block, a distance of 130.64 feet; thence S 41°05'09" E, a distance of 78.08 feet; thence S 40°59'03" E, parallel with and 53.61 feet northeasterly of the southwesterly line of said block, a distance of 77.02 feet; thence N 49°00'57" E, a distance of 5.00 feet; thence S 40°59'03" E, parallel with and 58.61 feet northeasterly of the southwesterly line of said block, a distance of 10.00 feet; thence S 49°00'57" W, a distance of 5.00 feet; thence S 40°59'03" E, parallel with and 53.61 feet northeasterly of the southwesterly line of said block, a distance of 111.43 feet; thence S 49°00'57" W, a distance of 11.96 feet; thence N 40°59'03" W, a distance of 2.80 feet; thence S 78°55'00" W, a distance of 9.40 feet; thence S 49°00'57" W, a distance of 2.50 feet to said northeasterly right-of-way line of Van Ness Avenue; thence S 40°59'03" E, along said northeasterly right-of-way, a distance of 12.48 feet; thence N 49°00'57" E, a distance of 27.61 feet; thence N 40°59'03" W, parallel with and 58.61 feet northeasterly of the southwesterly line of said block, a distance of 111.43 feet; thence N 49°00'57" E, a distance of 5.00 feet; thence N 40°59'03" W, parallel with and 63.61 feet northeasterly of the southwesterly line of said block, a distance of 20.00 feet; thence S 49°00'57" W, a distance of 5.00 feet; thence N 40°59'03" W, parallel with and 58.61 feet northeasterly of the southwesterly line of said block, a distance of 275.74 feet; thence N 49°00'57" E, a distance of 6.86 feet; thence N 40°59'03" W, parallel with and 65.47 feet northeasterly of the southwesterly line of said block, a distance of 20.00 feet; thence S 49°00'57" W, a distance of 6.86 feet; thence N 40°59'03" W, parallel with and 58.61 feet northeasterly of the southwesterly line of said block, a distance of 57.66 feet; thence S 48°05'15" W, a distance of 27.61 feet to the TRUE POINT OF BEGINNING.

Contains an area of 2,910 square feet, more or less.

2016-047T
15-A-9260T

EXHIBIT "B"

SHEET 1 OF 3

LINE TABLE

	BEARING	LENGTH
L1	S 40°59'03" E	35.00'
L2	N 48°59'57" E	31.00'

WESTERLY CORNER OF COURT HOUSE BLOCK
POINT OF COMMENCEMENT
FOR ALL PARCELS

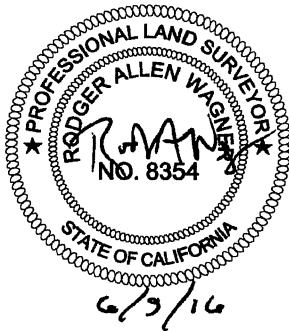

ANGLE POINT

FRESNO STREET
N 48°59'57" E

NORTHWESTERLY LINE OF COURT HOUSE BLOCK
PARCEL 1 TRUE POINT OF BEGINNING
N 48°59'57" E

STREET RIGHT-OF-WAY LINE
N 48°59'57" E

PARCEL 1
SEE SHEET 2

COURT HOUSE BLOCK
TOWN (NOW CITY) OF FRESNO
VOLUME 1 OF PLATS AT PAGE 2, F.C.R.

APN 466-160-01T

VAN NESS AVENUE
S 40°59'03" E
SOUTHWESTERLY LINE OF COURT HOUSE BLOCK
S 40°59'03" E

PARCEL 2
SEE SHEET 3

- A** = PARCEL TO BE DEDICATED AS A BUS STOP EASEMENT
- B** = PARCEL TO BE DEDICATED AS A BUS STOP UTILITY EASEMENT
- C** = PARCEL TO BE DEDICATED AS A LANDSCAPE IRRIGATION EASEMENT
- 1** = PREVIOUSLY DEDICATED FOR PUBLIC STREET PURPOSES BY GRANT OF EASEMENT RECORDED 9/11/1952 AS DOCUMENT NO. 46385 IN BOOK 3208 AT PAGE 376, O.R.F.C.
- 2** = PREVIOUSLY DEDICATED FOR PUBLIC STREET PURPOSES BY GRANT OF EASEMENT RECORDED 6/22/1953 AS DOCUMENT NO. 35387 IN BOOK 3321 AT PAGE 666, O.R.F.C.
- 3** = PREVIOUSLY DEDICATED FOR THE PURPOSE OF AN ENTRANCE TO AND EXIT FROM A PUBLIC UNDERPASS BY GRANT OF EASEMENTS (PARCEL "A") RECORDED 8/18/1965 AS DOCUMENT NO. 66668 IN BOOK 5206 AT PAGE 300, O.R.F.C.
- 4** = PUBLIC STREET VACATED BY CITY OF FRESNO RESOLUTION NO. 8576 RECORDED 8/12/1965 AS DOCUMENT NO. 69677 IN BOOK 5210 AT PAGE 614, O.R.F.C.
- 5** = UNRECORDED AGREEMENT DATED 6/20/1989 BETWEEN THE CITY AND COUNTY OF FRESNO TO RECONSTRUCT, MODIFY, EXPAND AND MAINTAIN A BUS STOP FACILITY (PARCELS 1 & 2)



REF. & REV.
2016-047T
PLATS 2656 & 2756

CITY OF FRESNO
DEPARTMENT OF PUBLIC WORKS

**PARCELS TO BE DEDICATED TO
THE CITY OF FRESNO AS
TEMPORARY CONSTRUCTION EASEMENTS**

PROJ. ID. FC00049 PCBU FAX
FUND NO. 43532 ACT. ID PLANNING
ORG. NO. 459901

DR. BY AJ SHEET NO. 1
CH. BY R.A.W. OF 3 SHEETS
DATE JUNE 1, 2016
SCALE NO SCALE 15-A-9260T

EXHIBIT "B"

SHEET 2 OF 3



LINE TABLE		
	BEARING	LENGTH
L1	S 40°59'03" E	35.00'
L2	N 48°59'57" E	31.00'
L3	S 41°02'32" E	2.00'
L4	N 41°02'32" W	5.91'
L5	N 48°59'57" E	14.55'
L6	N 41°02'32" W	11.20'
L7	N 48°59'57" E	19.29'
L8	N 63°59'52" W	1.22'
L9	N 49°01'51" E	7.06'
L10	S 40°58'09" E	11.76'

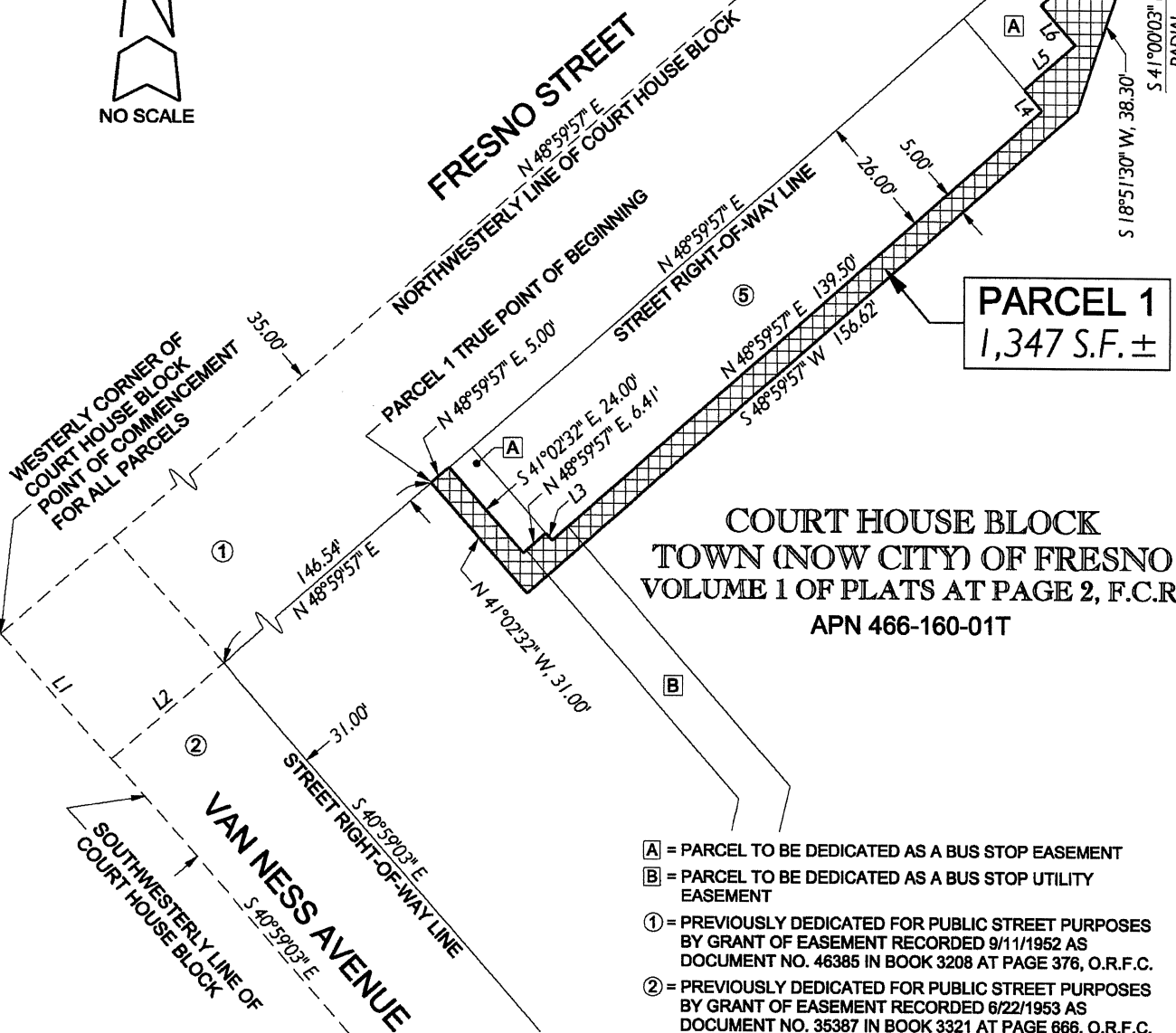
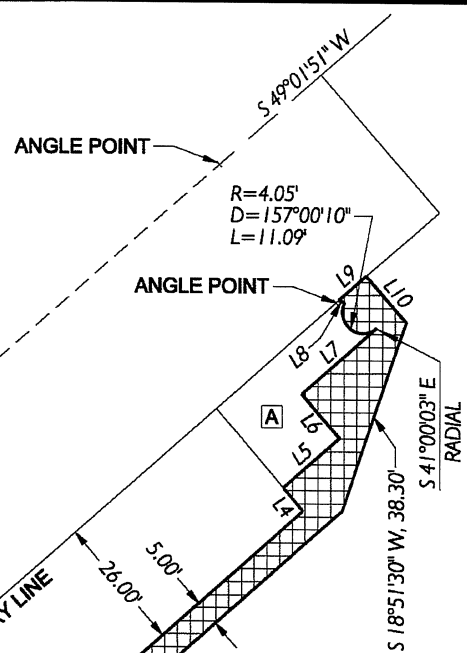

PARCEL 1
1,347 S.F. ±

COURT HOUSE BLOCK
TOWN (NOW CITY) OF FRESNO
VOLUME 1 OF PLATS AT PAGE 2, F.C.R.
APN 466-160-01T

- [A] = PARCEL TO BE DEDICATED AS A BUS STOP EASEMENT
- [B] = PARCEL TO BE DEDICATED AS A BUS STOP UTILITY EASEMENT
- ① = PREVIOUSLY DEDICATED FOR PUBLIC STREET PURPOSES BY GRANT OF EASEMENT RECORDED 9/11/1952 AS DOCUMENT NO. 46385 IN BOOK 3208 AT PAGE 376, O.R.F.C.
- ② = PREVIOUSLY DEDICATED FOR PUBLIC STREET PURPOSES BY GRANT OF EASEMENT RECORDED 6/22/1953 AS DOCUMENT NO. 35387 IN BOOK 3321 AT PAGE 666, O.R.F.C.
- ⑤ = UNRECORDED AGREEMENT DATED 6/20/1989 BETWEEN THE CITY AND COUNTY OF FRESNO TO RECONSTRUCT, MODIFY, EXPAND AND MAINTAIN A BUS STOP FACILITY (PARCELS 1 & 2)

INDICATES AREA TO BE DEDICATED

REF. & REV. 2016-047T PLATS 2656 & 2756	CITY OF FRESNO DEPARTMENT OF PUBLIC WORKS	PROJ. ID. <u>FC00049</u> PCBU FAX FUND NO. <u>43532</u> ACT. ID PLANNING ORG. NO. <u>459901</u>
	PARCELS TO BE DEDICATED TO THE CITY OF FRESNO AS TEMPORARY CONSTRUCTION EASEMENTS	DR. BY <u>AJ</u> SHEET NO. <u>2</u> CH. BY <u>R.A.W.</u> OF <u>3</u> SHEETS DATE <u>JUNE 1, 2016</u> SCALE <u>NO SCALE</u> 15-A-9260T

EXHIBIT "B"

SHEET 3 OF 3

COURT HOUSE BLOCK TOWN (NOW CITY) OF FRESNO VOLUME 1 OF PLATS AT PAGE 2, F.C.R. APN 466-160-01T

PARCEL 2
2,910 S.F. ±

LINE TABLE	
BEARING	LENGTH
L1	N 49°00'57" E 2.77'
L2	N 18°41'47" E 8.97'
L3	N 34°55'32" W 2.27'
L4	N 48°05'15" E 11.72'
L5	N 49°00'57" E 7.00'
L6	S 40°59'03" E 10.00'
L7	S 49°00'57" W 7.00'
L8	N 49°00'57" E 5.00'
L9	S 40°59'03" E 10.00'
L10	S 49°00'57" W 5.00'
L11	S 49°00'57" W 11.96'
L12	N 40°59'03" W 2.80'
L13	S 78°55'00" W 9.40'
L14	S 49°00'57" W 2.50'

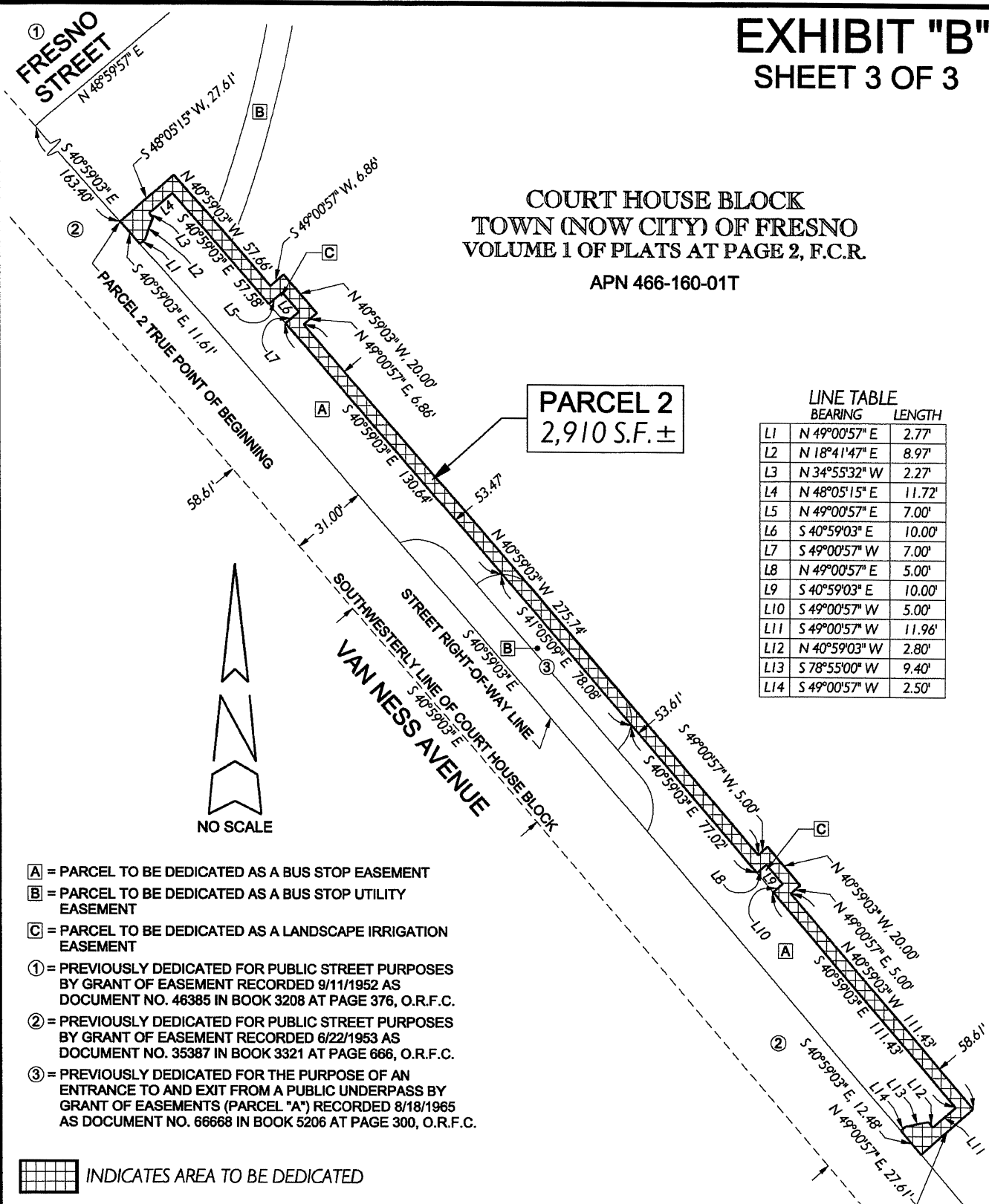

- [A] = PARCEL TO BE DEDICATED AS A BUS STOP EASEMENT
- [B] = PARCEL TO BE DEDICATED AS A BUS STOP UTILITY EASEMENT
- [C] = PARCEL TO BE DEDICATED AS A LANDSCAPE IRRIGATION EASEMENT
- ① = PREVIOUSLY DEDICATED FOR PUBLIC STREET PURPOSES BY GRANT OF EASEMENT RECORDED 9/11/1952 AS DOCUMENT NO. 46385 IN BOOK 3208 AT PAGE 376, O.R.F.C.
- ② = PREVIOUSLY DEDICATED FOR PUBLIC STREET PURPOSES BY GRANT OF EASEMENT RECORDED 6/22/1953 AS DOCUMENT NO. 35387 IN BOOK 3321 AT PAGE 666, O.R.F.C.
- ③ = PREVIOUSLY DEDICATED FOR THE PURPOSE OF AN ENTRANCE TO AND EXIT FROM A PUBLIC UNDERPASS BY GRANT OF EASEMENTS (PARCEL "A") RECORDED 8/18/1965 AS DOCUMENT NO. 66668 IN BOOK 5206 AT PAGE 300, O.R.F.C.

INDICATES AREA TO BE DEDICATED

REF. & REV.
2016-047T
PLATS 2656 & 2756

CITY OF FRESNO
DEPARTMENT OF PUBLIC WORKS

**PARCELS TO BE DEDICATED TO
THE CITY OF FRESNO AS
TEMPORARY CONSTRUCTION EASEMENTS**

PROJ. ID. <u>FC00049</u>	PCBU	FAX
FUND NO. <u>43532</u>	ACT. ID	PLANNING
ORG. NO. <u>459901</u>		
DR. BY <u>AJ</u>	SHEET NO. <u>3</u>	
CH. BY <u>R.A.W.</u>	OF <u>3</u> SHEETS	
DATE <u>JUNE 1, 2016</u>	15-A-9260T	
SCALE <u>NO SCALE</u>		