

MOBILE COMMAND VEHICLE
MANUFACTURER STOCK PHOTOS
(NOT ACTUAL VEHICLE)

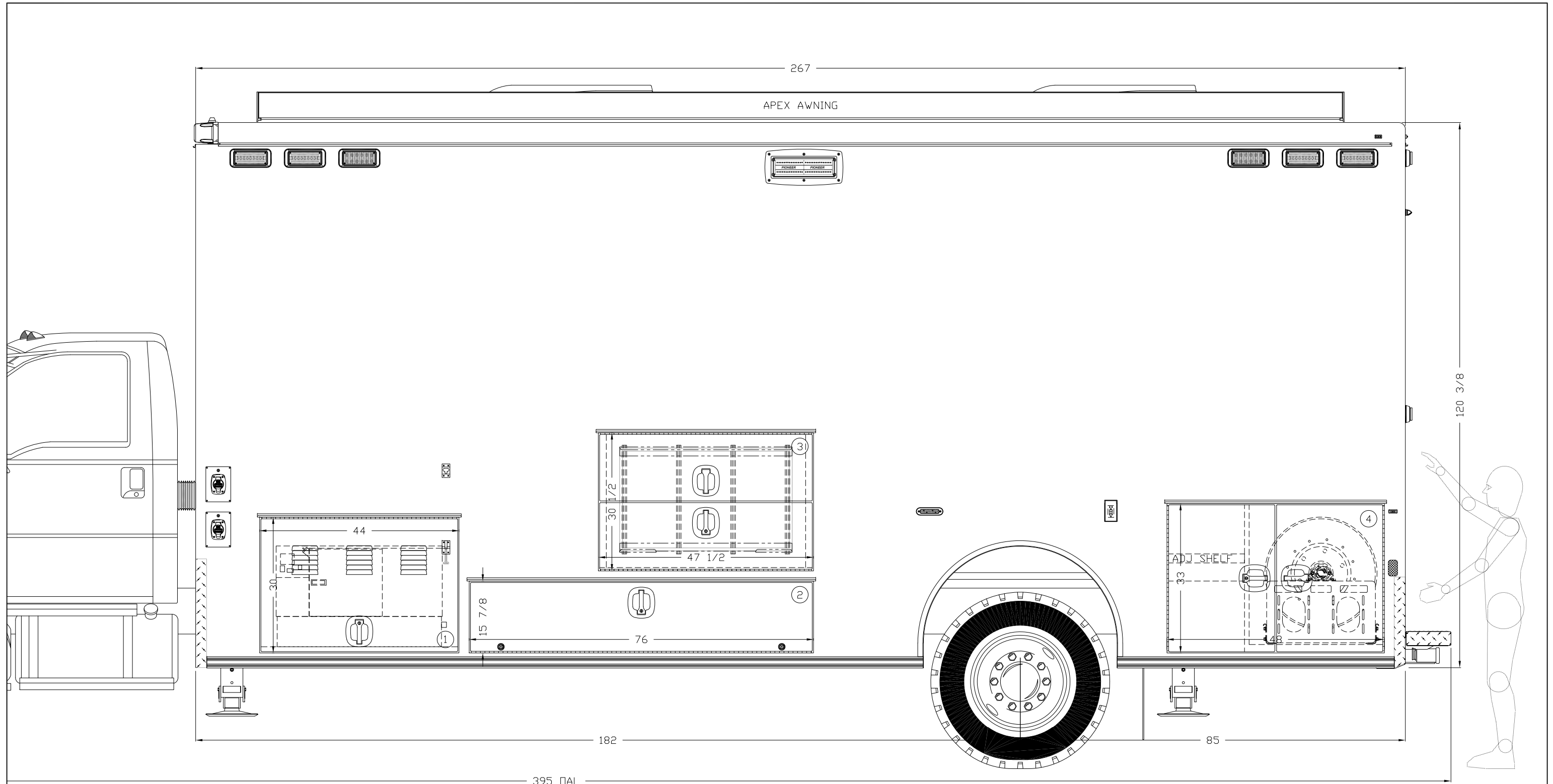



Braun Northwest, Inc.			
Department	SALES		Rev
Dwg. Name	FRESNO_P_CMND		
Client	FRESNO P.D.		
Date	08/16/2022	Drawing By	T.D.B.

TITLE: EXTERIOR S/S VIEW

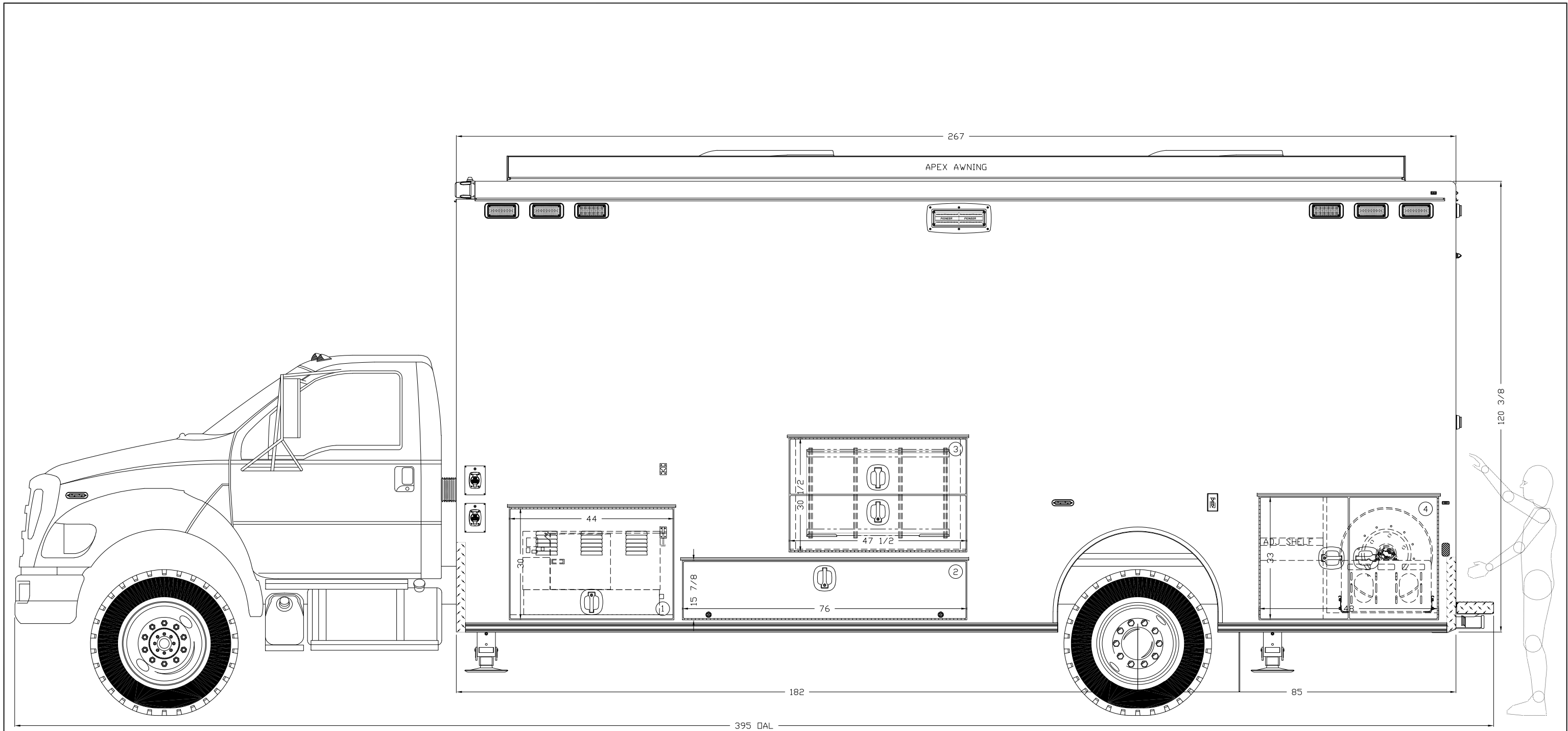

Braun Northwest, Inc.			
Department	SALES		Rev
Dwg. Name	FRESNO_P_CMND		
Client	FRESNO P.D.		
Date	08/16/2022	Drawing By	T.D.B.

TITLE: EXTERIOR S/S VIEW

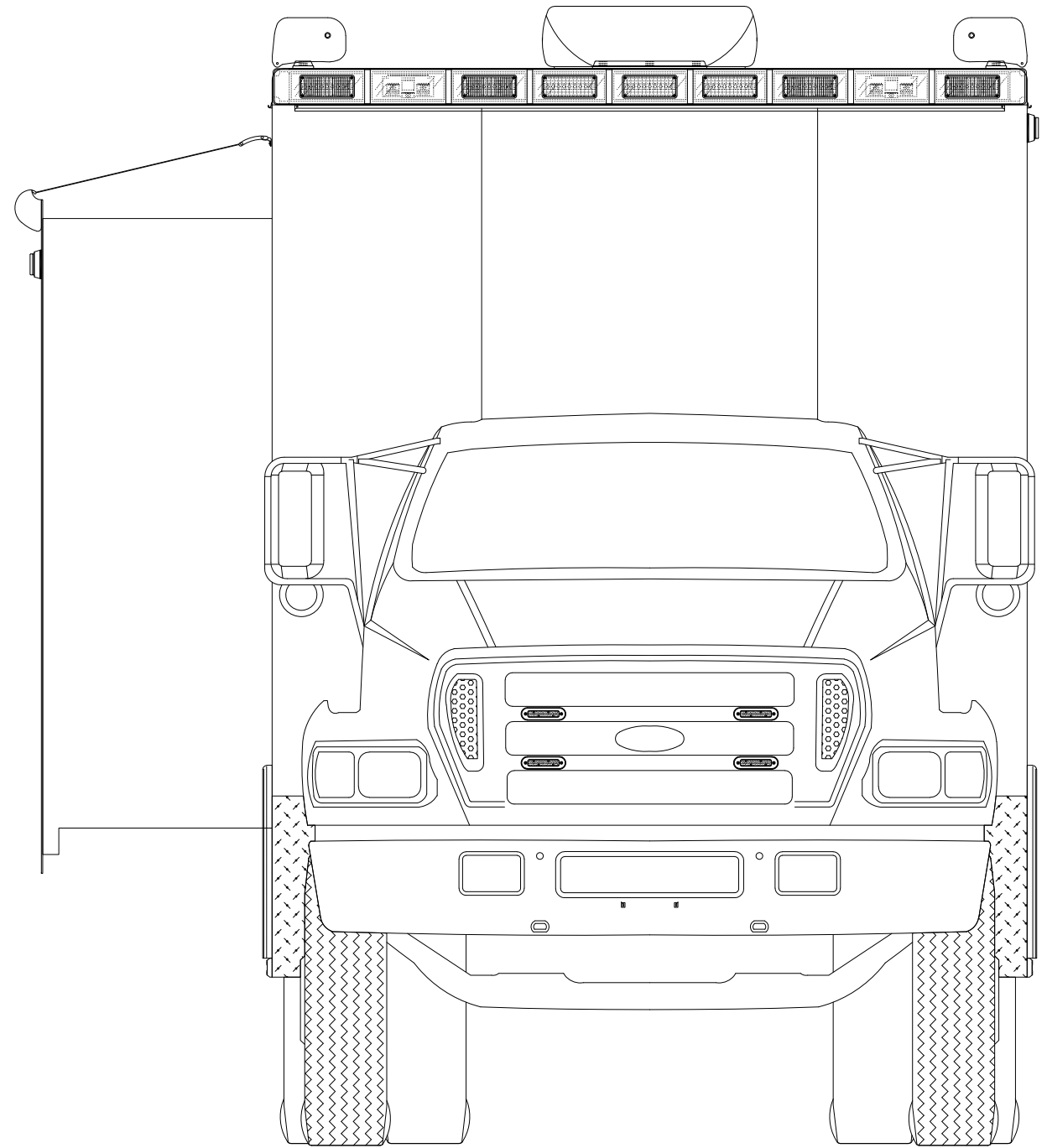
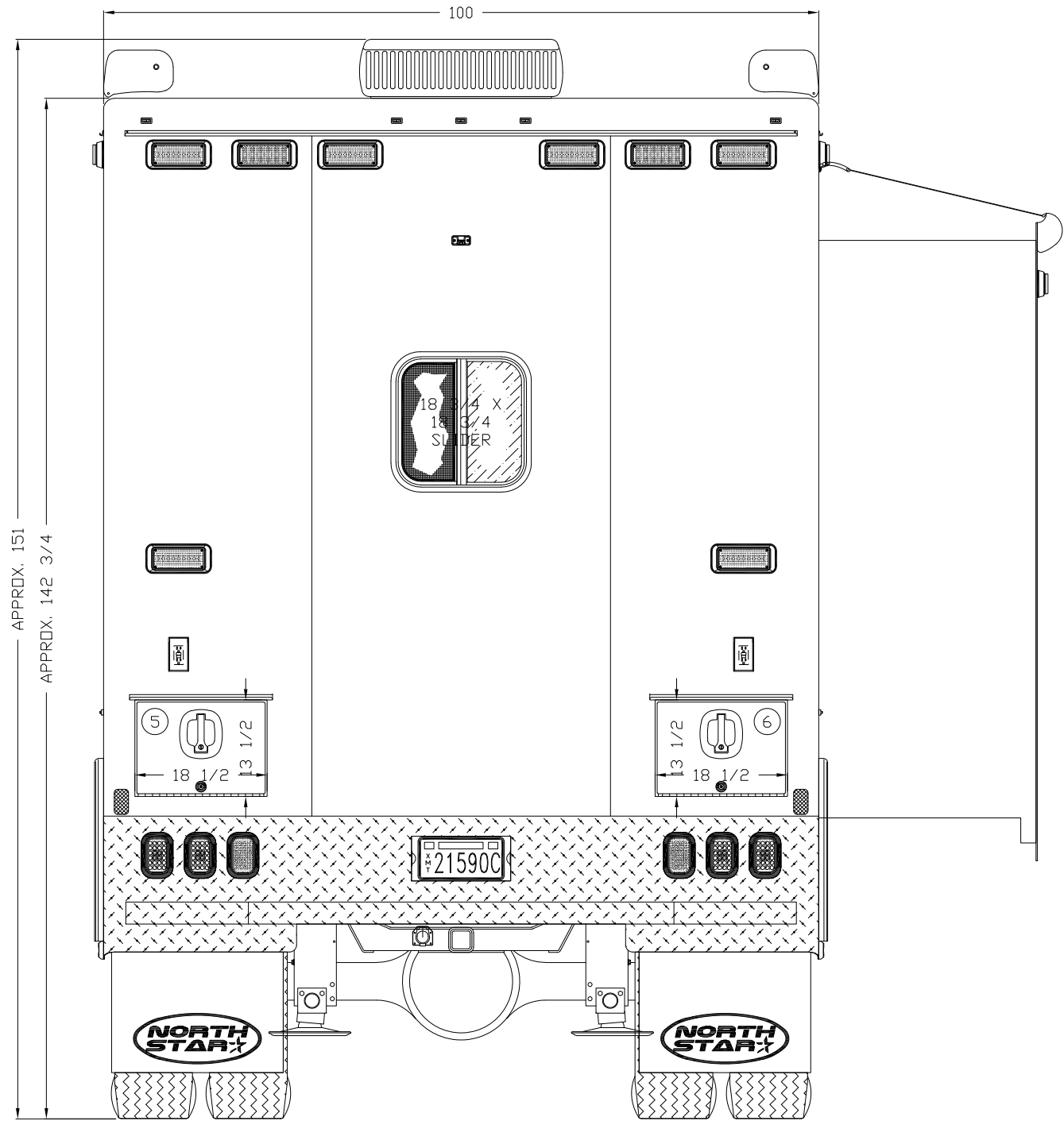

Braun Northwest, Inc.			
Department	SALES		Rev
Dwg. Name	FRESNO_PD_CMND2_4		
Client	FRESNO P.D.		
Date	08/16/2022	Drawing By	T.D.B.

TITLE: EXTERIOR REAR / FRONT VIEW

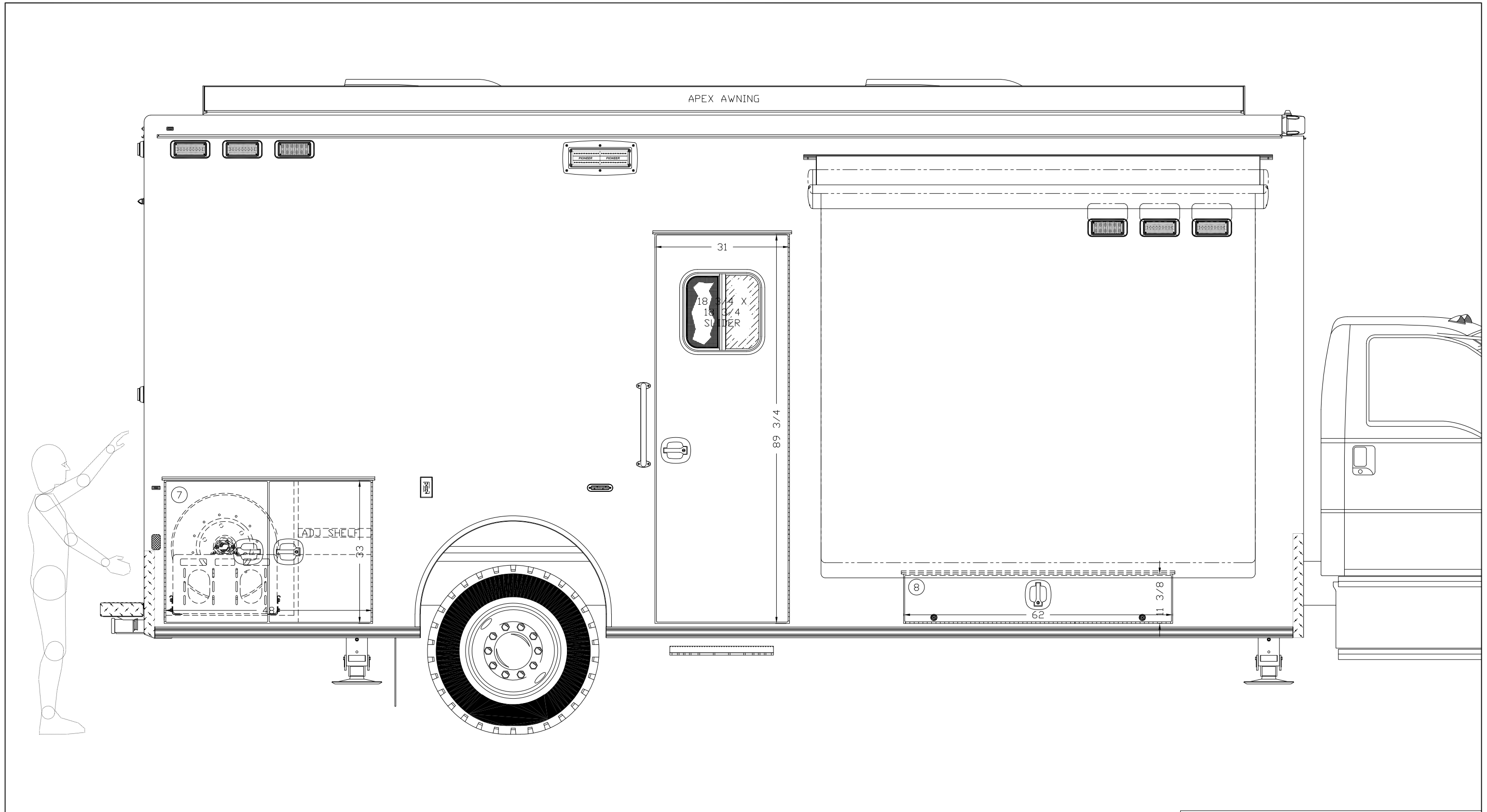

Braun Northwest, Inc.			
Department	SALES		Rev
Dwg. Name	FRESNO_PD_CMND3		
Client	FRESNO P.D.		
Date	08/16/2022	Drawing By	T.D.B.

TITLE: EXTERIOR C/S VIEW

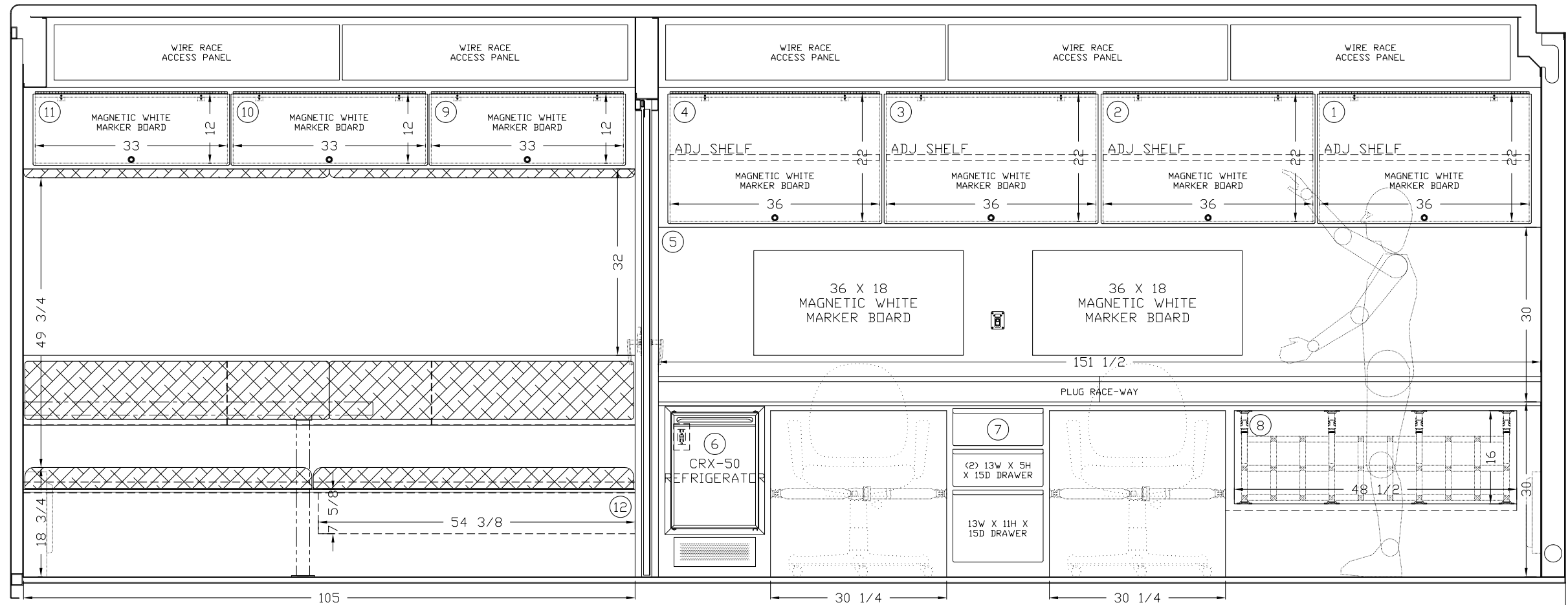

Braun Northwest, Inc.			
Department	SALES		Rev
Dwg. Name	FRESNO_PD_CMND5		
Client	FRESNO P.D.		
Date	08/16/2022	Drawing By	T.D.B.

TITLE: INTERIOR S/S VIEW

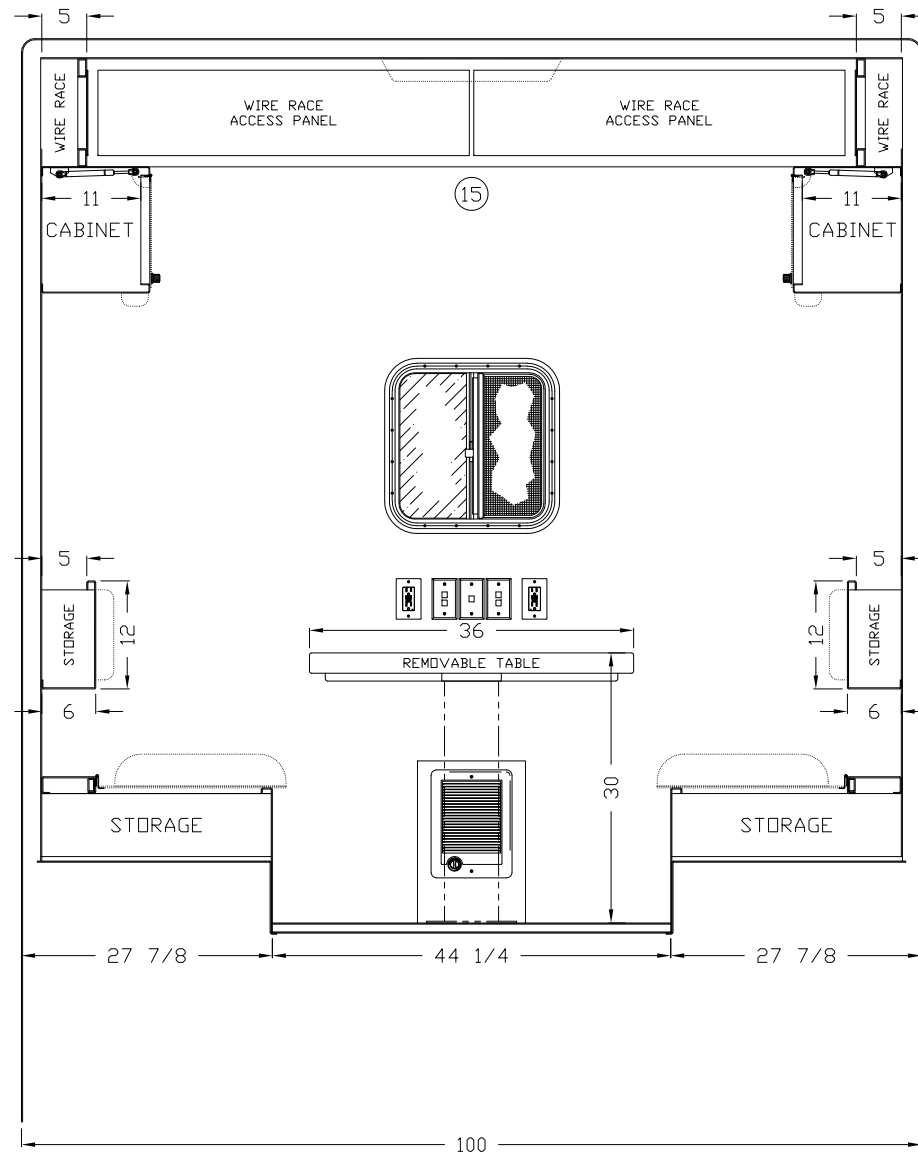

SECTION A - A AFT REAR VIEW

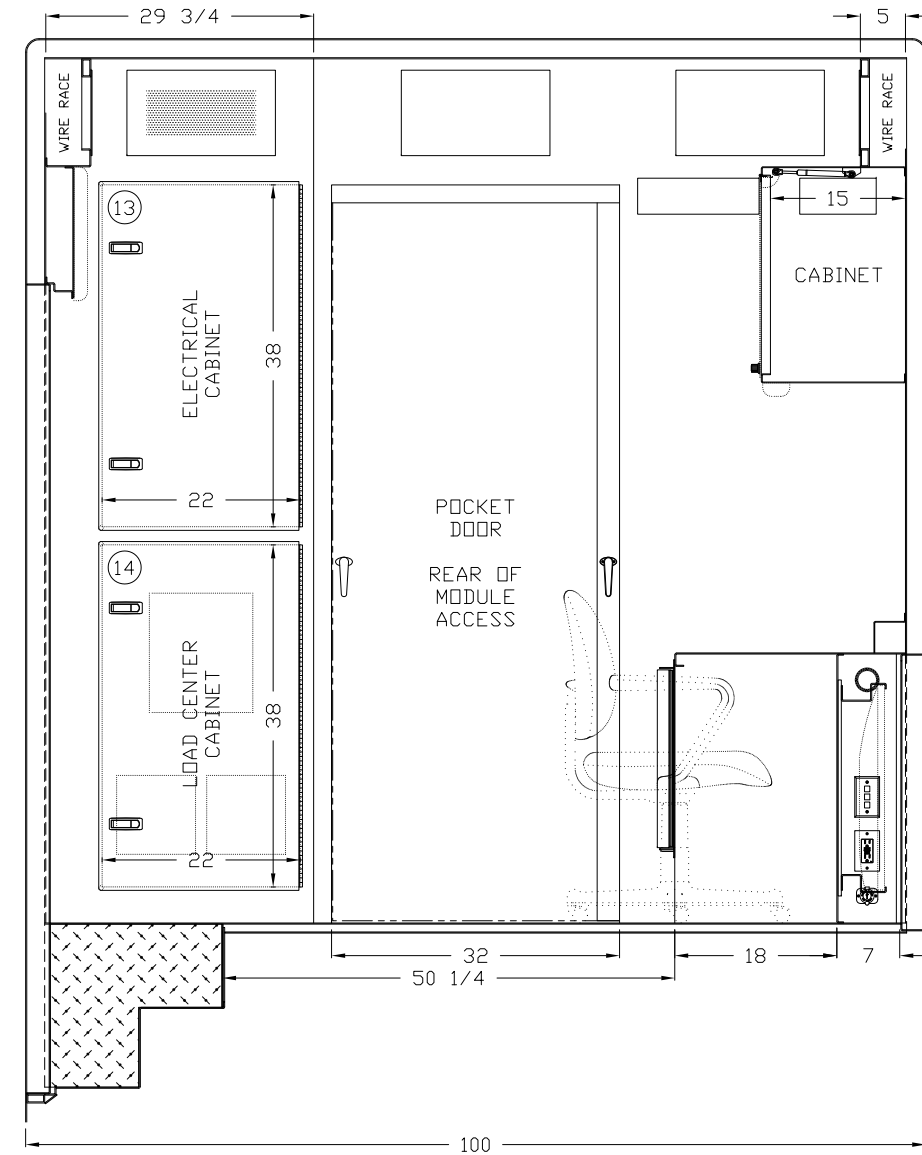

SECTION B - B MIDDLE REAR VIEW

Braun Northwest, Inc.

Department	SALES	Rev
Dwg. Name	FRESNO_PD_CMND6	
Client	FRESNO P.D.	
Date	08/16/2022	Drawing By T.D.B.

TITLE: INTERIOR REAR VIEW

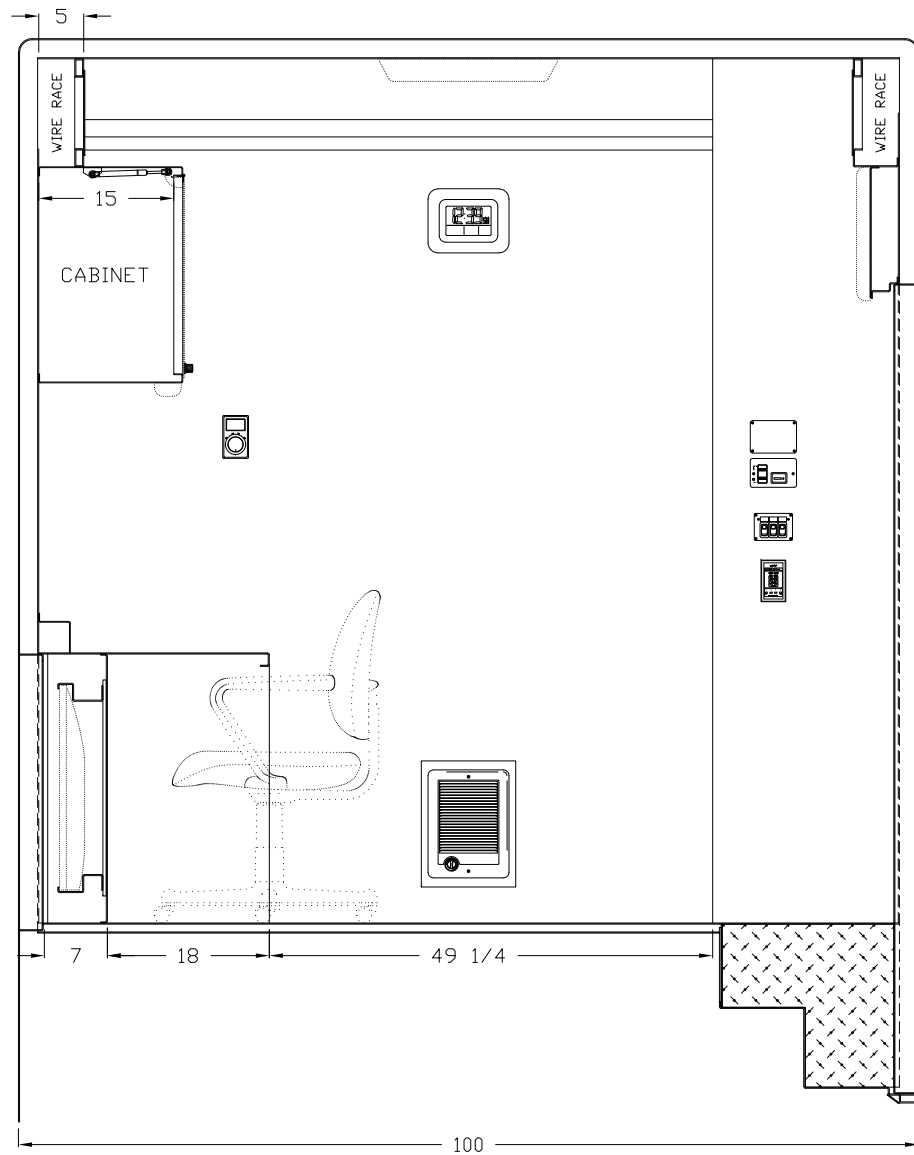

SECTION C - C MIDDLE FRONT VIEW

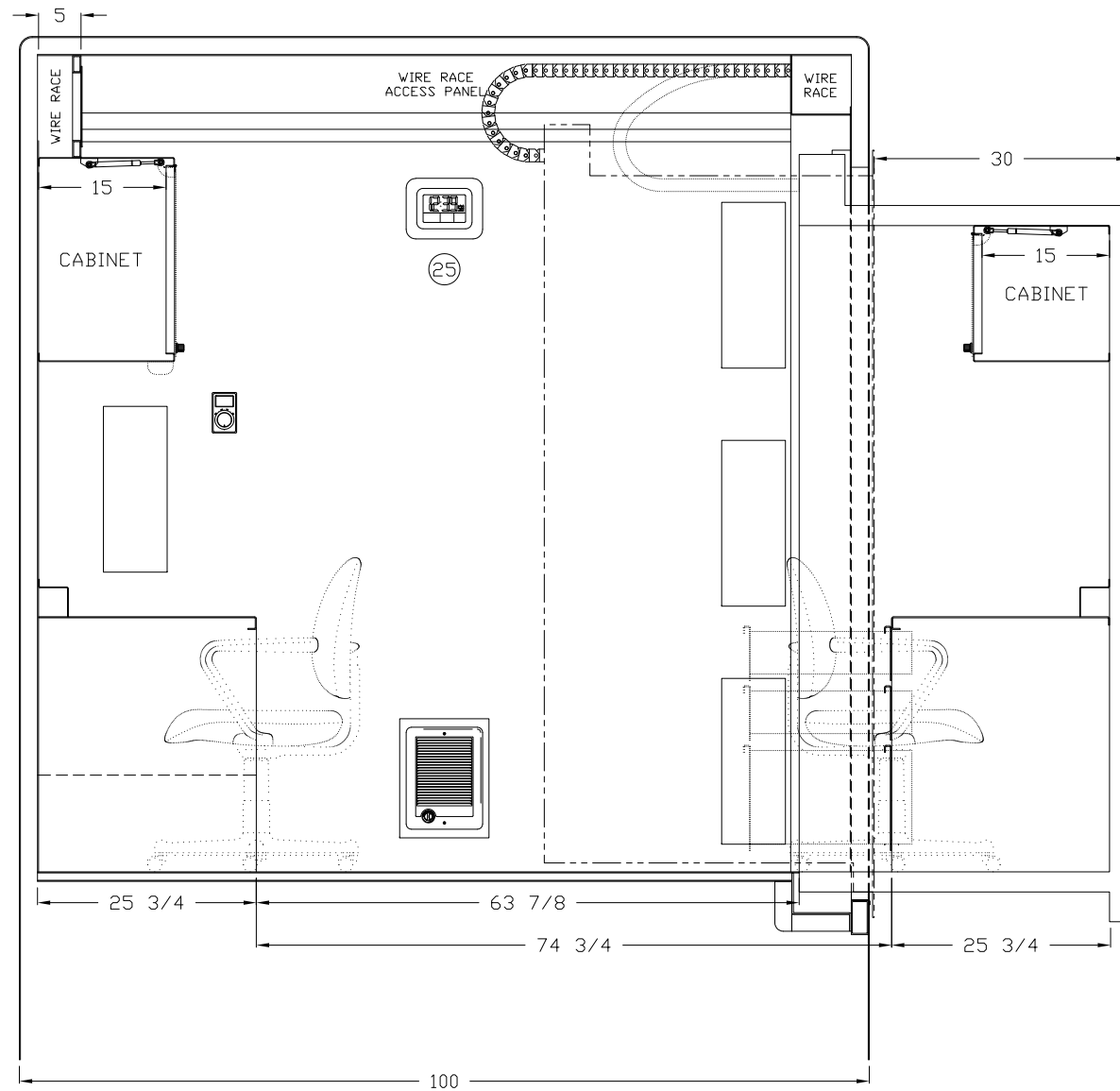

SECTION D - D FORWARD FRONT VIEW

Braun Northwest, Inc.			
Department	SALES		Rev
Dwg. Name	FRESNO_PD_CMND8		
Client	FRESNO P.D.		
Date	08/16/2022	Drawing By	T.D.B.

TITLE: INTERIOR FRONT VIEW

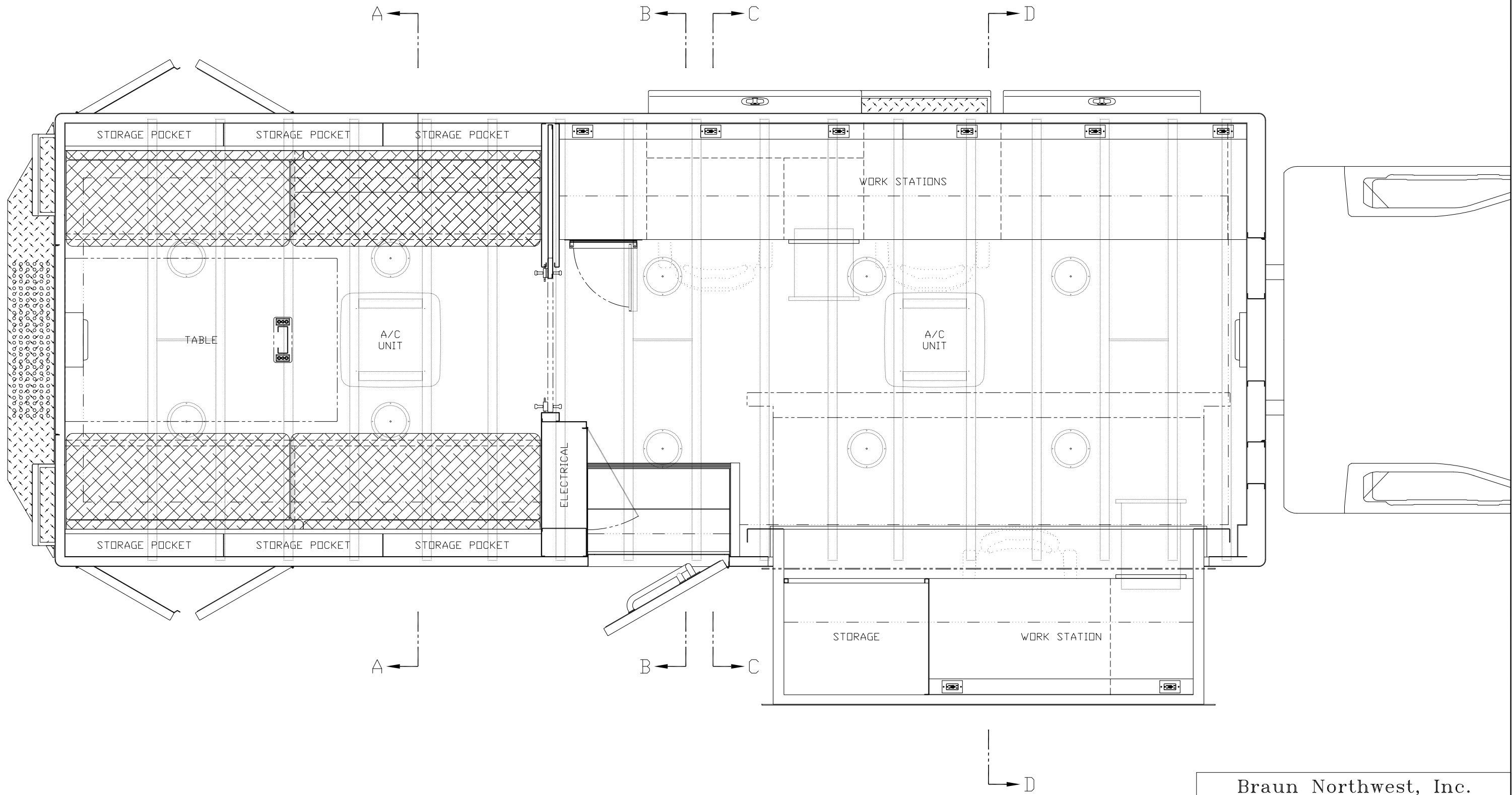

Braun Northwest, Inc.			
Department	SALES		Rev
Dwg. Name	FRESNO_PD_CMND9		
Client	FRESNO P.D.		
Date	08/16/2022	Drawing By	T.D.B.

TITLE: PLAN VIEW